

**IT** Catalogo prodotti  
**EN** Product catalogue  
**FR** Catalogue des produits  
**DE** Produktkatalog







---

**CATALOGO PRODOTTI  
PRODUCT CATALOGUE  
CATALOGUE DES PRODUITS  
PRODUKTKATALOG**



**1961 - 2021**

# CASTEL

## L'AZIENDA E I PRODOTTI THE COMPANY AND THE PRODUCTS L'ENTREPRISE ET LES PRODUITS DAS UNTERNEHMEN UND DIE PRODUKTE

Castel, leader nel settore della componentistica per la refrigerazione e il condizionamento dell'aria, è una Family Company di proprietà interamente italiana che a partire dal 1961 è cresciuta e si è consolidata, grazie ad una spiccata ricerca di innovazione e ad un costante desiderio di sbocco commerciale nazionale, ma anche internazionale.

**Mission** dell'azienda è supportare la crescita della clientela con prodotti affidabili, duraturi, di qualità e tecnologicamente avanzati, fabbricati nel rispetto dell'ambiente, sostenuti ed arricchiti da livelli di servizio superiori agli standard di settore, per consolidare il marchio Castel nei mercati già serviti e per creare visibilità nei mercati emergenti.

Castel è presente in oltre 90 paesi del mondo, nei 5 continenti. Per sostenere lo sviluppo nel contesto internazionale, la Castel ha aperto nel 2010 una consociata in Cina, "*Castel Refrigeration (Shanghai) Co., Ltd*", permettendo di avere una piattaforma logistica e di sviluppo commerciale per l'intero continente Asiatico e Pacifico. Recente è la costituzione di una consociata negli Stati Uniti, "*Castel USA, Inc.*", per lo sviluppo commerciale e logistico dell'azienda in tutto il continente americano.

Castel è fra le prime industrie italiane del settore ad aver ottenuto la certificazione del sistema qualità aziendale, rilasciata da TÜV SÜD in conformità alla norma EN ISO 9001:2015, e successivamente ha ottenuto anche la certificazione del sistema di gestione ambientale, sempre con TÜV SÜD, in conformità alla norma EN ISO 14001:2015. L'azienda si è dotata anche di numerose certificazioni di prodotto, in conformità a Direttive e Marchi di Qualità europei (es. VDE) ed extraeuropei (es. "UL", "EAC").

Da anni la Castel è costantemente impegnata a seguire l'evoluzione del mercato dei refrigeranti che si sta modificando in funzione dei vari protocolli d'intesa internazionali miranti ad un contenimento delle emissioni nocive e a una riduzione del riscaldamento globale. L'applicazione nell'Unione Europea del Regolamento F-Gas e di analoghe legislazioni nei principali paesi extraeuropei sta portando ad una progressiva riduzione, fino all'abbandono, di molti refrigeranti tradizionali a favore di refrigeranti sintetici alternativi o refrigeranti naturali.

Per dare una risposta a questa evoluzione del mercato da qualche anno la Castel ha intrapreso una progressiva ristrutturazione della propria offerta produttiva e con l'attuale catalogo è lieta di presentare alla propria clientela le seguenti linee di prodotto

- **GOGREEN:** prodotti specificamente realizzati per il refrigerante R744 appartenente al gruppo di sicurezza A1 così come definiti nella ASHRAE STANDARD 34-2019.
- **POLYHEDRA:** nuovi prodotti compatibili con la più ampia gamma possibile di refrigeranti appartenenti ai gruppi di sicurezza A1, A2L e A3 così come definiti nella ASHRAE STANDARD 34-2019
- **CLASSIC:** prodotti tradizionali, già presenti nei precedenti cataloghi, compatibili con i refrigeranti appartenenti al gruppo di sicurezza A1 così come definiti nella ASHRAE STANDARD 34-2019

Castel, a leading supplier of refrigeration and air conditioning components, is a 100% Italian-owned family-run company which has grown and established a name for itself since 1961, thanks to its outstanding pursuit of innovation and unwavering desire to conquer markets not only in Italy, but also abroad.

### **Mission**

Supporting an increase in our customer base with reliable, durable, high quality and technologically-advanced products, manufactured with respect for the environment, and supported and improved upon by levels of service that exceed industry standards, in order to consolidate the Castel brand's presence in its existing markets, and make the brand known in emerging ones.

Castel is now present in more than 90 countries on 5 continents. In 2010, Castel opened an associated company in China, "*Castel Refrigeration (Shanghai) Co., Ltd*", to support development in these countries, creating a logistics and commercial development platform for the entire Asian continent and the Pacific. Recently, an associated company in the United States, "*Castel USA, Inc.*", was established to support commercial and logistic development in the Americas.

Castel was one of the first Italian companies in the sector to obtain Business Quality System Certification issued by TÜV SÜD according to EN ISO 9001:2015 standard before subsequently receiving certification also for its Environmental Management System from TÜV SÜD according to EN ISO 14001:2015 standard. The company has also obtained several product certifications in conformity with European Directives and Certification Marks (e.g. VDE) and extra-European (e.g. "UL", "EAC") Quality Approvals.

Castel has dedicated constant attention for years to the evolution of the refrigerant market in adapting to international protocols aimed at reducing harmful emissions and global warming. The implementation in the European Union of the so-called F-Gas Regulation and similar legislation in important extra-European nations is leading to a progressive reduction and abandonment of many traditional refrigerants in favor of alternative synthetic or natural refrigerants. In response to these developments in the market, in recent years Castel has progressively restructured its offer and is now proud to offer its clients this catalog with the following lines of product:

- **GOGREEN:** Products developed specifically for refrigerant R744 within the A1 security group according to ASHRAE STANDARD 34-2019
- **POLYHEDRA:** New products compatible with the widest possible range of refrigerants classified A1, A2L and A3 according to ASHRAE STANDARD 34-2019
- **CLASSIC:** Traditional products featured in previous catalogs compatible with refrigerants classified A1 according to ASHRAE STANDARD 34-2019





Leader dans le secteur des composants pour la réfrigération et l'air conditionné, Castel est une entreprise familiale 100 % italienne qui, à partir de 1961, a grandi et s'est consolidée grâce à un remarquable effort d'innovation et à une recherche constante de débouchés commerciaux tant sur le marché domestique que sur les marchés internationaux.

**La mission** de l'entreprise consiste à: soutenir la croissance de la clientèle avec des produits fiables, durables, de qualité et technologiquement avancés, *fabriqués dans le respect de l'environnement*, renforcés par un niveau de service supérieur aux standards du secteur afin de consolider l'image de marque de Castel sur les marchés existants et afin de créer une visibilité de l'entreprise sur les marchés émergents.

Castel est actuellement présente dans plus de 90 pays répartis sur les 5 continents. Pour accompagner son développement à l'international, Castel a ouvert une filiale en Chine en 2010, « *Castel Refrigeration (Shanghai) Co., Ltd* », permettant ainsi à l'entreprise d'avoir une plateforme de développement logistique et commercial pour l'ensemble du continent asiatique et pacifique. La création d'une filiale aux États-Unis est récente, « *Castel USA, Inc.* ». Elle offre ainsi à l'entreprise une base lui permettant d'assurer le développement commercial et logistique de la société sur tout le continent américain.

Castel fait partie des premières industries italiennes du secteur à avoir obtenu la certification du système qualité de l'entreprise, délivrée par TÜV SÜD conformément à la norme EN ISO 9001:2015. Elle a ensuite obtenu la certification de son système de management environnemental, toujours auprès de TÜV SÜD, conformément à la norme EN ISO 14001:2015. La société est également titulaire de nombreuses certifications de produits, conformes aux directives et aux labels de qualité européens (tels qu'à titre d'exemple, VDE) et non européennes (tels que « UL », ou « EAC »).

Depuis plusieurs années, Castel suit en permanence l'évolution du marché des réfrigérants, qui est se trouve en constante évolution du fait de différents protocoles d'accords internationaux visant à limiter les émissions nocives et à réduire le réchauffement de la planète. L'application dans l'Union européenne du règlement sur les gaz fluorés et de législations similaires dans les principaux pays non européens conduit à une réduction progressive, jusqu'à l'abandon, de nombreux réfrigérants traditionnels au profit de réfrigérants de synthèse ou naturels. Pour répondre à cette évolution du marché depuis plusieurs années, Castel a entrepris une restructuration progressive de son offre de production et, avec son nouveau catalogue, l'entreprise se félicite de pouvoir présenter à ses clients les gammes de produits suivantes:

- **GOGREEN:** Des produits spécialement conçus pour le réfrigérant R744 appartenant au groupe de sécurité A1 aux termes des dispositions de la norme ASHRAE STANDARD 34-2019
- **POLYHEDRA:** De nouveaux produits compatibles avec la gamme la plus diversifiée possible de fluides frigorigènes appartenant aux groupes de sécurité A1, A2L et A3 tels que définis par la norme ASHRAE STANDARD 34-2019
- **CLASSIC:** Des produits traditionnels, comme on peut déjà les retrouver dans les catalogues précédents, compatibles avec les fluides frigorigènes appartenant au groupe de sécurité A1 tel que défini dans la norme ASHRAE STANDARD 34-2019

Castel, ein führendes Unternehmen im Bereich der Bauteile für Kühl- und Klimaanlage, ist ein Familienbetrieb, der sich vollständig in italienischem Besitz befindet, seit 1961 stets gewachsen ist und sich durch sein ausgeprägtes Engagement in Forschung und Innovation verbunden mit dem ständigen Streben nach einer Durchsetzung auf dem nationalen, aber auch auf dem internationalen Markt behauptet hat.

**Die Mission** des Unternehmens ist es, das Wachstum unserer Kunden zu unterstützen, indem wir verlässliche und dauerhafte Qualitätsprodukte liefern, die auf dem neuesten Stand der Technik und *im Einklang mit der Umwelt gefertigt wurden* und indem wir Serviceleistungen anbieten, die über das übliche Niveau der Branche hinausgehen, um den Namen Castel auf bestehenden Märkten zu stärken und ebenso auf neuen aufkommenden Märkten bekannt zu machen.

Castel ist in mehr als 90 Ländern auf 5 Kontinenten vertreten. Zur Unterstützung der internationalen Entwicklung mit einer Plattform für Logistik und Handel für den gesamten asiatischen Kontinent und den Pazifikraum hat Castel im Jahr 2010 die chinesische Tochtergesellschaft „*Castel Refrigeration (Shanghai) Co., Ltd*“ gegründet.

Kürzlich wurde in den Vereinigten Staaten eine weitere Tochtergesellschaft, die „*Castel USA, Inc.*“, gegründet, um die logistische und geschäftliche Entwicklung auf dem amerikanischen Kontinent zu unterstützen.

Castel zählt mit zu den ersten italienischen Industriebetrieben der Branche, die sich ihr Qualitätssicherungssystem nach EN ISO 9001:2015 durch den TÜV SÜD zertifizieren lassen und etwas später, stets durch den TÜV SÜD, auch das Umweltmanagementsystem nach EN ISO 14001:2015. Daneben ist das Unternehmen im Besitz zahlreicher Produktzertifikationen gemäß den europäischen und außereuropäische Richtlinien und Gütesiegeln (z. B. VDE bzw. UL, EAC).

Seit Jahren schon hat Castel den Markt für Kältemittel, der sich im Gefolge der verschiedenen internationalen Vereinbarungen zur Verringerung der Schadstoffemissionen und der Beschränkung der weltweiten Erwärmung verändert, permanent im Auge. Die Anwendung der F-Gase-Verordnung in der Europäischen Union und analoger gesetzlicher Vorgaben in den wichtigsten außereuropäischen Ländern führt zu einer progressiven Reduzierung bis hin zur völligen Aufgabe vieler herkömmlicher Kältemittel zugunsten alternativer synthetischer oder natürlicher Kältemittel. Als Antwort auf diese Marktentwicklung hat Castel vor einigen Jahren damit begonnen, sein Angebot neu auszurichten und freut sich, seinen Kunden mit dem neuen Katalog folgende Produktlinien präsentieren zu können:

- **GOGREEN:** Produkte, speziell für das Kältemittel R744 der Sicherheitsgruppe A1 laut Definition im ASHRAE STANDARD 34-2019.
- **POLYHEDRA:** Neue Produkte, die kompatibel sind mit einer möglichst großen Palette von Kältemitteln der Sicherheitsgruppen A1, A2L und A3 laut Definition im ASHRAE STANDARD 34-2109
- **CLASSIC:** Herkömmliche Produkte, die schon in unseren früheren Katalogen vertreten waren und kompatibel sind mit Kältemitteln der Sicherheitsgruppe A1 laut Definition im ASHRAE STANDARD 34-2019

## CONDIZIONI GENERALI DI VENDITA

### Ordini

Gli ordini presuppongono, da parte del cliente, l'accettazione integrale delle condizioni di vendita di Castel elencate di seguito e non impegnano Castel alle condizioni di acquisto dell'acquirente, fatta salva l'esistenza in vigore di condizioni particolari stipulate e firmate tra Castel ed il Cliente

### Spedizioni

La consegna merci è EX WORKS - EXW "Magazzino Castel di Vimercate (MB)" Incoterms® 2020, per le merci trasferite all'interno del territorio della Comunità Europea, viceversa, FREE CARRIER - FCA "Magazzino Castel di Vimercate (MB)" Incoterms® 2020, per le merci destinate al di fuori del territorio doganale della Comunità Europea.

### Imballi

Gli imballi sono fatturati al prezzo di costo e non sono accettati di ritorno.

### Consegne

I termini di consegna non sono impegnativi nei confronti di Castel: non è quindi accettato alcun addebito di responsabilità o penalità per ritardi di consegna. Eventuali ritardi non danno diritto alla risoluzione del contratto.

### Pagamenti

I ritardi di pagamento danno a Castel il diritto alla sospensione delle forniture e allo scioglimento dei contratti in corso.

### Reclami

In genere valgono solamente i reclami inoltrati presso la nostra sede entro dieci giorni dalla ricezione dei materiali. Eventuali difetti di fabbrica e simili che si rivelassero durante l'uso e dopo lo scadere dei dieci giorni, saranno considerati secondo i termini del paragrafo "garanzia". Non spetta alcuna garanzia di buon funzionamento se non in base a una clausola specifica convenuta per iscritto.

### Garanzia

Tutti i prodotti Castel sono garantiti per un periodo di 12 mesi a partire dalla data del documento di trasporto. La garanzia riguarda tutti quei prodotti o parti di essi che risultino presentare difetti di fabbricazione entro il periodo della garanzia stessa. I vizi o difetti devono essere denunciati nei termini previsti dalla legge italiana. Il cliente dovrà in questo caso, a sue spese salvo riconoscimento del costo in caso di difettosità accertata, rimandare i materiali unitamente a una descrizione dettagliata dei difetti riscontrati. La garanzia non è riconosciuta, quando i difetti dei prodotti Castel risultino dovuti a errori del cliente o di terzi quali: installazioni errate, usi contrari alle indicazioni fornite dal Castel, manomissioni. Per eventuali difetti o vizi dei propri prodotti, Castel si impegna alla pura e semplice sostituzione degli stessi senza riconoscere, in nessun caso, diritti a rifusione di danni di qualsiasi specie. Eventuali interventi correttivi, sostituzioni e riparazioni effettuate da terzi per disposizioni del cliente dovranno essere previamente autorizzati da Castel. Castel si riserva il diritto di apportare variazioni o modifiche ai propri prodotti senza preavviso ed in qualsiasi momento.

### Resi di prodotti non difettosi

Castel non accetta restituzioni di merci che non siano state da essa esplicitamente autorizzate e che non giungano a Castel a spese del cliente - CPT "Stabilimento Castel Pessano con Bornago (MI)" Incoterms® 2020.

### Prezzi

Si intendono sempre per merce EX WORKS- EXW "Magazzino Castel di Vimercate (MB)" Incoterms® 2020 e possono essere modificati in qualsiasi momento in funzione dei costi.

### Vertenze

Per qualsiasi vertenza è competente il Tribunale di Milano. Si applica la legge italiana, con esclusione della Convenzione ONU di Vienna sulla vendita internazionale.

## APPLICAZIONE DELLA DIRETTIVA 2014/68/UE DEL PARLAMENTO EUROPEO E DEL CONSIGLIO, DEL 15 MAGGIO 2014, IN MATERIA D'ATTREZZATURE A PRESSIONE NEI CONFRONTI DEI PRODOTTI CASTEL PER REFRIGERAZIONE

La Direttiva 2014/68/UE (PED Recast) si applica alla progettazione, fabbricazione e valutazione di conformità delle attrezzature a pressione e degli insiemi con una pressione massima ammissibile "PS" superiore a 0,5 bar con l'esclusione dei casi elencati nell'Articolo 1, Paragrafo 2 della medesima Direttiva.

La rinnovata Direttiva PED Recast abroga la precedente Direttiva 97/23/CE, nello specifico:

- L'articolo 13 della Direttiva PED Recast, relativo alla classificazione delle attrezzature a pressione, è entrato in vigore dal 1° giugno 2015 e abroga l'Articolo 9 della precedente Direttiva PED
- Tutti gli altri articoli della Direttiva PED Recast sono entrati in vigore dal 19 luglio 2016, abrogando tutti gli articoli della precedente direttiva PED. A partire da tale data, negli Stati membri della Comunità Europea, è diventata obbligatoria la commercializzazione unicamente di attrezzature a pressione marcate CE secondo la Direttiva PED Recast.

Ai fini dell'Articolo 2 della Direttiva PED Recast valgono le seguenti definizioni:

- **Attrezzature a pressione:** recipienti, tubazioni, accessori di sicurezza e accessori a pressione.
- **Recipiente:** un alloggiamento progettato e costruito per contenere fluidi in pressione.
- **Tubazioni:** i componenti di una condotta destinati al trasporto di fluidi, allorché essi sono collegati al fine di essere inseriti in un sistema a pressione.
- **Accessori di sicurezza:** i dispositivi destinati alla protezione degli apparecchi a pressione contro il superamento dei limiti ammissibili.
- **Accessori a pressione:** dispositivi aventi funzione di servizio e i cui alloggiamenti sono sottoposti a pressione; ad esempio: valvole solenoidi, rubinetti in genere, indicatori.
- **Insiemi:** varie attrezzature a pressione assiemate da un costruttore per costituire un tutto integrato e funzionante.
- **Pressione massima ammissibile (PS):** la pressione massima per la quale l'attrezzatura è progettata, specificata dal costruttore.
- **Temperatura minima / massima ammissibile (TS):** le temperature minima / massima per le quali l'attrezzatura è progettata, specificate dal costruttore.
- **Volume (V):** il volume interno di una camera compreso il volume dei raccordi alla prima connessione ed escluso il volume degli elementi interni permanenti.
- **Dimensione nominale (DN):** la designazione numerica della dimensione che è comune a tutti i componenti di un sistema di tubazioni
- **Fluidi:** i gas, i liquidi e i vapori allo stato puro e le loro miscele.

Nell'Articolo 4 e nel successivo Allegato II della Direttiva PED Recast le attrezzature a pressione sono classificate in categorie di rischio crescente dalla I alla IV in funzione di:

- Stato del fluido contenuto
- Classe di pericolosità del fluido contenuto
- Tipo di attrezzatura
- Dimensioni e potenziale energetico; V, DN, PS, PS x V, PS x DN

e devono soddisfare i Requisiti Essenziali di Sicurezza stabiliti nell'Allegato I della Direttiva PED Recast.

Le attrezzature aventi caratteristiche inferiori o pari ai limiti fissati ai punti 1.a, 1.b e 1.c e al punto 2 dell'Articolo 4 della Direttiva PED Recast non devono soddisfare i Requisiti Essenziali di Sicurezza stabiliti nell'Allegato I, ma devono essere progettati e fabbricati secondo una corretta prassi costruttiva in uso in uno degli Stati membri che assicuri la sicurezza di utilizzazione; tali attrezzature non devono recare la marcatura CE (Articolo 4, Paragrafo 3).

Nell'Articolo 13 della Direttiva Recast i fluidi sono classificati, in base alla loro pericolosità, in due gruppi:

- **Gruppo 1** che comprende sostanze e miscele, così come definite all'articolo 2, punti 7 e 8, del regolamento CE n. 1272/2008, classificate come pericolose a norma delle classi di pericolo fisico e per la salute di cui all'allegato I, parti 2 e 3 di tale regolamento. Al punto 1.a dell'Articolo 13 sono elencate 18 classi di fluidi pericolosi (esplosivi, infiammabili, comburenti, tossici).
  - **Gruppo 2** che comprende sostanze e miscele non elencate al punto 1.a
- I prodotti della serie CASTEL POLYHEDRA sono adatti all'impiego con fluidi refrigeranti appartenenti ai Gruppi 1 e 2, classificati A1, A2L e A3 nell'Annex E della norma EN 378-1:2016.**

**I prodotti della serie CASTEL CLASSIC sono adatti all'impiego con fluidi refrigeranti appartenenti al Gruppo 2, classificati A1 nell'Annex E della norma EN 378-1:2016.**

**I prodotti della serie CASTEL GOGREEN sono adatti all'impiego unicamente con fluido refrigerante R744, appartenente al Gruppo 2 e classificato A1 nell'Annex E della norma EN 378-1:2016.**

## APPLICAZIONE DELLA DIRETTIVA 2011/65/UE DEL PARLAMENTO EUROPEO E DEL CONSIGLIO, DELL'8 LUGLIO 2011, SULLA RESTRIZIONE DELL'USO DI DETERMINATE SOSTANZE PERICOLOSE NELLE APPARECCHIATURE ELETTRICHE ED ELETTRONICHE NEI CONFRONTI DEI PRODOTTI CASTEL PER REFRIGERAZIONE

La Direttiva 2011/65/UE, meglio conosciuta come Direttiva RoHS 2 o RoHS-Recast (Restriction of Hazardous Substances), mira a proibire o limitare l'uso di determinate sostanze pericolose nelle apparecchiature elettriche ed elettroniche e al recupero e allo smaltimento ecologicamente corretto dei rifiuti d'apparecchiature elettriche ed elettroniche. La Direttiva 2011/65/UE, e successive modifiche apportate dalla Direttiva 2015/863/UE, sostituiscono la precedente Direttiva 2002/95/CE (RoHS) che è stata abrogata con effetto dal 3 gennaio 2013.

Le disposizioni della Direttiva RoHS 2 si applicano alle AEE (Apparecchiature Elettriche ed Elettroniche) che rientrano nelle Categorie 1, 2, 3, 4, 5, 6, 7, 10, 11 elencate nell'Allegato 1 della Direttiva medesima.

Le apparecchiature appartenenti alle categorie 1-**"Grandi elettrodomestici"**

e 10-**"Distributori automatici"** sono dettagliate nell'Allegato 2 della Direttiva 2012/19/UE, RAEE-Recast, (rifiuti di apparecchiature elettriche ed elettroniche) che sostituisce la precedente Direttiva 2002/96/CE, abrogata dal 15 febbraio 2014. Negli elenchi dell'Allegato 2 sono presenti fra l'altro:

- Grandi apparecchi di refrigerazione
- Frigoriferi
- Congelatori
- Altri grandi elettrodomestici per la refrigerazione, la conservazione e il deposito degli alimenti
- Apparecchi per il condizionamento
- Altre apparecchiature per la ventilazione, l'estrazione dell'aria e il condizionamento
- Distributori di bevande calde, fredde, bottiglie e lattine

L'articolo 4 della Direttiva RoHS 2 prevede che le AEE immesse sul mercato, compresi i cavi e i pezzi di ricambio destinati alla loro riparazione, al loro riutilizzo, all'aggiornamento delle loro funzionalità al potenziamento delle loro capacità, non contengano le sostanze elencate nell'Allegato 2, così come modificato nella Direttiva 2015/863/UE, cioè:

- Piombo - (0,1%)
- Mercurio - (0,1%)
- Cadmio - (0,01%)
- Cromo esavalente - (0,1%)
- Bifenili polibromurati (PBB) - (0,1%)
- Etere di difenile polibromurato (PBDE) - (0,1%)
- Ftalato di bis (2-etilesile) (DEHP) - (0,1%)
- Benzilbutilftalato (BBP) - (0,1%)
- Dibutilftalato (DBP) - (0,1%)
- Diisobutilftalato (DIBP) - (0,1%)

L'Allegato 3 prevede diverse esenzioni sulle restrizioni all'uso indicate nell'articolo 4 e Allegato 2. Fra le varie esenzioni previste sono di particolare interesse per il settore della refrigerazione/condizionamento le seguenti:

- Piombo come elemento di lega nell'acciaio contenente fino allo 0,35% di piombo in peso (esenzione 6a dell'Allegato 3, prorogata fino al 21 luglio 2021 dalla Direttiva UE 2018/739 del 1 marzo 2018)
- Piombo come elemento di lega nell'alluminio contenente fino allo 0,4% di piombo in peso (esenzione 6b dell'Allegato 3, prorogata fino al 21 luglio 2021 dalla Direttiva UE 2018/740 del 1 marzo 2018)
- Piombo come elemento di lega nelle leghe di rame contenenti fino al 4% di piombo in peso (esenzione 6c dell'Allegato 3, prorogata fino al 21 luglio 2021 dalla Direttiva UE 2018/741 del 1 marzo 2018)

La ditta Castel ha avviato da prima del 2005, anno di recepimento delle Direttive 2002/95/CE e 2002/96/CE da parte dello Stato Italiano, un'accurata indagine, congiuntamente con i propri fornitori, con lo scopo di individuare la presenza o meno delle sopradette sostanze pericolose sia nei propri prodotti sia nei propri processi produttivi e progressivamente eliminarle.

Al termine di quest'ampia analisi iniziale e di un continuo monitoraggio dei prodotti e dei processi, la ditta Castel è in grado di dichiarare che tutti i prodotti che fornisce ai propri clienti sono conformi alle restrizioni dell'uso di determinate sostanze pericolose, definite nella Direttiva 2001/65/UE.

Nello specifico i prodotti della ditta Castel:

1. Non contengono mercurio, cadmio, cromo esavalente, (PBB), (PBDE), (DEHP), (BBP), (DBP), (DIBP)
2. Contengono piombo come elemento di lega nell'acciaio, nell'alluminio e nelle leghe di rame entro i limiti di accettabilità previsti dall'Allegato 3 della Direttiva RoHS 2 e successivi aggiornamenti.

La ditta Castel dichiara altresì che i tutti i prodotti forniti ai propri clienti, in quanto **componenti/ricambi** utilizzati in AEE non devono:

- essere marchiati CE come richiesto nell'articolo 15 della Direttiva 2011/65/UE
- essere accompagnati da una Dichiarazione di Conformità redatta secondo l'Allegato 6 della medesima Direttiva.

come specificato nel Cap. 7 - par. Q7.3 e nel Cap. 8 - par. Q8.5 della Guida RoHS 2 FAQ pubblicata il 12/12/2012 dalla Commissione Europea

## APPLICAZIONE DEL REGOLAMENTO 1907/2006/CE DEL PARLAMENTO EUROPEO E DEL CONSIGLIO, DEL 18 DICEMBRE 2006, CONCERNENTE LA REGISTRAZIONE, LA VALUTAZIONE, L'AUTORIZZAZIONE E LA RESTRIZIONE DELLE SOSTANZE CHIMICHE (REACH) NEI CONFRONTI DEI PRODOTTI CASTEL PER REFRIGERAZIONE

Il Regolamento europeo 1907/2006/CE concernente la registrazione, la valutazione, l'autorizzazione e la restrizione delle sostanze chimiche, meglio noto con l'acronimo di REACH (Registration, Evaluation, Authorisation of Chemicals) è stato pubblicato sulla GUCE L136 del 29 maggio 2007 ed è

entrato in vigore in tutta l'Unione Europea il 1° Giugno 2007. Tale Regolamento richiede la pre-registrazione e la registrazione delle sostanze chimiche prodotte o importate in Europa presso l'Agenzia europea per le sostanze chimiche (European Chemicals Agency - ECHA).

La ditta Castel si è prontamente attivata per approfondire i contenuti e le finalità della nuova legislazione con lo scopo di definire i ruoli che essa assume nella catena d'approvvigionamento e gli eventuali obblighi a cui deve adempiere, in conformità al Regolamento REACH.

La ditta Castel non è un "fabbricante" o un "importatore" di sostanze e quindi non deve ottemperare agli obblighi di pre-registrazione e/o registrazione.

La ditta Castel non è un "fabbricante" o un "importatore" di preparati e quindi non deve fornire ai clienti informazioni sulla registrazione delle sostanze contenute in essi né informazioni sulla sicurezza.

La ditta Castel non è un "fabbricante" o un "importatore" di articoli che rilasciano sostanze in condizioni d'uso normali o ragionevolmente prevedibili (Art. 7.1 del REACH) e quindi non deve ottemperare agli obblighi di pre-registrazione e/o registrazione di tali sostanze.

La ditta Castel, nei confronti dei propri fornitori, è un "utilizzatore a valle" di sostanze, preparati e articoli utilizzati nei propri processi produttivi e nei propri prodotti. La ditta ha avviato da tempo presso tutti i suoi fornitori di sostanze/preparati e articoli una raccolta d'informazioni per verificare che:

- siano a conoscenza dei contenuti e finalità del Regolamento REACH
- si siano attivati per adempiere agli obblighi di loro competenza previsti dal suddetto Regolamento
- ci assicurino la continuità delle loro forniture per il futuro

La ditta Castel, nei confronti dei suoi clienti, è un "fabbricante" di articoli e in tale ruolo è costantemente impegnata a verificare che nei suoi prodotti:

- non siano utilizzate in modo non conforme alla restrizione le sostanze soggette a restrizioni elencate nell'Allegato XVII, secondo quanto previsto dall'Art. 67. del REACH

non siano presenti in concentrazioni superiori allo 0,1% peso/peso. (il limite dello 0,1% è relativo al peso totale dell'articolo) le sostanze estremamente problematiche, meglio note con l'acronimo di SVHC (Substance of Very High Concern) elencate nella Candidate List e nell'Authorisation List dell'Allegato XIV e contemporaneamente soddisfatte tutte le condizioni elencate nell'Art. 7.2 del REACH. Qualora si verifici questa eventualità la ditta Castel si impegna a comunicarlo tempestivamente ai propri clienti, fornendo informazioni sufficienti per l'uso in sicurezza, secondo quanto previsto dall'Art. 33 del REACH. Per avere ulteriori informazioni circa la SVHC Candidate List aggiornata, suggeriamo ai nostri clienti di visitare il sito [http://echa.europa.eu/chem\\_data/candidate\\_list\\_table\\_en.asp](http://echa.europa.eu/chem_data/candidate_list_table_en.asp) dell'Agenzia Europea ECHA.

## APPLICAZIONE DEL REGOLAMENTO UE N° 517/2014 DEL PARLAMENTO EUROPEO E DEL CONSIGLIO, DEL 16 APRILE 2014, SUI GAS FLUORURATI AD EFFETTO SERRA (F-GAS) NEI CONFRONTI DEI PRODOTTI CASTEL PER REFRIGERAZIONE

Il Regolamento europeo UE No 517/2014 sui gas fluorurati ad effetto serra, meglio noto come Regolamento F-Gas, è stato pubblicato sulla GUCE L150 del 20 maggio 2014 ed è entrato in vigore in tutta l'Unione Europea il 1° gennaio 2015, abrogando il precedente Regolamento CE No 842/2006.

Il nuovo regolamento si articola su tre argomenti principali trattati nei seguenti capitoli:

- Capo II: Contenimento
- Capo III: Immissione in commercio e controllo dell'uso
- Capo IV: Riduzione della quantità di idrofluorocarburi immessa in commercio.

### Contenimento

L'articolo 4 prevede che gli operatori di apparecchiature contenenti gas fluorurati ad effetto serra in quantità pari o superiore a 5 tonnellate di CO<sub>2</sub> equivalente devono assicurare controlli per verificare eventuali perdite. Le apparecchiature del settore condizionamento e refrigerazione da controllare sono: apparecchiature fisse di refrigerazione, apparecchiature fisse di condizionamento dell'aria, pompe di calore fisse, celle frigorifere di autocarri e rimorchi. Sono escluse dai controlli le apparecchiature ermeticamente sigillate contenenti F-Gas in quantità inferiore a 10 tonnellate equivalenti di CO<sub>2</sub>, purché etichettate come ermeticamente sigillate.

### Immissione in commercio e controllo dell'uso

Restrizioni all'immissione in commercio: l'articolo 11 prevede che, a decorrere dalle date indicate, sia vietata l'immissione in commercio dei prodotti e delle apparecchiature elencati nell'Allegato III. Le apparecchiature del settore condizionamento e refrigerazione sottoposte a tale divieto sono:

Descrizione prodotto	Data divieto
Frigoriferi e congelatori per uso domestico che contengono HFC con GWP $\geq$ 150	01/01/2015
Frigoriferi e congelatori per uso commerciale (apparecchiature ermeticamente sigillate) che contengono HFC con GWP $\geq$ 2500	01/01/2020
Frigoriferi e congelatori per uso commerciale (apparecchiature ermeticamente sigillate) che contengono HFC con GWP $\geq$ 150	01/01/2022
Apparecchiature fisse di refrigerazione contenenti HFC con GWP $\geq$ 2500, eccetto apparecchiature progettate per funzionare a T < -50 °C	01/01/2020
Sistemi di refrigerazione centralizzati multipack per uso commerciale con potenzialità nominale $\geq$ 40 kW che contengono HFC con GWP $\geq$ 150, eccetto circuiti primari di impianti a cascata dove è permesso l'utilizzo di HFC con GWP < 1500. 01/01/2022	
Apparecchiature mobili di climatizzazione (apparecchiature ermeticamente sigillate) che contengono HFC con GWP $\geq$ 150	01/01/2020
Sistemi di condizionamento monosplit contenenti meno di 3 Kg di HFC con GWP $\geq$ 750	01/01/2025

**Controllo dell'uso:** l'articolo 13 prevede che a decorrere dal 1 gennaio 2020 è vietato l'uso di HFC con GWP  $\geq$  2500 per l'assistenza e la manutenzione delle apparecchiature di refrigerazione con carica di refrigerante  $\geq$  40 tonnellate di CO<sub>2</sub> equivalente. La proibizione non si applica per apparecchiature progettate per funzionare a T < -50 °C. Il divieto è posticipato al 1 gennaio 2030 per HFC rigenerati con GWP  $\geq$  2500, etichettati in conformità all'articolo 12, e per HFC riciclati con GWP  $\geq$  2500, scaricati dalla stessa apparecchiatura su cui si fa manutenzione.

#### Riduzione della quantità di idrofluorocarburi immessa in commercio

L'articolo 15 prevede che la quantità di HFC che i produttori e gli importatori possono immettere ogni anno in commercio nell'Unione Europea non deve eccedere la quantità massima indicata nell'Allegato V. Facendo 100% la quantità massima permessa nel 2015, l'Allegato V prevede una riduzione progressiva della quantità massima commerciabile fino ad arrivare al 21% nel 2030. Dal 1 gennaio 2017 anche le apparecchiature di refrigerazione, condizionamento e pompe di calore precaricate con HFC possono essere messe in commercio unicamente se rientrano nelle quantità massime previste dall'Allegato V.

L'articolo 16 prevede che all'interno di questa quantità massima definita per anno la Commissione Europea assegni ai produttori in regola con il regolamento delle quote di immissione sul mercato di HFC.

Riteniamo che l'applicazione del Regolamento F-Gas porterà in breve tempo a grandi cambiamenti nei vari settori della refrigerazione e, seppure in minor misura, anche nel condizionamento dell'aria. L'impiego di due refrigeranti considerati primari nel settore della refrigerazione, l'R404A (GWP=3922 secondo AR4) e l'R507 (GWP=3985 secondo AR4) è destinato a ridursi drasticamente nel giro di pochi anni fino a sparire completamente. Lo stesso utilizzo dell'R134a (GWP=1430 secondo AR4) è destinato a ridursi considerando i cambiamenti in atto su refrigerazione domestica e condizionamento automotive. Anche l'utilizzo dei due refrigeranti tradizionalmente utilizzati in condizionamento, l'R407C (GWP=1774 secondo AR4) e l'R410A (GWP=2088 secondo AR4) è destinato a ridimensionarsi considerando le apparecchiature di climatizzazione citate nell'Allegato III del regolamento.

La ditta Castel si è prontamente attivata per approfondire i contenuti e le finalità della nuova legislazione con lo scopo di verificare la compatibilità dei propri prodotti con i nuovi fluidi refrigeranti che le maggiori case produttrici propongono come alternativa ai tradizionali HFC destinati alla proibizione.

Negli ultimi due anni la Castel ha già presentato due linee di prodotto specifiche per utilizzo con fluidi refrigeranti naturali: una linea di prodotto per CO<sub>2</sub>, con differenti pressioni di utilizzo, una linea di prodotto per idrocarburi (R290, R600, R600a)

Contemporaneamente dall'anno 2015 in poi la Castel ha condotto una campagna di prove per verificare/validare la compatibilità:

- dei propri prodotti standard, normalmente utilizzati con refrigeranti HFC tradizionali
- dei nuovi prodotti serie POLYHEDRA, da immettere sul mercato con la maggior parte dei nuovi refrigeranti, alternativi ai tradizionali, proposti dalle maggiori case produttrici.

## ATTACCHI DEI PRODOTTI CASTEL

I prodotti Castel possono essere forniti con differenti tipi di attacchi. In modo particolare i prodotti Castel sono costruiti o con attacchi filettati o con attacchi

a saldare.

In Tabella 1 è riportata l'equivalenza tra i codici Castel e le dimensioni in pollici. Questi codici sono normalmente impiegati nel mercato internazionale. In Tabella 2 è riportata l'equivalenza tra i codici Castel e le dimensioni in millimetri.

## DESCRIZIONE DEGLI ATTACCHI ATTUALMENTE UTILIZZATI PER I PRODOTTI CASTEL

### 1) ATTACCHI FILETTATI

Possono essere di tre tipi differenti:

#### FLARE

Attacco filettato (secondo SAE J513-92; ASME B1.1-89) per collegamento con tubo di rame con estremità opportunamente svasata "cartellatura" a mezzo di un adatto bocchettone (vedi Tabella 3).

#### NPT

Attacco filettato con filettatura conica (secondo ASME B1.20.1-92) per il collegamento di raccordi, rubinetti, valvole di sicurezza a serbatoi o tubazioni in acciaio.

#### FPT

Attacco filettato femmina con filettatura GAS cilindrica (secondo ISO 228/1) usato in idraulica per il collegamento di raccordi o rubinetti a serbatoi o tubazioni in acciaio (vedi tabella 4).

### 2) ATTACCHI A SALDARE.

Possono essere di quattro differenti tipi e sono adatti per tubi con diametro sia in pollici che in millimetri:

#### ODS (oppure ODF)

Attacco a saldare femmina per tubo in rame. La dimensione indicata corrisponde al diametro esterno del tubo in rame a cui effettuare il collegamento.

Esempio: 1/2" ODS attacco a saldare adatto a ricevere al suo interno un tubo di rame con diametro esterno di 1/2".

#### ODM

Attacco a saldare maschio per tubo in rame. La dimensione indicata corrisponde al diametro esterno del tubo in rame a cui effettuare il collegamento.

Esempio: 16 ODM attacco a saldare adatto a collegarsi ad un tubo di rame con diametro esterno da 16 mm mediante un manicotto femmina/femmina M16.

#### IDS

Attacco a saldare maschio per tubo in rame. La dimensione indicata corrisponde al diametro interno del tubo in rame a cui effettuare il collegamento.

Esempio: 10 IDS attacco a saldare adatto a ricevere al suo esterno un tubo in rame con diametro interno di 10 mm.

#### W

Attacco a saldare per tubi in acciaio. La dimensione indicata corrisponde al diametro esterno del tubo in acciaio a cui effettuare il collegamento.

Esempio: 76,1 W attacco a saldare adatto a collegarsi a un tubo in acciaio con diametro esterno di 76,1 mm mediante saldatura elettrica di testa.





## GENERAL SALES CONDITIONS

### Orders

Orders require full acceptance by the customer of Castel conditions of sale listed below and Castel is not bound to the buyer's purchase conditions, without prejudice to the existence in force of special conditions stipulated and signed between Castel and the Customer.

### Shipping

The goods delivery is EX WORKS - EXW "Magazzino Castel di Vimercate (MB)" Incoterms® 2020 for goods shipped in the EU, otherwise FREE CARRIER - FCA "Magazzino Castel di Vimercate (MB)" Incoterms® 2020, for goods shipped outside of the EU.

### Packaging

Packaging is invoiced at cost price and is not accepted for return.

Deliveries: Delivery terms are not binding on Castel: therefore no liability charges or penalties for delivery delays are accepted. Any delays do not give the right to terminate the contract.

### Payments

Late payments give Castel the right to suspend supplies and terminate current contracts.

### Complaints

Generally, only complaints sent to Castel office within ten days of receiving the materials are valid. Any obvious manufacturing defects that are revealed during use and after the expiration of ten days will be considered according to the terms of the "warranty" paragraph. No warranty of good functioning is given unless through a special clause in writing.

### Warranty

All Castel products are guaranteed for a period of 12 months starting from the date of the transport document. The warranty covers all those products or parts thereof that are defective and have manufacturing or other defects within the warranty period. Defects must be reported within the terms established by Italian law. In this case, the customer will have to return the materials together with a detailed description of the defects found at his own expense, subject to recognition of the cost in the event of an ascertained defect. The guarantee is not recognized when the defects of Castel products are due to errors of the customer or third parties such as: incorrect installation, uses contrary to the indications provided by Castel, tampering. For any defects or faults in its products, Castel undertakes to replace them pure and simple without recognizing, in any case, the right to reimbursement of damages of any kind. Any corrective interventions, replacements and repairs carried out by third parties for the customer's instructions must be previously authorized by Castel. Castel reserves the right to make changes or modifications to its products without notice and at any time.

### Returns of non-defective products

Castel does not accept returns of goods that have not been explicitly authorized by us and that do not reach us in Castel at the customer's expense - CPT "Castel Pessano con Bornago (MI) plant" Incoterms® 2020.

### Prices

These are always intended for EX WORKS-EXW "Magazzino Castel di Vimercate (MB)" Incoterms® 2020 goods and can be changed at any time depending on costs.

### Disputes

The Court of Milan is competent for any dispute. Italian law applies, with the exclusion of the UN Vienna Convention on international sales.

## IMPLEMENTATION OF EUROPEAN PARLIAMENT AND EUROPEAN COUNCIL DIRECTIVE 2014/68/EU DATED 15 MAY 2014, CONCERNING PRESSURE EQUIPMENT TO CASTEL REFRIGERATION PRODUCTS

Directive 2014/68/EU (PED Recast) applies to the design, manufacture and conformity assessment of pressure equipment and assemblies with a maximum allowable pressure "PS" greater than 0,5 bar excluding the cases listed in Article 1, Section 2 of the Directive.

The revised PED Recast Directive repeals previous Directive 97/23/EC. More specifically:

- Article 13 of the PED Recast Directive, regarding the classification of pressure equipment, came into force as of 1 June 2015 and repeals Article 9 of the previous PED Directive
- All other articles of the PED Recast Directive are in force as of 19 July 2016, repealing all articles of the previous PED Directive. As of this date, in the Member States of European Community, it is possible to place on the market only pressure equipments CE marked according to PED Recast.

The definitions below shall apply for the purposes of Article 2 of Directive PED Recast:

- **Pressure equipment:** vessels, piping, safety accessories, and pressure accessories
- **Vessel:** a container designed and built to keep fluids under pressure.
- **Piping:** piping components intended for the transport of fluids, when connected together to form a pressure system.
- **Safety accessories:** devices designed to protect pressure equipment

from exceeding the admissible limits.

- **Pressure accessories:** devices with an operational function and including pressure-bearing containers. For example: solenoid valves, valves, indicators.
- **Assemblies:** several pieces of pressure equipment assembled by a manufacturer to constitute an integrated and functional set.
- **Maximum admissible pressure (PS):** the maximum pressure the equipment is designed for, as specified by the manufacturer.
- **Maximum/minimum allowable temperature (TS):** the maximum/minimum temperatures the equipment is designed for, as specified by the manufacturer.
- **Volume (V):** the internal volume of a chamber, including the volume of nozzles to the first connection or weld and excluding the volume of permanent inner parts.
- **Nominal size (DN):** numerical designation of size, which is common to all components in a piping system.
- **Fluids:** gases, liquids and vapours in pure form as well as mixes thereof. Pressure equipments referred to in Article 4 and subsequent Annex II to Directive PED Recast are classified by categories according to ascending level of hazard, on the basis of:
  - State of the fluid
  - Hazard classification of the fluid
  - Type of equipment
  - Dimensions and energetic potential; V, DN, PS, PS x V, PS x DN
 and must comply with the Essential Safety Requirements as set out in Annex I of PED Recast Directive.

Pressure equipment whose characteristics are below or equal to the limits in Article 4, points 1.a, 1.b and 1.c and section 2 of Directive PED Recast must not comply with the Essential Safety Requirements as set out in Annex I, but must be designed and manufactured in accordance with the sound engineering practice in a Member State in order to guarantee safe use; these products needn't bear EC marking (Article 4, Paragraph 3).

In Article 13 of Directive PED Recast, fluids are classified, according to level of their hazard, in two groups:

- **Group 1** includes substances and mixtures, as defined in points 7 and 8 of Article 2 of EC Regulation No 1272/2008, that are classified as hazardous in accordance with physical or health hazard classes as laid down in Parts 2 and 3 of Annex I to that Regulation. A list of 18 classes of hazardous fluids is included in point 1.a of Article 13 (explosive, flammable, oxidizing, toxic).

- **Group 2** includes substances and mixtures not listed on point 1.a

**The products of the CASTEL POLYHEDRA series are suitable for using with refrigerant fluids proper to the Groups 1 and 2, classified A1, A2L and A3 in Annex E of standard EN 378-1:2016.**

**The products of the CASTEL CLASSIC series are suitable for using with refrigerant fluids proper to the Group 2, classified A1 in Annex E of standard EN 378-1:2016.**

**The products of the CASTEL GOGREEN series are suitable for using only with refrigerant fluid R744, proper to the Group 2 and classified A1 in Annex E of standard EN 378-1:2016.**

## APPLICATION OF DIRECTIVE 2011/65/UE OF THE EUROPEAN PARLIAMENT AND OF THE COUNCIL, OF 8 JULY 2011, ON THE RESTRICTION OF THE USE OF CERTAIN HAZARDOUS SUBSTANCES IN ELECTRICAL AND ELECTRONIC EQUIPMENT TOWARDS CASTEL REFRIGERATION PRODUCTS

The purpose of Directive 2011/65/EU, the so called RoHS 2 or RoHS Recast Directive, is to prevent or restrict the use of hazardous substances in electrical and electronic equipment and to contribute to the environmentally sound recovery and disposal of waste electrical and electronic equipment.

Directive 2011/65/EU, and subsequent amendments made by Directive 2015/863/EU, replaces the previous Directive 2002/95/EC that is repealed with the effect from 3 January 2013.

RoHS 2 Directive shall apply to EEE (Electrical and Electronic Equipment) falling under the categories 1, 2, 3, 4, 5, 6, 7, 10, 11 set out in Annex 1 of the same Directive.

The equipment proper to the first category - "**Large household appliances**", and to the 10th category - "**Automatic dispensers**", are set out in Annex 2 of Directive 2012/19/EU, WEEE-Recast Directive (Waste electrical and electronic equipment) that replaces the previous Directive 2002/96/EC, repealed from 15 February 2014. The list of Annex 2 shows these products:

- Large cooling appliance
- Refrigerators
- Freezers
- Other large appliances used for refrigeration, conservation and storage of food
- Air conditioner appliances
- Other fanning, exhaust ventilation and conditioning equipment
- Automatic dispenser for hot or cold bottles and cans

Article 4 of RoHS 2 Directive establishes that EEE placed on the market, including cable and spare parts for its repair, its reuse, updating of its functionalities or upgrading of its capacities, do not contain the following substances listed in Annex 2, as amended by Directive 2015/863/EU:

- Lead – (0,1%)
- Mercury – (0,1%)
- Cadmium – (0,001%)
- Hexavalent chromium – (0,1%)
- Polybrominated biphenyls (PBB) – (0,1%)
- Polybrominated diphenyl ethers (PBDE) – (0,1%)
- Bis(2-ethylhexyl) phthalate (DEHP) (0,1 %)
- Butyl benzyl phthalate (BBP) (0,1 %)
- Dibutyl phthalate (DBP) (0,1 %)
- Diisobutyl phthalate (DIBP) (0,1 %)

Annex 3 provides several exemptions on the restrictions on use indicated in Article 4 and Annex 2. Among the various exemptions provided, the following are of particular interest for the refrigeration / air conditioning sector:

- Lead as an alloying element in steel containing up to 0.35% lead by weight (exemption 6a of Annex 3, extended until 21 July 2021 by EU Directive 2018/739 of 1 March 2018)
- Lead as an alloying element in aluminum alloys containing up to 0.4% lead by weight (exemption 6b of Annex 3, extended until 21 July 2021 by EU Directive 2018/740 of 1 March 2018)
- Lead as an alloying element in copper alloys containing up to 4% lead by weight (exemption 6c of Annex 3, extended until 21 July 2021 by EU Directive 2018/741 of 1 March 2018)

For a long time, before year 2005, Castel Company has started a careful inquiry, together with its suppliers, to identify the presence or not of the above-mentioned hazardous substances, either in its own products or in its own production processes, and to remove them progressively.

At the end of this wide examination and continuously monitoring its products and processes, Castel Company may declare that all the products supplied to its customers are compliant to the Restriction on Hazardous Substances, as defined in the Directive 2011/65/EU.

Specially Castel products:

1. Do not contain mercury, cadmium, hexavalent chromium, (PBB), (PBDE), (DEHP), (BBP), (DBP), (DIBP)
2. Contain lead as an alloying element in steel, aluminium and copper alloys within the accepted limits according to the Annex 3 of RoHS 2 Directive and subsequent amendments.

Castel also declares that all the products supplied to its customers, since **components / spare parts** used in EEE do not have:

- to be CE marked, as requested in article 15 of Directive 2011/65/EU
- a Declaration of Conformity, written according to Annex 6 of the same directive.

as specified in Chap. 7 – par. Q7.3 and in Chap. 8 par. Q8.5 of the RoHS 2 FAQ Guidance published by European Commission, dated 12/12/2012.

## APPLICATION OF REGULATION 1907/2006/EC OF THE EUROPEAN PARLIAMENT AND OF THE COUNCIL, OF 18 DECEMBER 2006, ON THE REGISTRATION, EVALUATION, AUTHORISATION AND RESTRICTION OF CHEMICALS (REACH) TOWARDS CASTEL REFRIGERATION PRODUCTS

The European Regulation 1907/2006/EC concerning the Registration, Evaluation, Authorization and Restrictions of Chemicals, the so called REACH Regulation, was published on GUCE L136 dated 29 May 2007 and came into force in the European Union on the 1st June 2007. This Regulation requires to pre-register and register chemical substances produced or imported into Europe at the European Agency for Chemicals (ECHA).

Castel investigates for a long time about the contents and the aims of this new law. The purpose of our company is to define its rules in the supply chain and the possible obligations we have to fulfil to, according to the REACH Regulation.

Castel is not a “manufacturer” or an “importer” of substances and so the company has not the obligation to pre-register and/or register.

Castel is not a “manufacturer” or an “importer” of preparations and so the company has not to give to its customers either information about registrations of the contained substances or information about safety.

Castel is not a “manufacturer” or an “importer” of articles that have substances intended to be realised during normal and reasonable foreseeable conditions of use (Art. 7.1 of REACH) and so the company has not the obligation to pre-register and/or register these substances.

For its suppliers, Castel is a “downstream users” of substances, preparations and articles, used in its own manufacturing processes and in its own products. For a long time our Company has started, together with its suppliers of substances/preparations and articles, a careful inquiry to verify that:

- They well know the contents and the aims of REACH Regulation
- They are working to fulfil the obligations pertaining to them, foreseen by the Regulation
- They guarantee us smooth continuity of their supplies also in the future

For its customers, Castel is a “manufacturer” of articles and in this rule our company is constantly engaged to verify that in its products:

- The restricted substances listed in Annex XVII are not used in a manner not conform to restrictions, in compliance with to Art. 67 of REACH
- The SVHC, Substances of Very High Concern, listed in the Candidate List and in the Authorisation List of Annex XIV; are not present in the articles we supply you in more than 0,1% mass/mass. (the 0,1% threshold relates to the total weight of the articles) and simultaneously satisfied all the conditions listed in Art. 7.2 of REACH. If this case happens our company binds itself to communicate it in time to its own customers, ensuring sufficient information to safety use, according to Art. 33 of REACH. To obtain further information about the new SVHC Candidate List, please visit the following web site [http://echa.europa.eu/chem\\_data/candidate\\_list\\_table\\_en.asp](http://echa.europa.eu/chem_data/candidate_list_table_en.asp) of ECHA European Agency.

## IMPLEMENTATION OF EUROPEAN PARLIAMENT AND EUROPEAN COUNCIL DIRECTIVE EU N° 517/2014 DATED 16 APRIL 2014 ON FLUORINATED GREENHOUSE GASES (F-GAS) TO CASTEL REFRIGERATION PRODUCTS

European Regulation EU No. 517/2014 on fluorinated greenhouse gases, the so called F-Gas Regulation, was published in the Official Gazette of the Economic Community L150 dated 20 May 2014 and became into force in the European Union on the 1st January 2015, repealing previous Regulation EC No 842/2006.

The new regulation is divided into three main topics and includes the following chapters.

- Chapter II: Containment
- Chapter III: Release onto the market and control of use
- Chapter IV: Reduction of the quantity of hydrofluorocarbons released onto the market

### Containment

Article 4 states that the operators of equipments that contain fluorinated greenhouse gases in quantities not smaller than 5 tonnes of CO<sub>2</sub> equivalent must assure that the equipment is checked for leaks. The conditioning and refrigerating equipment to be checked is as follows: stationary refrigeration equipment, stationary air-conditioning equipment, stationary heat pumps, refrigeration units of trucks and trailers. Hermetically sealed equipment that contains fluorinated greenhouse gases in quantities smaller than 10 tonnes of CO<sub>2</sub> equivalent, shall not be subject to leak checks, provided that they are labelled as hermetically sealed.

### Release onto the market and control of use

**Restriction on the release onto the market:** Article 11 states that the release onto the market of products and equipment listed in Annex III, shall be prohibited from the date specified here below. Refrigeration and air-conditioning equipment subject to the prohibition are:

Product Description	Date of prohibition
Domestic refrigerators and freezers that contain HFCs with GWP ≥ 150	01/01/2015
Refrigerators and freezers for commercial use (hermetically sealed equipment) that contain HFCs with GWP ≥ 2500	01/01/2020
Refrigerators and freezers for commercial use (hermetically sealed equipment) that contain HFCs with GWP ≥ 150	01/01/2022
Stationary refrigeration equipment that contains HFCs with GWP ≥ 2500, except equipment designed to work at T < -50 °C	01/01/2020
Multipack centralised refrigeration systems for commercial use with rated capacity ≥ 40 kW that contain HFCs with ≥ 150, except primary circuit of cascade systems where HFCs with GWP < 1500 may be used.	01/01/2022
Movable air-conditioning equipment (hermetically sealed equipment) that contain HFCs with GWP ≥ 150	01/01/2020

Single split air-conditioning systems containing less than 3 Kg of HFCs with GWP  $\geq$  750

01/01/2025

**Control of use:** Article 13 states that the use of HFCs with GWP  $\geq$  2500 to service or maintain refrigeration equipment with a refrigerant load  $\geq$  40 tonnes of CO<sub>2</sub> equivalent, shall be prohibited from 1 January 2020. This prohibition shall not apply to equipments designed to work at T < -50 °C. The ban is postponed to 1 January 2030 for regenerated HCFs with GWP  $\geq$  2500, labelled in accordance with Article 12, and for recycled HCFs with GWP  $\geq$  2500, drained from the same equipment under maintenance.

#### Reduction of the quantity of hydrofluorocarbons released on the market

Article 15 provides that the quantity of HFCs that manufacturers and importers are entitled to release onto the market in the European Union each year must not exceed the maximum quantity indicated in Annex V. If 100% is the maximum quantity admitted in 2015, Annex V foresees a gradual reduction of the maximum marketable quantity up to 21% in 2030. From 1 January 2017 also refrigeration, air-conditioning and heat pump equipment preloaded with HFCs can only be released onto the market if they fall into the maximum quantities provided for by Annex V. Article 16 provides that the European Commission assigns every year to the manufacturers that comply with the Regulation, HFCs quotas that can be released onto the market, within the maximum quantity defined for that year.

We believe that the F-Gas Regulation will soon lead to great changes in refrigeration and, to a lesser extent, also in air-conditioning. The use of two refrigerants that are considered as primary in the refrigeration industry, R404A (GWP = 3922 according to AR4) and R507 (GWP = 3985 according to AR4), is expected to fall sharply within a few years until it disappears completely. The use of R134a (GWP = 1430 according to AR4) is also set to drop because of the current changes in domestic refrigeration and automotive air-conditioning. The use of the two traditionally refrigerants for air conditioning, R407C (GWP = 1774 according to AR4) and R410A (GWP = 2088 according to AR4) is expected to shrink considering the equipments mentioned in Annex III of the Regulation.

Castel took immediate steps to understand the contents and purposes of the new legislation in order to check the compatibility of its products with the new fluid refrigerants that are offered by most manufacturers as alternatives to traditional HFCs that are going to be banned.

In the last two years Castle has already presented two specific product lines for use with natural refrigerants: a product line for CO<sub>2</sub>, with different operating pressures, a product line for hydrocarbons (R290, R600, R600a) At the same time from the year 2015 onwards, Castel conducted a test campaign to verify / validate the compatibility:

- of its standard products, normally used with traditional HFC refrigerants
- of the new POLYHEDRA series products, to be placed on the market with most of the new refrigerants, alternative to the traditional ones, proposed by the major manufacturers.

## CONNECTIONS OF CASTEL PRODUCTS

Castel products can be supplied with different connections. In particular Castel products are produced either with threaded connections or solder connections.

Table 1 shows the equivalence between Castel codes and dimensions in inches. These codes are commonly used in the international market.

Table 2 shows the equivalence between Castel codes and dimensions in millimetres.

## DESCRIPTION OF CONNECTIONS THAT ARE CURRENTLY USED FOR CASTEL PRODUCTS

### 1) THREADED CONNECTIONS

They can be of three different types:

#### FLARE

Straight threaded connection (according to SAE J513-92; ASME B1.1-89) for junction to a copper pipe with a suitable flared end, using a right nut (see Table 3).

#### NPT

Taper threaded connection (according to ASME B1.20.1-92) to joint fittings, valves, safety valves to vessel or steel pipes.

#### FPT

Straight female threaded connection (according to UNI ISO 228/1) used in the hydraulic system to joint fittings or valves to vessel or steel pipes (see table 4).

### 2) SOLDER CONNECTIONS

They can be of four different types and can fit pipes with diameter both in inches and in millimetres:

#### ODS (or ODF)

Female solder connection for copper tubes. The indicated size corresponds to the outer diameter of the copper tube which to joint.

F.e.: 1/2" ODS solder connection suitable to receive inside a copper pipe

with a 1/2" outer diameter

#### ODM

Male solder connection for copper tubes. The indicated size corresponds to the outer diameter of the copper tube which to joint.

F.e.: 16 ODM solder connection suitable to joint a copper pipe with a 16 mm outer diameter, by means of an M16 female/female copper sleeve.

#### IDS

Male solder connection for copper tube. The indicated size corresponds to the inner diameter of the copper tube which to joint.

F.e.: 10 IDS solder connection suitable to receive outside a copper pipe with an 10 mm inner diameter)

#### W

Solder connection for steel pipes. The indicated size corresponds to the external diameter of the steel pipe which to joint.

F.e.: 76,1 W solder connection suitable to connect a steel pipe with a 76,1 mm external diameter, by means of butt welding.





## CONDITIONS GÉNÉRALES DE VENTE

### Commandes

Toute commande suppose l'acceptation, par le client, de l'intégralité des conditions de vente Castel énumérées ci-dessous et n'engage pas Castel aux conditions d'achat de l'acheteur, sans préjudice de l'existence en vigueur de conditions particulières stipulées et signées entre Castel et le client.

### Expéditions

La livraison des marchandises est EX WORKS - EXW « Magasin Castel di Vimercate (MB) » Incoterms® 2020, pour les marchandises livrées sur le territoire de la Communauté Européenne et FREE CARRIER - FCA « Magasin Castel di Vimercate (MB) » Incoterms® 2020, pour les marchandises livrées hors du territoire douanier de la Communauté européenne.

### Emballages

L'emballage est facturé au prix de revient et aucun retour n'est accepté.

### Livraisons

Les conditions de livraison ne sont pas contraignantes pour Castel : aucune responsabilité ni pénalité pour retard de livraison n'est donc acceptée. Un éventuel retard ne donne pas le droit de résilier le contrat.

### Paiements

Les retards de paiement donnent à Castel le droit de suspendre les fournitures et de résilier les contrats existants.

### Réclamations

En général, seules les réclamations envoyées à notre bureau dans les dix jours suivant la réception des matériaux sont valables. Tout éventuel défaut de fabrication et similaire qui serait révélé lors de l'utilisation et après l'expiration des dix jours sera considéré selon les termes du paragraphe « garantie ». Aucune garantie de bon fonctionnement ne sera appliquée sauf sur la base d'une clause spécifique convenue par écrit.

### Garantie

Tout produit Castel est garanti pour une période de 12 mois à compter de la date du document de transport. La garantie couvre tous les produits ou parties de ceux-ci qui présentent des défauts de fabrication pendant la période de garantie. Tout vice ou défaut doit être signalé dans les conditions établies par la loi italienne. Le client devra alors renvoyer, à ses frais, les matériaux accompagnés d'une description détaillée des défauts constatés sous réserve de la reconnaissance du coût en cas de défaut constaté. La garantie n'est pas reconnue lorsque les défauts des produits Castel sont dus à des erreurs du client ou de tiers telles que : installations incorrectes, utilisations contraires aux indications fournies par Castel, altérations. Pour tout éventuel défaut ou vice de ses produits, Castel s'engage à les remplacer purement et simplement sans reconnaître, en aucun cas, le droit à l'indemnisation des dommages de toute nature. D'éventuelles interventions correctives, remplacements et réparations effectués par des tiers sur instructions du client doivent être préalablement autorisés par Castel. Castel se réserve le droit d'apporter des changements ou des modifications à ses produits sans préavis et à tout moment.

### Retours de produits non défectueux

Castel n'accepte pas les retours de marchandises qu'elle n'a pas expressément autorisés et qui ne parviennent pas à Castel aux frais du client - CPT « Castel Pessano con Bornago (MI) » Incoterms® 2020.

### Tarifs

Ils s'entendent toujours pour des marchandises EX WORKS-EXW « Magasin Castel di Vimercate (MB) » Incoterms® 2020 et peuvent être modifiés à tout moment en fonction des coûts.

### Litiges

Le tribunal de Milan est compétent pour tout litige. La loi italienne s'applique, à l'exclusion de la Convention ONU de Vienne sur les ventes internationales.

## APPLICATION DE LA DIRECTIVE 2014/68/UE DU PARLEMENT EUROPÉEN ET DU CONSEIL, DU 15 MAI 2014, EN MATIÈRE D'ÉQUIPEMENTS SOUS PRESSION VIS-À-VIS DES PRODUITS CASTEL POUR RÉFRIGÉRATION

La Directive 2014/68/UE (PED Recast) s'applique à la conception, fabrication et évaluation de conformité des équipements sous pression et des ensembles avec une pression maximale admissible « PS » supérieure à 0,5 bar à l'exception des cas énumérés dans l'Article 1, Alinéa 2 de cette même Directive.

La nouvelle Directive PED Recast abroge la directive précédente 97/23/CE, en particulier:

- L'article 13 de la Directive PED Recast, liée à la classification des équipements sous pression, est entré en vigueur à partir du 19 Juin 2015 et abroge l'article 9 de la Directive PED précédente
- Tous les autres articles de la Directive PED Recast sont entrés en vigueur le 19 Juillet 2016, abrogeant tous les articles de la Directive PED précédente. À ce jour, dans les États membres de la Communauté européenne, c'est possible de placer sur le marché que des équipements de pression marqué CE selon PED refonte.

Aux fins de l'Article 2 de la Directive PED Recast, voir les définitions suivantes :

- **Équipements sous pression:** récipients, tuyauteries, accessoires de sécurité et accessoires sous pression.
- **Récipient:** un logement conçu et fabriqué pour contenir les fluides sous pression.
- **Tuyauteries:** les composants d'un conduit destinés au transport de fluides lorsque ceux-ci sont raccordés afin d'être introduits dans un système sous pression.
- **Accessoires de sécurité:** les dispositifs destinés à la protection des appareils sous pression contre le dépassement des limites autorisées.
- **Accessoires sous pression:** dispositifs ayant la fonction de service et dont les logements sont soumis à pressions; par exemple: vannes solénoïdes, robinets en général, indicateurs.
- **Ensembles:** divers équipements sous pression assemblés par un fabricant pour construire un tout intégré et fonctionnant.
- **Pression maximale admissible (PS):** la pression maximum pour laquelle l'équipement est conçu, spécifiée par le fabricant.
- **Température minimum / maximale admissible (TS):** les températures minimum / maximum pour lesquelles l'équipement est conçu, spécifiées par le fabricant.
- **Volume (V):** le volume interne d'une chambre y compris le volume des raccords à la première connexion et le volume des éléments internes permanents.
- **Dimension nominale (DN):** la désignation numérique de la dimension qui est commune à tous les composants d'un système de tuyauteries
- **Fluides:** les gaz, les liquides et les vapeurs à l'état pur et leurs mélanges. Dans l'Article 4 et Annexe II suivante de la Directive PED Recast, les équipements sous pression sont classés par catégories de risque croissant de I à IV en fonction de:
  - État du fluide contenu
  - Classe de dangerosité du fluide contenu
  - Type d'équipement
  - Dimensions et potentiel énergétique; V, DN, PS, PS x V, PS x DN
 et doivent remplir les Conditions Requisites Essentielles de Sécurité établies dans l'Annexe I de la Directive PED Recast.

Les équipements sous pression ayant des caractéristiques inférieures ou similaires aux limites fixées aux points 1.a, 1.b et 1.c et au point 2 de l'Article 4 de la Directive PED Recast ne doivent pas remplir les Conditions Essentielles de Sécurité fixées dans l'Annexe I mais doivent être conçus et fabriqués selon une bonne pratique de fabrication utilisée dans l'un des États membres garantissant la sécurité d'utilisation (Article 4, Paragraphe 3). Ces équipements ne doivent pas porter la marque CE.

Dans l'Article 13 de la Directive, les fluides sont classés en fonction de leur dangerosité, en deux groupes:

- **Groupe 1** qui comprend les substances et les préparations, telles que définies aux points 7 et 8 de l'Article 2 du Règlement CE n° 1272/2008, qui sont classés comme dangereux en conformité avec les classes de danger physique ou à la santé énoncées dans la partie 2 et 3 de l'Annexe I ce règlement. Une liste de 18 classes de fluides dangereux sont présentées au point 1.a de l'article 13 (explosifs, inflammables, oxydants, toxiques).
- **Groupe 2** qui comprend tous les autres substances et préparations non énumérés sur le point 1.a

**Les produits de la série CASTEL POLYHEDRA sont appropriés pour l'utilisation avec des fluides frigorigènes appropriés pour le Groupe 1 et 2, classé A1, A2I et A3 à l'annexe E de la norme EN 378-1: 2016.**

**Les produits de la série CASTEL CLASSIC sont appropriés pour l'utilisation avec des liquides réfrigérants appropriés pour le Groupe 2, classé A1 à l'annexe E de la norme EN 378-1: 2016.**

**Les produits de la série CASTEL GOGREEN sont appropriés pour l'utilisation uniquement avec fluide réfrigérant R744, appropriés pour le Groupe 2, classé A1 à l'annexe E de la norme EN 378-1: 2016.**

## APPLICATION DE LA DIRECTIVE 2011/65/UE DU PARLEMENT EUROPÉEN ET DU CONSEIL, DU 8 JUILLET 2011, SUR LA RESTRICTION RELATIVE À L'UTILISATION DE CERTAINES SUBSTANCES DANGEREUSES DANS LES APPAREILLAGES ÉLECTRIQUES ET ÉLECTRONIQUES VIS-À-VIS DES PRODUITS CASTEL POUR RÉFRIGÉRATION

La Directive 2011/65/UE, mieux connue sous le nom de Directive RoHS 2 ou RoHS-Recast (Restriction of Hazardous Substances), vise à interdire ou limiter l'utilisation de certaines substances dangereuses dans les appareillages électriques et électroniques ainsi qu'à la récupération et élimination écologiquement correctes des déchets d'appareillages électriques et électroniques. La Directive 2011/65/UE et les modifications suivantes apportées par la Directive 2015/863/UE remplacent la précédente Directive 2002/95/CE (RoHS), qui a été abrogée à compter du 3 janvier 2013.

Les dispositions de la Directive RoHS 2 s'appliquent aux AEE (Appareillages

Électriques et Électroniques) qui entrent dans les Catégories 1, 2, 3, 4, 5, 6, 7, 10, 11 énumérées dans l'Annexe 1 de cette même Directive.

Les appareillages appartenant aux catégories 1-“**Grands appareils électroménagers**” et 10-“**Distributeurs automatiques**” sont détaillés à l'Annexe 2 de la Directive 2012/19/UE, RAEE-Recast, (déchets d'appareillages électriques et électroniques) qui remplace la précédente Directive 2002/96/CE, abrogée depuis le 15 février 2014. Dans les listes de l'Annexe 2, figurent entre autres:

- Grands appareils de réfrigération
- Réfrigérateurs
- Congélateurs
- Autres grands appareils électroménagers pour la réfrigération, la conservation et le dépôt des aliments
- Appareils pour le conditionnement
- Autres appareillages pour la ventilation, l'extraction de l'air et le conditionnement
- Distributeurs de boissons chaudes, froides, bouteilles et canettes

L'Article 4 de la Directive RoHS 2 prévoit que les AEE introduites sur le marché, y compris les câbles et les pièces détachées destinés à leur réparation, à leur réutilisation, à la mise à jour de leur fonctionnalité, au renforcement de leurs capacités, ne contiennent pas les substances énumérées dans l'Annexe 2, ainsi que modifié par la Directive 2015/863/UE, à savoir:

- Plomb - (0,1 %)
- Mercure – (0,1 %)
- Cadmium – (0,01 %)
- Chrome hexavalent – (0,1 %)
- Polybromobiphényle (PBB) – (0,1 %)
- Polybromodiphényléther (PBDE) – (0,1 %)
- Phtalate de bis(2-éthylhexyle) (DEHP) – (0,1 %)
- Phtalate de benzyle et de butyle (BBP) – (0,1 %)
- Phtalate de dibutyle (DBP) – (0,1 %)
- Phtalate de di-isobutyle (DIBP) – (0,1 %)

L'Annexe 3 prévoit différentes exemptions sur les restrictions à l'usage qui figurent dans l'Article 4 et l'Annexe 2. Parmi les différentes exemptions prévues, les suivantes intéressent plus particulièrement le secteur de la réfrigération et du conditionnement:

- Le plomb en tant qu'élément d'alliage dans l'acier contenant jusqu'à 0,35 % de plomb en poids (exemption 6a de l'Annexe 3, prorogée jusqu'au 21 juillet 2021 par la Directive UE 2018/739 du 1 mars 2018)
- Le plomb en tant qu'élément d'alliage dans l'acier contenant jusqu'à 0,4 % de plomb en poids (exemption 6b de l'Annexe 3, prorogée jusqu'au 21 juillet 2021 par la Directive UE 2018/740 du 1 mars 2018)
- Plomb comme élément d'alliage dans les alliages de cuivre contenant jusqu'à 4 % de plomb en poids (exemption 6c de l'Annexe 3, prorogée jusqu'au 21 juillet 2021 par la Directive UE 2018/741 du 1 mars 2018)

La société Castel a mis en oeuvre avant 2005, année de transposition des Directives 2002/95/CE et 2002/96/CE par l'État Italien, une enquête détaillée, avec ses propres fournisseurs, dans le but de déterminer la présence ou non des susdites substances dangereuses, aussi bien dans ses propres produits que dans ses processus de production, et de les limiter progressivement. Au terme de cette grande analyse initiale et d'une surveillance constante des produits et des procédés, la société Castel est en mesure de déclarer que tous les produits qu'elle fournit à ses clients sont conformes aux restrictions relatives à l'utilisation de certaines substances dangereuses, définies dans la Directive 2001/65/UE.

De manière spécifique, les produits de la société Castel:

1. Ne contiennent pas de mercure, cadmium, chrome hexavalent, Polybromobiphényles (PBB), Polybromodiphényléthers (PBDE) (DEHP), (BBP), (DBP), (DIBP)
2. Contiennent du plomb comme élément d'alliage dans l'acier, dans l'aluminium et dans les alliages de cuivre dans les limites d'acceptabilité prévues par l'Annexe 3 de la Directive RoHS 2

La société Castel déclare également que tous les produits fournis à ses clients, comme **composants/pièces détachées** utilisés dans les AEE ne doivent pas:

- être marqués CE comme requis dans l'Article 15 de la Directive 2011/65/UE
- être accompagnés d'une Déclaration de Conformité rédigée selon l'Annexe 6 de cette même Directive.

Comme spécifié dans le Chap. 7 - par. Q7.3 et dans le Chap. 8 - par. Q8.5 du Guide RoHS 2 FAQ publié le 12/12/2012 par la Commission Européenne.

## APPLICATION DU RÈGLEMENT 1907/2006/CE DU PARLEMENT EUROPÉEN ET DU CONSEIL, DU 18 DÉCEMBRE 2006, CONCERNANT L'ENREGISTREMENT, L'ÉVALUATION, L'AUTORISATION ET LA RESTRICTION DES SUBSTANCES CHIMIQUES (REACH)

## VIS-À-VIS DES PRODUITS CASTEL POUR RÉFRIGÉRATION

Le Règlement européen 1907/2006/CE concernant l'enregistrement, l'évaluation, l'autorisation et la restriction des substances chimiques, plus connu sous l'acronyme REACH (Registration, Evaluation, Authorisation of Chemicals) a été publié sur la GUCE L136 du 29 mai 2007 et est entré en vigueur dans toute l'Union Européenne le 1er Juin 2007. Ce Règlement requiert le pré-enregistrement et l'enregistrement des substances chimiques fabriquées ou importées en Europe auprès de l'Agence européenne pour les substances chimiques (European Chemicals Agency – ECHA).

La société Castel s'est aussitôt activée pour approfondir les contenus et les finalités de la nouvelle législation dans le but de définir les rôles qu'elle assume dans la chaîne d'approvisionnement et les éventuelles obligations auxquelles elle doit répondre conformément au Règlement REACH.

La société Castel n'est pas un "fabricant" ou un "importateur" de substances et ne doit donc pas obtempérer aux obligations de pré-enregistrement et/ou d'enregistrement.

La société Castel n'est pas un "fabricant" ou un "importateur" de préparations et ne doit donc pas fournir d'informations aux clients sur l'enregistrement des substances contenues dans celles-ci ni d'informations sur la sécurité.

La société Castel n'est pas un "fabricant" ou un "importateur" d'articles qui relâchent des substances dans les conditions normales d'utilisation ou raisonnablement prévisibles (Art. 7.1 du REACH) et ne doit donc pas obtempérer aux obligations de pré-enregistrement et/ou d'enregistrement de ces substances.

La société Castel, vis-à-vis de ses fournisseurs, est un "utilisateur en aval" de substances, préparations et articles utilisés dans leurs processus de production et dans leurs produits. La société a recueilli des informations auprès de tous ses fournisseurs de substances/préparations et produits pour vérifier:

- qu'ils connaissent les contenus et finalités du Règlement REACH
- qu'ils se sont activés pour remplir les obligations leur incombant et prévues par le susdit Règlement
- qu'ils assurent la continuité de leurs fournitures dans le futur

La société Castel est un "fabricant" d'articles envers ses clients et en tant que tel, s'engage à vérifier constamment que dans ses produits:

- les substances sujettes à restriction, énumérées dans l'Annexe XVII, ne sont pas utilisées, de manière non conforme à la restriction, selon ce que prévoit l'Art. 67. du REACH
- les substances extrêmement problématiques, mieux connues sous l'acronyme SVHC (Substance of Very High Concern) énumérées dans la Candidate List et la Authorisation List de l'Annexe XIV, ne sont pas présentes dans des concentrations supérieures à 0,1 % poids/poids. (la limite de 0,1 % relative au poids total de l'article) et qu'elles remplissent toutes les conditions énumérées dans l'Art. 7.2 du REACH. Si cette éventualité se produit, la société Castel s'engage à le communiquer aussitôt à ses clients en fournissant toutes les informations nécessaires pour une utilisation en toute sécurité, selon ce que prévoit l'Art. 33 du REACH.

## APPLICATION DU RÈGLEMENT N° UE 517/2014 DU PARLEMENT EUROPÉEN ET DU CONSEIL, DU 16 AVRIL 2014, RELATIF A CERTAINS GAZ A EFFET DE SERRE FLUORES VIS-A-VIS DES PRODUITS CASTEL POUR REFRIGERATION

Le Règlement européen UE No 517/2014 sur les gaz à effet de serre fluorés, mieux connu comme le Règlement F-Gaz, a été publié sur le JOCE L150 du 20 mai 2014 et est entré en vigueur dans toute l'Union Européenne le 1er janvier 2015, abrogeant le précédent Règlement CE N° 842/2006.

Le nouveau règlement s'articule sur trois principaux sujets traités dans les chapitres suivants:

- Chapitre II: Confinement
- Chapitre III: Introduction sur le marché et contrôle de l'utilisation
- Chapitre IV: Réduction de la quantité d'hydrofluorocarbures introduite sur le marché.

### Confinement

L'article 4 prévoit que les opérateurs d'appareillages contenant des gaz à effet de serre fluorés en quantité égale ou supérieure à 5 tonnes de CO<sub>2</sub> équivalentes doivent effectuer des contrôles pour vérifier la présence éventuelle de fuites. Les appareillages du secteur conditionnement et réfrigération à contrôler sont: appareillages fixes de réfrigération, appareillages fixes de conditionnement de l'air, pompes à chaleur fixes,

chambres réfrigérées de camions et remorques. Sont exclus des contrôles, les appareillages hermétiquement scellés contenant du F-gaz dans une quantité inférieure à 10 tonnes de CO<sub>2</sub> équivalentes pourvu qu'ils soient étiquetés et hermétiquement scellés.

### Introduction sur le marché et contrôle de l'utilisation

**Restrictions à l'introduction sur le marché:** l'article 11 prévoit qu'à compter des dates indiquées, soit interdite l'introduction sur le marché des produits et des appareillages énumérés dans l'Annexe III. Les appareillages du secteur du conditionnement soumis à cette interdiction sont:

Description du produit	Date d'interdiction
Réfrigérateurs et congélateurs pour usage domestique qui contiennent des HFC avec des GWP ≥ 150	01/01/2015
Réfrigérateurs et congélateurs pour usage commercial (appareillages hermétiquement scellés) qui contiennent des HFC avec des GWP ≥ 2500	01/01/2020
Réfrigérateurs et congélateurs pour usage commercial (appareillages hermétiquement scellés) qui contiennent des HFC avec des GWP ≥ 150	01/01/2022
Appareillages fixes de réfrigération contenant des HFC avec des GWP ≥ 2500, à l'exception des appareillages conçus pour fonctionner à des T < -50 °C	01/01/2020
Systèmes de réfrigération centralisés k pour usage commercial avec potentialité nominale ≤ 40 kW qui contiennent des HFC avec des GWP ≥ 150, à l'exception des circuits primaires de système en cascade où l'utilisation de HFC avec GWP <1500 est autorisée.	01/01/2022
Appareillages mobiles de climatisation (appareillage hermétiquement scellés) qui contiennent des HFC avec des GWP ≥ 150	01/01/2020
Systèmes de climatisation mono-split contenant moins de 3 Kg de HFC avec GWP ≥ 750	01/01/2025

**Contrôle de l'utilisation:** l'article 13 prévoit qu'à partir du 1er janvier 2020, l'utilisation de HFC avec GWP ≥ 2500 est interdite pour l'assistance et la maintenance des appareillages de réfrigération avec charge de réfrigérant ≥ 40 tonnes de CO<sub>2</sub> équivalente. L'interdiction ne s'applique pas pour les appareillages conçus pour fonctionner à des T < -50 °C. L'interdiction est repoussé au 1er janvier 2030 pour les HFC régénérés avec GWP ≥ 2500, étiquetés conformément à l'article 12 et pour les HFC recyclés avec les GWP ≥ 2500, déchargés du même équipement sur lequel est effectuée la maintenance.

### Réduction de la quantité d'hydrofluorocarbures introduite sur le marché

L'article 15 prévoit que la quantité de HFC que les producteurs et importateurs peuvent introduire chaque année sur le marché dans l'Union Européenne ne doit pas dépasser la quantité maximum indiquée dans l'Annexe V. La quantité maximum autorisée étant de 100 % en 2015, l'Annexe V prévoit une réduction progressive de la quantité maximum pouvant être commercialisée jusqu'à arriver à 21 % en 2030. À partir du 1er janvier 2017, les appareillages de réfrigération, conditionnement et pompes à chaleur préchargés avec des HFC peuvent être introduits sur le marché uniquement s'ils ne dépassent pas les quantités maximum prévues par l'Annexe V.

L'article 16 prévoit qu'à l'intérieur de cette quantité maximum définie par année, la Commission Européenne attribue, conformément au règlement, des quotas d'émission sur le marché des HFC.

Nous pensons que l'application du Règlement F-Gaz portera d'ici peu de grands changements dans les différents secteurs de la réfrigération même si, dans une moindre mesure, également dans le conditionnement de l'air. L'utilisation de deux réfrigérants considérés primordiaux dans le secteur de la réfrigération, le R404A (GWP = 3922 second AR4) et le R507 (GWP=3985 second AR4) est destinée à se réduire considérablement en l'espace de quelques années jusqu'à disparaître complètement. La même utilisation du R134a (GWP=1430 selon AR4) est destinée à se réduire vu les changements en cours sur la réfrigération domestique et la climatisation automobile. L'utilisation des deux réfrigérants traditionnellement utilisés dans la climatisation, le R407C (GWP = 1774 selon AR4) et le R410A (GWP = 2088 selon AR4) est également destinée à se redimensionner vu les appareillages de climatisation dans l'Annexe III du règlement.

La société Castel s'est aussitôt activée pour approfondir les contenus et les finalités de la nouvelle législation dans le but de vérifier la compatibilité de ses produits avec les nouveaux fluides réfrigérants que les plus grandes maisons productrices proposent comme alternative aux HFC traditionnels destinés à être interdits.

Au cours des deux dernières années, Castel a déjà présenté deux lignes de produit spécifiques à utiliser avec des fluides réfrigérants naturels: une ligne

de produits pour CO<sub>2</sub>, avec différentes pressions d'utilisation, une ligne de produits pour hydrocarbures (R290, R600, R600a)

Parallèlement, depuis 2015 Castel mène une campagne d'essais pour vérifier/valider la compatibilité:

- de ses produits standard, normalement utilisés avec des réfrigérants HFC traditionnels
- des nouveaux produits de la série POLYHEDRA, à placer sur le marché avec la plupart des nouveaux réfrigérants, constituant des alternatives aux produits traditionnels, proposés par les principaux fabricants.

## RACCORDS DES PRODUITS CASTEL

Les produits Castel peuvent être fournis avec différents types de raccords. De manière particulière, les produits Castel sont fabriqués avec des raccords filetés ou avec des raccords à souder. Au Tableau 1, est indiquée l'équivalence entre les codes Castel et les dimensions en pouces. Ces codes sont normalement utilisés dans le marché international. Au Tableau 2, est indiquée l'équivalence entre les codes Castel et les dimensions en millimètres.

## DESCRIPTION DES RACCORDS ACTUELLEMENT UTILISÉS POUR LES PRODUITS CASTEL.

### 1) RACCORDS FILETÉS

Ils peuvent être de trois types différents:

#### FLARE

Raccord fileté (selon SAE J513-92; ASME B1.1-89) pour raccordement avec tuyau en cuivre avec extrémité adéquatement évasée ("évasement") au moyen d'un embout adapté (voir Tableau 3).

#### NPT

Raccord fileté à filetage conique (selon ASME B1.20.1-92) pour le raccordement d'embouts, robinets, robinets, soupapes de sécurité aux réservoirs ou tuyauteries en acier.

#### FPT

Raccord fileté femelle avec filetage GAS cylindrique (selon ISO 228/1) utilisé dans les systèmes hydrauliques pour la jonction d'embouts ou robinets aux réservoirs ou tuyauteries en acier (voir tableau 4).

### 2) RACCORDS À SOUDER.

Ils peuvent être de quatre types différents et sont adaptés pour tuyaux avec diamètre aussi bien en pouces qu'en millimètres:

#### ODS (ou ODF)

Raccord à souder femelle pour tuyau en cuivre. La dimension indiquée correspond au dia-mètre extérieur du tuyau en cuivre à raccorder.

Exemple: Embout 1/2" ODS à souder pouvant recevoir à l'intérieur un tuyau en cuivre d'un diamètre externe de 1/2".

#### ODM

Raccord à souder mâle pour tuyau en cuivre. La dimension indiquée correspond au diamètre extérieur du tuyau en cuivre à raccorder.

Exemple: Embout 16 ODM à souder pouvant être raccordé à un tuyau en cuivre d'un diamètre externe de 16 mm au moyen d'un manchon femelle/femelle M16

#### IDS

Raccord à souder mâle pour tuyau en cuivre. La dimension indiquée correspond au diamètre intérieur du tuyau en cuivre à raccorder.

Exemple: Embout 10 IDS à souder pouvant recevoir à l'extérieur un tuyau en cuivre d'un diamètre interne de 10 mm.

#### W

Raccord à souder pour tuyaux en acier. La dimension indiquée correspond au diamètre extérieur du tuyau en acier à raccorder.

Exemple: Embout 76,1 W à souder pouvant être raccordé à un tuyau en acier d'un diamètre externe de 76,1 mm par soudure électrique bout à bout.



## ALLGEMEINE VERKAUFSBEDINGUNGEN

### Bestellungen

Eine Bestellung setzt grundsätzlich die umfassende Zustimmung des Kunden zu den nachstehend aufgeführten Geschäftsbedingungen von Castel voraus und verpflichtet Castel nicht zur Annahme der Geschäftsbedingungen des Kunden, außer bei Vorliegen einer gültigen anderslautenden, von Castel und dem Kunden unterzeichneten schriftlichen Vereinbarung

### Versand

Der Warenversand erfolgt EX WORKS - EXW „Magazzino Castel di Vimercate (MB)“ gemäß Incoterms® 2020 für den Warenversand innerhalb der EU bzw. FREE CARRIER - FCA „Magazzino Castel di Vimercate (MB)“ gemäß Incoterms® 2020 für den Warenversand in Nicht-EU-Zollbereiche.

### Verpackung

Die Verpackung wird zum Selbstkostenpreis berechnet. Eine Rückgabe der Verpackung ist nicht möglich.

### Lieferzeiten

Die Lieferfristen sind für Castel nicht verbindlich. Bei Lieferverspätungen können somit keinerlei Ansprüche auf Haftung und/oder Zahlung eines Pönales gegenüber Castel erhoben werden. Eventuelle Lieferverspätungen berechtigen nicht zur Aufhebung des Vertrags.

### Bezahlung

Bei Zahlungsrückstand ist Castel zu Aussetzung der Lieferung und Aufhebung der laufenden Verträge berechtigt.

### Reklamationen

Ganz allgemein sind nur Reklamationen, die innerhalb von zehn Tagen ab Erhalt der Waren bei uns eingehen, gültig. Zu eventuellen Werksfehlern o. ä., die während des Einsatzes und nach Ablauf der Zehntagesfrist aufscheinen, siehe die Bedingungen im Abschnitt „Garantie“. Eine Garantie auf einwandfreie Funktion wird ausschließlich nur auf der Grundlage einer schriftlich vereinbarten diesbezüglichen Klausel gewährt.

### Garantie

Für alle Produkte von Castel gilt eine 12-monatige Garantie, beginnend ab dem Datum des Lieferscheins. Die Garantie erstreckt sich auf alle Produkte bzw. Teile davon, bei denen während der Garantiezeit Werksfehler aufscheinen. Die Mängel oder Defekte sind innerhalb der laut italienischem Gesetz vorgesehenen Fristen anzuzeigen. In derartigen Fällen muss der Kunde die Artikel zusammen mit einer detaillierten Beschreibung der festgestellten Fehler auf eigene Kosten, außer bei Kostenübernahme im Falle nachgewiesener Fehlerhaftigkeit, zurückschicken. Sollten die Defekte der Castel-Produkte auf Fehler des Kunden oder Dritter zurückzuführen sein, wie etwa falsche Installation, Einsatz nicht in Übereinstimmung mit den mitgelieferten Vorgaben von Castel oder Änderungseingriffe, erfolgt keine Garantieleistung. Bei Vorliegen eventueller Fehler oder Mängel der Artikel verpflichtet sich Castel lediglich zu deren Umtausch, auf keinen Fall aber zum Ersatz von Schäden welcher Art auch immer. Eventuelle/r Korrektur, Austausch oder Reparatur durch Dritte auf Anweisung des Kunden bedürfen der vorherigen Genehmigung seitens Castel. Castel behält sich das Recht auf kleinere oder größere Änderungen seiner Produkte zu jedem beliebigen Zeitpunkt und ohne Pflicht zur Vorankündigung vor.

### Retouren nicht fehlerhafter Artikel

Warenretouren ohne vorherige ausdrückliche Genehmigung werden von Castel nicht akzeptiert. Die Retouren haben auf Kosten des Kunden zu erfolgen, und zwar an CPT, „Stabilimento Castel Pessano con Bornago (MI)“, gemäß Incoterms® 2020.

### Preise

Alle Preise verstehen sich für Waren mit Lieferung EX WORKS - EXW „Lager Castel di Vimercate (MB)“ gemäß Incoterms® 2020 und können ausgehend von den Herstellungskosten zu jedem beliebigen Zeitpunkt geändert werden.

### Streitigkeiten

Streitigkeiten aller Art unterliegen der Zuständigkeit des Gerichts in Mailand in Anwendung des italienischen Gesetzes und unter Ausschluss des Wiener UN-Übereinkommens über den Internationalen Warenverkauf.

## ANWENDUNG DER RICHTLINIE 2014/68/EU DES EUROPÄISCHEN PARLAMENTES UND RATES VOM 15. MAI 2014, BEZÜGLICH UNTER DRUCK STEHENDER AUSTRÜTUNGEN, HINSICHTLICH DER PRODUKTE VON CASTEL FÜR DIE KÜHLUNG

Die Richtlinie 2014/68/EU (PED 2 oder PED-Recast) kommt auf den Entwurf, die Herstellung und Bewertung der Übereinstimmung der unter Druck stehenden Ausrüstungen und Baugruppen mit einem maximal zulässigen Druck "PS" von mehr als 0,5 bar ausgenommen der in Artikel 1, Abschnitt 2 dieser Richtlinie aufgeführten Fälle zur Anwendung.

Die neue Richtlinie PED Recast ersetzt die vorausgehende Richtlinie 97/23/EU, d.h. im Besonderen:

- Artikel 13 der Richtlinie PED Recast, bezüglich der Klassifizierung der Druckgeräte, ist am 19. Juni 2015 in Kraft getreten und ersetzt Artikel 9 der früheren PED-Richtlinie.

- Alle anderen Artikel der Richtlinie PED Recast sind ab dem 19. Juli 2016 in Kraft getreten und ersetzen alle Artikel der früheren PED-Richtlinie. Ab diesem Datum ist es in den Mitgliedstaaten der Europäischen Gemeinschaft nur möglich, Druckgeräte mit der CE Kennzeichnung gemäß PED Recast auf den Markt zu bringen.

Zum Zwecke des Artikels 2 der Richtlinie PED Recast siehe in den folgenden Definitionen:

- **Druckgeräte:** Behälter, Leitungen, Sicherheitszubehör und Druckzubehör.
- **Behälter:** ein zur Aufnahme von unter Druck stehenden Flüssigkeiten entworfenen und gebautes Gefäß.
- **Leitungen:** die Bauteile einer für die Förderung von Flüssigkeiten dienenden Leitung, vorausgesetzt diese sind angeschlossen, um in ein Drucksystem aufgenommen zu werden.
- **Sicherheitszubehör:** die zum Schutz der Druckgeräte vor einer Überschreitung der zulässigen Grenzwerte bestimmten Vorrichtungen.
- **Druckzubehör:** Vorrichtung mit Hilfsfunktionen, deren Anschlüsse unter Druck stehen, wie zum Beispiel: magnetventile, Ventile im Allgemeinen, Anzeigen.
- **Baugruppen:** verschiedene Druckgeräte, die von einem Hersteller zusammengebaut werden, um eine integrierte und funktionstüchtige Einheit zu bilden.
- **Zulässiger Höchstdruck (PS):** der vom Hersteller angegebene Höchstdruck, für den das Gerät entworfen wurde.
- **Zulässige Mindest-/Höchst-Temperatur (TS):** die vom Hersteller angegebene Mindest-/Höchst-Temperatur, für die das Gerät entworfen wurde.
- **Volumen (V):** das Volumen im Inneren einer Kammer, einschließlich des Volumens der Anschlüsse bei der ersten Verbindung sowie ausgenommen des Volumens der dauerhaften Elemente im Inneren.
- **Nennabmessung (DN):** die numerische Bezeichnung der Größe, die allen Bauteilen eines Leitungssystems gemein ist.
- **Flüssigkeit:** die Gase, Flüssigkeiten und Dämpfe im reinen Zustand sowie ihre Mischungen.

In Artikel 4 sowie in der nachfolgenden Anlage II der Richtlinie werden die Druckgeräte in Klassen mit steigender Gefahr von I bis IV eingeteilt, in Abhängigkeit von:

- Zustand des enthaltenen Flüssigkeit;
  - Gefahrenklasse des enthaltenen Flüssigkeit;
  - Geräteart;
  - Abmessungen und Energiepotential; V, DN, PS, PS x V, PS x DN und müssen die grundlegenden Sicherheitsanforderungen erfüllen, die in Anlage I der PED 2 Richtlinie festgelegt sind.
- Druckgeräte mit niedrigeren oder gleichen Eigenschaften, wie in den Punkten 1.a, 1.b und 1.c sowie in Punkt 2 des Artikels 4 der PED 2 Richtlinie festgelegt, müssen die in Anlage I festgelegten, grundlegenden Sicherheitsanforderungen nicht erfüllen, sondern entsprechend einer korrekten Vorgehensweise entworfen und hergestellt werden, die in einem der Mitgliedsstaaten zur Anwendung kommt sowie die Sicherheit der Anwendung gewährleistet (Artikel 4, Abschnitt 3). Diese Geräte müssen keine CE-Kennzeichnung tragen. In Artikel 13 der Richtlinie werden die Fluide nach ihrer Gefährlichkeit in zwei Gruppen unterteilt:

- **Gruppe 1**, umfasst Stoffe und Gemische, laut Definition in den Punkten 7 und 8 des Artikels 2 der EG-Regelung Nr. 1272/2008, die gemäß der in Teil 2 und 3 von Anhang I zu dieser Regelung aufgeführten körperlichen oder gesundheitlichen Gefahrenklassen als gefährlich eingestuft werden. Eine Liste von 18 Klassen gefährlicher Fluide ist unter Punkt 1. des Artikels 13 zu sehen (explosive, entflammbar, oxidierend, toxisch).
- **Gruppe 2**, umfasst Stoffe und Gemische, die nicht unter Punkt 1.a aufgeführt sind

Die Produkte der CASTEL POLYHEDRA-Serie eignen sich zur Verwendung mit Kühlfüssigkeiten der Gruppen 1 und 2, die in Anhang E der Norm EN 378-1: 2016 als A1, A2L und A3 eingestuft sind.

Die Produkte der CASTEL CLASSIC-Serie eignen sich zur Verwendung mit Kühlfüssigkeiten der Gruppe 2, die in Anhang E der Norm EN 378-1:2016 als A1 eingestuft sind.

Die Produkte der CASTEL GOGREEN-Serie eignen sich zur Verwendung mit der Kühlfüssigkeit R744 der Gruppe 2, die in Anhang E der Norm EN 378-1:2016 als A1 eingestuft ist.

## ANWENDUNG DER RICHTLINIE 2011/65/EU DES EUROPÄISCHEN PARLAMENTES UND RATES VOM FREITAG, 8. JULI 2011, BEZÜGLICH DER EINSCHRÄNKUNG DES GEBRAUCHS BESTIMMTER GEFÄHRENSTOFFE IN ELEKTRISCHEN UND ELEKTRONISCHEN GERÄTEN HINSICHTLICH DER PRODUKTE VON CASTEL FÜR DIE KÜHLUNG

Die Richtlinie 2011/65/EU, die besser als Richtlinie RoHS 2 oder RoHS-Recast (Restriction of Hazardous Substances) bekannt ist, zielt auf eine



Beschränkung oder ein Verbot des Einsatzes bestimmter Gefahrenstoffe in elektrischen und elektronischen Geräten sowie auf die Rückgewinnung und umweltgerechte Entsorgung elektrischer und elektronischer Geräte. Die Richtlinie 2011/65/EU und mit den durch die Richtlinie 2015/863/EU vorgenommenen Änderungen ersetzt die bisherige Richtlinie 2002/95/EG (RoHS), die ab dem 3. Januar 2013 unwirksam geworden ist.

Die Bestimmungen der Richtlinie RoHS 2 kommen auf die elektrischen und elektronischen Geräte der Kategorien 1, 2, 3, 4, 5, 6, 7, 10, 11 der Anlage 1A dieser Richtlinie zur Anwendung.

Die zu den Kategorien 1-“Haushaltsgroßgeräte” und 10-“Automatische Ausgabegeräte” werden in Anlage 2 der Richtlinie 2012/19/EU, RAEE-Recast, (Abfälle von elektrischen und elektronischen Geräten) näher erläutert, die die vorausgehende Richtlinie 2002/96/CE ersetzt, die ab 15. Februar 2014 ihre Wirksamkeit verliert.

In den Listen von Anlage 2 sind unter anderem enthalten:

- Große Kühlgeräte;
- Kühlschränke;
- Gefrierschränke;
- Andere große elektrische Hausgeräte zur Kühlung, Aufbewahrung und Lagerung von Lebensmitteln;
- Klimageräte;
- Andere Geräte zur Lüftung, Luftanleitung und Klimatisierung;
- Automaten für Heiß- und Kaltgetränke, Flaschen und Büchsen.

Artikel 4 der Richtlinie RoHS 2 sieht vor, dass die auf den Markt gebrachten elektrischen und elektronischen Geräte einschließlich Kabeln und Ersatzteilen für ihre Reparatur, Wiederverwendung, Aktualisierung ihrer Funktionen zur Erweiterung ihrer Fähigkeiten gemäß den Änderungen durch die Richtlinie 2015/863/EU nicht die in Anlage 2 aufgeführten Stoffe enthalten dürfen, d.h.:

- Blei - (0,1 %)
- Quecksilber - (0,1 %)
- Cadmium - (0,01 %)
- Sechswertiges Chrom - (0,1 %)
- Polybromierte Biphenyle - (PBB) (0,1%)
- Polybromierte Diphenyläther - (PBDE) (0,1%)
- Bis(2-ethylhexyl)phthalat (DEHP) – (0,1%)
- Benzylbutylphthalat (BBP) – (0,1%)
- Dibutylphthalat (DBP) – (0,1%)
- Diisobutylphthalat (DIBP) – (0,1%)

Anhang 3 sieht mehrere Ausnahmen von den in Artikel 4 und Anhang 2 genannten Verwendungsbeschränkungen vor. Für den Bereich Kälte- und Klimaanlage sind folgende Ausnahmen von besonderem Interesse:

- Blei als Legierungselement in Stahl mit einem Massenanteil von höchstens 0,35 % Blei (Ausnahme 6a Anhang 3, verlängert bis 21. Juli 2021 von der EU-Richtlinie 2018/739 vom 1. März 2018)
- Blei als Legierungselement in Aluminium mit einem Massenanteil von höchstens 0,4 % Blei (Ausnahme 6b Anhang 3, verlängert bis 21. Juli 2021 von der EU-Richtlinie 2018/740 vom 1. März 2018)
- Blei als Legierungselement in Kupferlegierungen mit einem Massenanteil von höchstens 4 % Blei (Ausnahme 6c Anhang 3, verlängert bis 21. Juli 2021 von der EU-Richtlinie 2018/741 vom 1. März 2018)

Über eine lange Zeit vor dem Jahre 2005 hat die Firma Castel zusammen mit ihren Lieferanten eine sorgfältige Untersuchung eingeleitet, um das Vorhandensein oder Fehlen der oben erwähnten gefährlichen Stoffe sowohl bei ihren Produkten als auch ihren Produktionsprozessen festzustellen und diese zunehmend zu beseitigen.

Am Ende dieser umfassenden anfänglichen Analyse und einer ständigen Überwachung der Produkte und Prozesse ist die Firma Castel in der Lage zu erklären, dass alle an ihre Kunden gelieferten Produkte die Gebrauchsbeschränkungen bestimmter Gefahrenstoffe erfüllen, die in der Richtlinie 2011/65/UE festgelegt werden.

Im Besonderen gilt für die Produkte der Firma Castel, das:

1. sie kein Quecksilber, kein Cadmium, kein sechswertiges Chrom, keine polybromierten Biphenyle (PBB) sowie keine polybromierten Diphenyläther (PBDE), Bis(2-ethylhexyl)phthalat (DEHP), Benzylbutylphthalat (BBP), Dibutylphthalat (DBP) und Diisobutylphthalat (DIBP) enthalten;
2. Blei nicht als Legierungselement von Stahl-, Aluminium- und Kupferlegierungen innerhalb der durch die Anlage 3 der Richtlinie RoHS 2 vorgesehenen Zulässigkeitsgrenzen enthalten ist.

Die Firma Castel erklärt außerdem, dass alle ihren Kunden gelieferten Produkte, da es sich um **Bauteile/Ersatzteile** handelt, die in elektrischen und elektronischen Geräten verwendet werden, nicht:

- die CE-Kennzeichnung tragen müssen, wie in Artikel 15 der Richtlinie 2011/65/UE gefordert wird;
- durch eine Konformitätserklärung begleitet werden müssen, die gemäß Anlage 6 der gleichen Richtlinie erstellt wurde.

Wie im Kap. 7 - Abschn. Q7.3 und im Kap. 8 - Abschn. Q8.5 der Anleitung RoHS 2 FAQ, veröffentlicht am 12/12/2012 von der Europäischen Kommission vorgeschrieben.

## ANWENDUNG DER VERORDNUNG 1907/2006/EG DES EUROPÄISCHEN PARLAMENTES UND RATES VOM 18. DEZEMBER 2006, BEZÜGLICH DER REGISTRIERUNG, BEWERTUNG, ZULASSUNG UND BESCHRÄNKUNG DER CHEMIKALIEN (REACH) HINSICHTLICH DER PRODUKTE VON CASTEL FÜR DIE KÜHLUNG

Die Europäische Verordnung 1907/2006/EG bezüglich der Registrierung, Bewertung, Zulassung und Beschränkung der Chemikalien, die besser unter der Abkürzung REACH (Registration, Evaluation, Authorisation of Chemicals) bekannt ist, wurde im EG-Amtsblatt GUCE L136 vom 29. Mai 2007 veröffentlicht und ist in der gesamten Europäischen Gemeinschaft am 1. Juni 2007 in Kraft getreten. Diese Regelung fordert die Vorab-Registrierung und Registrierung in Europa hergestellter oder importierter Chemikalien bei der Europäischen Agentur für Chemikalien (European Chemicals Agency – ECHA).

Die Firma Castel hat sich umgehend dafür eingesetzt, die Inhalte und Zielstellungen der neuen Gesetzgebung zu vertiefen, um die von ihr in der Bevorratungskette übernommenen Rollen und eventuell gemäß der REACH-Verordnung zu erfüllende Pflichten festzulegen.

Die Firma Castel ist kein "Hersteller" oder "Importeur" von Stoffen und muss somit nicht die Pflichten der Vorab-Registrierung und / oder Registrierung erfüllen.

Die Firma Castel ist kein "Hersteller" oder "Importeur" von Präparaten und muss den Kunden somit weder Informationen zur Registrierung der darin enthaltenen Stoffe noch zur Sicherheit erteilen.

Die Firma Castel ist kein "Hersteller" oder "Importeur" von Artikeln, die bei normalem oder vernünftigerweise vorhersehbarem Gebrauch (Art. 7.1 REACH) Stoffe freisetzen, und muss deshalb nicht die Pflichten zur Vorab-Registrierung und / oder Registrierung dieser Stoffe erfüllen.

Die Firma Castel ist gegenüber ihren Zulieferern ein "nachgeordneter Anwender" von Stoffen, Präparaten und Artikeln, die in ihren Produktionsprozessen und Produkten verwendet werden. Die Firma hat seit einiger Zeit bei allen ihren Zulieferern von Stoffen / Präparaten und Artikelneine Sammlung von Daten eingeleitet, um zu prüfen, ob:

- diese Kenntniss von den Inhalten und Zielstellungen der REACH-Verordnung haben;
- diese sich dafür einsetzen, die ihnen laut der vorgenannten Verordnung obliegenden Pflichten zu erfüllen;
- die Unterbrechungslosigkeit ihrer Lieferungen in der Zukunft gewährleisten;

Die Firma Castel ist gegenüber ihren Kunden ein "Hersteller" von Artikeln und innerhalb dieser Rolle ständig darum bemüht, zu prüfen, ob ihre Produkte:

- die in Anlage XVII aufgeführten, einer Beschränkung unterliegenden Stoffe nicht abweichend von der Beschränkung benutzt werden, die in Art. 67 der REACH-Verordnung vorgesehen ist;
- nicht in Konzentrationen von mehr als 0,1% Gewichtsanteil vorhanden sind. (der Grenzwert von 0,1% bezieht sich auf das Gesamtgewicht des Artikels) keine besonders besorgniserregenden Stoffe enthalten sind, die besser unter der Abkürzung SVHC (Substance of Very High Concern) bekannt und in der Candidate List und in der Authorisation List der Anlage XIV aufgeführt sind, sowie gleichzeitig alle in Art. 7.2 der REACH-Verordnung aufgeführten Bedingungen erfüllt sind. Sollte dieser Fall eintreten, verpflichtet sich die Firma Castel, dies ihren Kunden rechtzeitig mitzuteilen und für einen sicheren Gebrauch gemäß Art. 33 der REACH-Verordnung ausreichende Informationen bereit zu stellen. Für weitere Informationen zur aktuellen SVHC Candidate List empfehlen wir unseren Kunden, die Internetseite [http://echa.europa.eu/chem\\_data/candidate\\_list\\_table\\_en.asp](http://echa.europa.eu/chem_data/candidate_list_table_en.asp) der Europäischen Agentur ECHA.

## ANWENDUNG DER VERORDNUNG (EU) NR. 517/2014 DES EUROPÄISCHEN PARLAMENTES UND RATES VOM 16. APRIL 2014, ÜBER FLUORIERTER TREIBHAUSGASE (F-GAS) HINSICHTLICH DER PRODUKTE VON CASTEL FÜR DIE KÜHLUNG

Die Europäische Regelung EU Nr. 517/2014 zu on fluorierten Treibhausgasen, die sogenannte F-Gas-Regelung, wurde im GUCE L150 mit Datum vom 20. Mai 2014 veröffentlicht und trat in der Europäischen Union am 1. Januar 2015 in Kraft, womit die frühere Regelung EC Nr. 842/2006 ersetzt wurde. Die neue Regelung gliedert sich in den folgenden Kapiteln in drei Hauptthemen.

- Kapitel II: Eingrenzung
- Kapitel III: Einführung auf dem Markt und Kontrolle des Einsatzes
- Kapitel IV: Reduzierung der auf dem Markt eingeführten Menge von Fluorkohlwasserstoffen

### Eingrenzung

Im Artikel 4 legt fest, dass die Nutzer von Geräten, die fluoridierte Treibhausgase in Mengen von 5 Tonnen CO<sub>2</sub> oder gleichwertig mehr enthalten, absichern müssen, dass die Geräte auf Leckstellen geprüft werden. Die folgenden Geräte zur Klimatisierung und Kühlung müssen geprüft werden: stationäre Kühlgeräte, stationäre Klimageräte, stationäre Wärmepumpen, Kühlaggregate von Lastwagen und Anhängern, hermetisch abgedichtete Geräte, die fluoridierte Treibhausgase in Mengen von weniger als 10 Tonnen CO<sub>2</sub> gleichwertig enthalten, unterliegen keiner Pflicht zur Kontrolle auf Leckstellen, wenn sie als hermetisch abgedichtet beschildert sind.

### Einführung auf dem Markt und Kontrolle des Einsatzes

**Beschränkung bei der Einführung auf dem Markt:** Artikel 11 legt fest, dass die Einführung von Produkten und Geräten auf dem Markt, die im Anhang Annex III aufgeführt sind, ab dem in diesem Anhang angegebenen Datum untersagt ist. In Anhang III aufgeführte Kühl- und Klimageräte sind:

Beschreibung des Produktes	Verbotsdatum
Haushaltskühlschränke und -tiefkühlschränke, die HFCs mit GWP $\geq 150$ enthalten	01/01/2015
Kühlschränke und Tiefkühlschränke für gewerbliche Zwecke (hermetisch abgedichtete Geräte), die HFCs mit GWP $\geq 2500$ enthalten	01/01/2020
Kühlschränke und Tiefkühlschränke für gewerbliche Zwecke (hermetisch abgedichtete Geräte), die HFCs mit GWP $\geq 150$ enthalten	01/01/2022
Stationäre Kühlgeräte, die HFCs mit GWP $\geq 2500$ enthalten, mit Ausnahme von Geräten, die für den Betrieb bei T < -50 °C vorgesehen sind	01/01/2020
Zentralisierte Multipack-Kühlsysteme zum gewerblichen Gebrauch mit einer Nennkapazität $\geq 40$ kW, die HFCs mit $\geq 150$ , mit Ausnahme des Primärkreises von Kaskadensystemen enthalten, wo HFCs mit GWP < 1500 verwendet werden können.	01/01/2022
Mobile Geräte zur Raumklimatisierung (hermetisch abgedichtete Geräte), die HFC mit GWP $\geq 150$ enthalten	01/01/2020
Single split Luft-Klimatisiersysteme, die weniger als 3 kg HFCs mit GWP $\geq 750$ enthalten	01/01/2025

**Kontrolle des Einsatzes:** Artikel 13 legt fest, dass der Einsatz von HFCs mit GWP  $\geq 2500$  zum Betrieb oder zur Wartung von Kühlgeräten mit einer Füllmenge von  $\geq 40$  Tonnen CO<sub>2</sub> gleichwertig, ab dem 1. Januar 2020 untersagt werden. Dieses Verbot kommt nicht bei Geräten zur Anwendung, die für einen Betrieb bei T < -50 °C vorgesehen sind, und wird auf den 1. Januar 2030 bei zurückgewonnenen HFCs mit GWP  $\geq 2500$  hinausgeschoben, die entsprechend Artikel 12 gekennzeichnet sind, sowie bei recycelten HFCs mit GWP  $\geq 2500$ , die aus dem gleichen Gerät während der Wartung zurückgewonnen wurden.

### Reduzierung der auf dem Markt eingeführten Menge von Fluorkohlwasserstoffen

Artikel 15 legt fest, dass die Menge von HFCs, zu deren Einleitung auf dem Markt der EU die Hersteller und Importeure pro Jahr berechtigt sind, die Höchstmenge des betreffenden Jahres nicht überschreiten darf, die gemäß Anhang V berechnet wurde. Beträgt die zulässige Höchstmenge des Jahres 2015 100% sieht Anhang V eine zunehmende Reduzierung der maximal vermarkt baren Menge von bis zu 21% im Jahre 2030 vor. Ab dem 1. Januar 2017 dürfen auch Kühl-, Luftklimatisier- und Wärmepumpengeräte, die mit HFCs befüllt werden, nicht auf den Markt gebracht werden, es sei denn, die Füllmenge an HFCs wird zum Anteilssystem von Anhang V hinzugerechnet. Artikel 16 legt fest, dass die Europäische Kommission jedes Jahr den die Regelung erfüllenden Herstellern HFCs-Anteile zuweist, die unter Berücksichtigung der für dieses Jahr im Anhang V festgelegten Höchstmenge auf den Markt gebracht werden können.

Wir sind der Meinung, dass die Regelung zum F-Gas bald zu großen Veränderungen bei der Kühlung und in geringerem Maße auch bei der Luftklimatisierung führen wird. Es wird erwartet, dass der Einsatz von zwei Kältemitteln, der bei den Kühlsystemen als primär angesehen wird, d.h., R404A (GWP = 3922 gemäß AR4) und R507 (GWP = 3985 gemäß AR4), innerhalb weniger Jahre stark zurückgehen wird bis er vollständig entfällt. Gleichfalls wird der Einsatz von R134a (GWP = 1430 gemäß AR4) unter Berücksichtigung der Veränderungen bei der Kühlung im Haushalt und der Luftklimatisierung in Autos sinken. Der Gebrauch der beiden herkömmlichen Kältemittel zur Luftkühlung, R407C (GWP = 1774 gemäß AR4) und R410A (GWP = 2088 gemäß AR4) wird sich in Anbetracht der in Anhang III der Regelung erwähnten Geräte nur unwahrscheinlich verringern.

Die Firma Castel hat sofortige Maßnahmen eingeleitet, um die Inhalte und Zwecke der neuen Gesetzgebung zu vertiefen, damit die Kompatibilität ihrer Produkte zu den neuen Kühlfluiden zu prüfen, die die meisten Hersteller als Alternative zum herkömmlichen HFC auf Grund des Verbots anbieten.

In den vergangenen zwei Jahren hat die Firma Castel bereits zwei spezifische Produktlinien mit Einsatz natürlicher Kältemittel vorgestellt: eine Produktlinie für CO<sub>2</sub>, mit unterschiedlichem Betriebsdruck, eine Produktlinie für Kohlenwasserstoffe (R290, R600, R600a).

Ab dem Jahr 2015 führte Castel gleichzeitig eine Testkampagne durch, um die Kompatibilität folgender Produkte zu prüfen und zu bestätigen:

- Kompatibilität der Standardprodukte, die normalerweise mit herkömmlichen HFKW-Kältemitteln verwendet werden
  - und der neuen Produkte der POLYHEDRA-Serie, die auf den Markt gebracht werden sollen
- mit einem Großteil der neuen Kältemittel als Alternative zu den herkömmlichen, die von den großen Herstellern angeboten werden.

## ANSCHLÜSSE DER PRODUKTE VON CASTEL

Die Produkte von Castel können mit unterschiedlichen Anschlussarten geliefert werden. Im Besonderen werden die Produkte von Castel mit Schraub- oder Schweißanschlüssen gebaut.

Tabelle 1 enthält die Beziehung zwischen den Codes von Castel und den Abmessungen in Zoll. Dieses Codes werden üblicherweise auf dem internationalen Markt verwendet. Tabelle 2 enthält die Beziehung zwischen den Codes von Castel und den Abmessungen in Millimetern.

## BESCHREIBUNG DER DERZEIT FÜR DIE PRODUKTE VON CASTEL VERWENDETEN ANSCHLÜSSE.

### 1) SCHRAUBANSCHLÜSSE.

Möglich sind drei verschiedene Arten:

#### FLARE

Schraubanschluss (gemäß SAE J513-92; ASME B1.1-89) zum Anschluss an Kupferrohr mit einem entsprechend aufgeweiteten Ende, d.h. mit "Bördelung" durch einen geeigneten Stutzen (siehe Tabelle 3).

#### NPT

Schraubanschluss mit Kegengewinde (gemäß ASME B1.20.1-92) zum Anschluss von Verbindungen, Hähnen, Sicherheitsventilen von Behältern oder Stahlrohren.

#### FPT

Schraubanschluss mit Innengewinde mit zylinderförmigem GAS-Gewinde (gemäß ISO 228/1), verwendet in der Hydraulik zum Anschluss von Verbindungen oder Hähnen von Behältern oder Stahlrohren (siehe Tabelle 4).

### 2) SCHWEISSANSCHLÜSSE.

Hier sind vier Arten möglich, die sich für Rohre mit einem sowohl in Zoll als auch in Millimeter angegebenen Durchmesser eignen:

#### ODS (ODER ODF)

Schweißanschluss mit Innengewinde für Kupferrohr. Die angegebene Abmessung entspricht dem Außendurchmesser des Kupferrohres, zu dem der Anschluss hergestellt wird.

Beispiel: 1/2" ODS Schweißanschluss zur Aufnahme eines Kupferrohres mit einem Außendurchmesser von 1/2" in seinem Inneren.

#### ODM

Schweißanschluss mit Außengewinde für Kupferrohr. Die angegebene Abmessung entspricht dem Außendurchmesser des Kupferrohres, zu dem der Anschluss hergestellt wird. Beispiel: 16 ODM Schweißanschluss, geeignet zur Verbindung mit einem Kupferrohr mit einem Außendurchmesser von 16 mm mittels einer Muffe Innengewinde/Innengewinde M16.

#### IDS

Schweißanschluss mit Außengewinde für Kupferrohr. Die angegebene Abmessung entspricht dem Innendurchmesser des Kupferrohres, zu dem der Anschluss hergestellt wird.

Beispiel: 10 IDS Schweißanschluss zur Aufnahme eines Kupferrohres mit einem Innendurchmesser von 10 mm an seinem Äußeren.

#### W

Schweißanschluss für Stahlrohre. Die angegebene Abmessung entspricht dem Außendurchmesser des Stahlrohres, zu dem der Anschluss hergestellt wird.

Beispiel: 76,1 W Schweißanschluss zur Verbindung zu einem Stahlrohr mit einem Außendurchmesser von 76,1 mm mittels elektrischem Kopfschweißen.





## TENUTA VERSO L'ESTERNO

Tutti i prodotti elencati nel presente Catalogo sono sottoposti singolarmente, oltre che a prove funzionali mirate, a prove di tenuta sotto pressione. Il tasso di perdita ammesso verso l'esterno, rilevabile durante le prove, è in accordo a quanto previsto nelle norme:

- EN 12178: 2016 – Impianti di refrigerazione e pompe di calore  
Indicatori del livello del liquido - Requisiti, prove e marcatura
- EN 12284: 2003 – Impianti di refrigerazione e pompe di calore  
Valvole – Requisiti, prove, marcatura
- EN 14276-1: 2020 – Attrezzature a pressione per sistemi di refrigerazione e pompe di calore  
Parte1: Recipienti – Requisiti generali
- EN ISO 14903: 2017 – Impianti di refrigerazione e pompe di calore  
Procedura di qualifica delle tenute dei componenti e dei giunti.

## RESISTENZA A PRESSIONE

Tutti i prodotti Castel, se sottoposti a prova idrostatica, garantiscono una resistenza a pressione almeno pari a 1,43 x PS secondo quanto previsto dalla Direttiva 2014/68/UE.

Tutti i prodotti Castel, se sottoposti a prova di scoppio, garantiscono una resistenza a pressione almeno pari a 3 x PS secondo quanto previsto dalla norma EN 378-2: 2016.

Numerosi fra i prodotti Castel possono garantire una resistenza alla pressione di scoppio pari o superiore a 5 x PS in accordo a quanto prevede la norma UL 207: 2020.

## EXTERNAL LEAKAGE

All the products illustrated in this Catalogue are submitted, one by one, to tightness tests as well as specific functional tests. The allowable external leakage, measurable during the test, complies with the requirements of standards:

- EN 12178: 2016 – Refrigerating systems and heat pumps  
Liquid level indicating devices - Requirements, testing and marking
- EN 12284: 2003 – Refrigerating systems and heat pumps  
Valves - Requirements, testing and marking
- EN 14276-1: 2020 – Pressure equipment for refrigerating systems and heat pumps  
Part 1: Vessels – General requirements
- EN ISO 14903: 2017 – Refrigerating systems and heat pumps  
Qualification of tightness of components and joints

## PRESSURE CONTAINMENT

All Castel products, if submitted to hydrostatic test, guarantee a pressure strength at least equal to 1,43 x PS in compliance with the Directive 2014/68/EU.

All Castel products, if submitted to burst test, guarantee a pressure strength at least equal to 3 x PS according to the EN 378-2: 2016 Standard.

A great number of Castel products can guarantee a higher pressure strength, equal to 5 x PS according to the Standard UL 207: 2020.

## ÉTANCHÉITÉ VERS L'EXTÉRIEUR

Tous les produits figurant dans ce catalogue sont soumis individuellement, en plus de tests fonctionnels ciblés, à des essais d'étanchéité sous pression. Le taux de perte admis vers l'extérieur, détectable pendant les tests, est conforme à ce qui est prévu par les normes :

- EN 12178: 2016 – Systèmes de réfrigération et pompes à chaleur  
Indicateurs de liquide – Exigences, essais et marquage
- EN 12284: 2003 – Systèmes de réfrigération et pompes à chaleur  
Vannes – Exigences, essais, marquage
- EN 14276-1: 2020 – Équipements sous pression pour systèmes de réfrigération et pompes à chaleur  
Partie1 : Réceptacles – Exigences générales
- EN ISO 14903: 2017 – Systèmes de réfrigération et pompes à chaleur  
Qualification de l'étanchéité des composants et des joints.

## RÉSISTANCE À LA PRESSION

S'ils sont soumis à un essai hydrostatique, tous les produits Castel assurent une résistance à la pression d'au moins 1,43 x PS selon les dispositions de la Directive 2014/68/UE.

Si soumis à un essai d'éclatement, tous les produits Castel assurent une résistance à la pression d'au moins 3 x PS selon les dispositions de la norme EN 378-2: 2016.

Nombreux sont les produits Castel pouvant garantir une résistance à la

pression d'éclatement égale ou supérieure à 5 x PS conformément aux dispositions de la norme UL 207: 2020.

## ABDICHTUNG NACH AUSSEN

Alle Produkte dieses Katalogs werden einzeln nicht nur gezielten Funktionstests sondern auch Dichtheitsstests unter Druck unterzogen. Der zulässige und bei den Tests messbare Verlust nach außen entspricht den Vorgaben in den Normen:

- EN 12178: 2016 – Kälteanlagen und Wärmepumpen –  
Flüssigkeitsstandanzeiger – Anforderungen, Prüfung und  
Kennzeichnung
- EN 12284: 2003 – Kälteanlagen und Wärmepumpen – Ventile –  
Anforderungen, Prüfung und Kennzeichnung
- EN 14276-1: 2020 – Druckgeräte für Kälteanlagen und Wärmepumpen  
– Teil 1: Behälter – Allgemeine Anforderungen
- EN ISO 14903: 2017 – Kälteanlagen und Wärmepumpen - Qualifizierung  
der Dichtheit der Bauteile und Verbindungen

## DRUCKFESTIGKEIT

Alle Produkte von Castel garantieren, wenn sie einem hydrostatischen Test unterzogen werden, eine Druckfestigkeit von mindestens 1,43 x PS gemäß den Vorgaben in der Richtlinie 2014/68/EU.

Alle Produkte von Castel garantieren, wenn sie einem Berstest unterzogen werden, eine Druckfestigkeit von mindestens 3 x PS gemäß den Vorgaben in der Norm EN 378-2: 2016.

Zahlreiche der Produkte von Castel können eine Widerstandsfähigkeit gegenüber dem Berstdruck von mindestens 5 x PS entsprechend den Vorgaben in der Norm UL 207: 2020 garantieren.



## **PRODOTTI IDONEI PER REFRIGERANTI IDROCARBURI**

I prodotti per refrigeranti idrocarburi presentati in questo catalogo possono essere impiegati con i seguenti fluidi frigoriferi: R290 (propano), R600 (butano), R600a (isobutano) e R1270 (propilene).

Questi refrigeranti sono classificati come fluidi infiammabili appartenenti al Gruppo di sicurezza A3 secondo la norma EN 378-1: 2016.

I suddetti prodotti devono essere utilizzati esclusivamente su sistemi frigoriferi che siano conformi alle normative vigenti in materia di fluidi refrigeranti infiammabili (serie EN 60335).

Interventi d'installazione, manutenzione e riparazione devono essere condotti solamente da personale autorizzato, qualificato a operare su impianti con refrigeranti infiammabili.



## **PRODUCTS SUITABLE FOR HYDROCARBONS REFRIGERANTS**

The products for hydrocarbons refrigerants shown in this catalogue can be used with the following refrigerant fluids: R290 (propane), R600 (butane) and R600a (isobutane) and R1270 (propylene).

These refrigerants are classified as flammable fluids proper to Safety Group A3 according to EN 378-1: 2016 Standard.

The aforesaid products must be used solely on refrigerating systems that are in compliance with regulations about flammable refrigerant fluids (series EN 60335).

Only authorized persons, qualified to work on refrigerating systems containing flammable hydrocarbons, may do installation, maintenance and repair.



## **PRODUITS ADÉQUATS POUR FLUIDES RÉFRIGÉRANTS HYDROCARBURES**

Les produits pour réfrigérants hydrocarbures présentés dans ce catalogue peuvent être utilisés avec les fluides réfrigérants suivants: R290 (propane), R600 (butane), R600a (isobutane) et R1270 (propylène).

Ces réfrigérants sont classés comme des fluides inflammables appartenant au Groupe de sécurité A3 selon la norme EN 378-1: 2016.

Les susdits produits doivent être utilisés exclusivement sur des systèmes frigorifiques qui soient conformes aux normes en vigueur en matière de fluides réfrigérants inflammables (série EN 60335).

Les interventions d'installation, de maintenance et de réparation ne doivent être effectuées que par le personnel autorisé, qualifié, capable de travailler sur des systèmes avec réfrigérants inflammables.



## **FÜR KÄLTEMITTEL MIT KOHLENWASSERSTOFFEN GEEIGNETE PRODUKTE**

Die in diesem Katalog vorgestellten Produkte für Kältemittel mit Kohlenwasserstoffen können mit den folgenden Kühlf Fluiden eingesetzt werden: R290 (Propan), R600 (Butan), R600a (Isobutan) und R1270 (Propylen).

Diese Kältemittel werden gemäß der Norm EN 378-1 zur Sicherheitsgruppe A3 gehörige Flüssigkeiten eingeordnet: 2016.

Die obigen Produkte dürfen ausschließlich in Kühlsystemen verwendet werden, die den geltenden Bestimmungen für entzündliche Kühlfuide (Serie EN 60335) erfüllen.

Installations-, Wartungs- und Reparaturarbeiten dürfen nur von befugtem und zum Arbeiten an Anlagen mit entzündlichen Kältemitteln qualifiziertem Personal ausgeführt werden.

TABELLA 1 - Corrispondenza tra i codici Castel e le dimensioni in pollici

TABLE 1 - Equivalence between Castel codes and dimensions in inches

TABLEAU 1 - Correspondance entre les codes Castel et les dimensions en pouces

TABELLE 1 - Beziehung zwischen den Codes von Castel und den Abmessungen in Zoll

Codifica Castel	Dimensione
Castel code	Dimension
Code Castel	Dimension
Code von Castel	Abmessung
	[in]
.../1	1/8"
.../2	1/4"
.../2,5	5/16"
.../3	3/8"
.../4	1/2"
.../5	5/8"
.../6	3/4"
.../7	7/8"
.../8	1"
.../9	1" 1/8
.../11	1" 3/8
.../13	1" 5/8
.../17	2" 1/8
.../21	2" 5/8
.../24	3"
.../25	3" 1/8
.../28	3" 1/2
.../29	3" 5/8
.../33	4" 1/8
.../34	4" 1/4

Esempio: 1098/7  
- valvola a solenoide con attacchi a saldare con  $\varnothing = 7/8"$

F.e.: 1098/7 - solenoid valve with solder connection with  $\varnothing = 7/8"$

Exemple: 1098/7 - vanne solénoïde avec embouts à souder avec  $\varnothing = 7/8"$

Beispiel: 1098/7 - Solenoidventil mit Schweißanschlüssen mit  $\varnothing = 7/8"$

TABELLA 2 - Corrispondenza tra i codici Castel e le dimensioni in millimetri

TABLE 2 - Equivalence between Castel codes and dimensions in millimeters

TABLEAU 2 - Correspondance entre les codes Castel et les dimensions en millimètres

TABELLE 2 - Beziehung zwischen den Codes von Castel und den Abmessungen in Millimetern

Codifica Castel	Dimensione
Castel code	Dimension
Code Castel	Dimension
Code von Castel	Abmessung
	[mm]
.../M6	6
.../M10	10
.../M12	12
.../M15	15
.../M18	18
.../M22	22
.../M28	28
.../M42	42
.../M64	64

Esempio: 4411/M42A - filtro disidratatore con cartuccia solida anti acida sostituibile con attacchi a saldare con  $\varnothing = 42$  mm

F.e.: 4411/M42A - filter drier with replaceable anti-acid solid core with solder connection with  $\varnothing = 42$  mm

Exemple: 4411/M42A - filtre déshydrateur avec cartouche solide anti-acide remplaçable avec embouts à souder avec  $\varnothing = 42$  mm

Beispiel: 4411/M42A - Dehydrationsfilter mit säurebeständigem, festem, austauschbarem Einsatz mit Schweißanschlüssen mit  $\varnothing = 42$  mm

TABELLA 3 - Attacco FLARE

TABLE 3 - Flare Connection

TABLEAU 3 - Raccord FLARE

TABELLE 3 - Anschluss FLARE

Codifica Castel	FLARE	Adattoper tubo in rame	Filettatura
Castel code		Suitable for copper tube	Thread
Code Castel		Adéquat pour tuyau en cuivre	Filetage
Code von Castel		Adapter für Kupferrohr	Gewinde
.../2	1/4"	$\varnothing 1/4"$	7/16" - 20 UNF
.../2,5	5/16"	$\varnothing 5/16"$	1/2" - 20 UNF
.../3	3/8"	$\varnothing 3/8"$	5/8" - 18 UNF
.../4	1/2"	$\varnothing 1/2"$	3/4" - 16 UNF
.../5	5/8"	$\varnothing 5/8"$	7/8" - 14 UNF
.../6	3/4"	$\varnothing 3/4"$	1.1/16" - 14 UNS
.../7	7/8"	$\varnothing 7/8"$	1.1/4" - 12 UNF
.../8	1"	$\varnothing 1"$	1.3/8" - 12 UNF

TABELLA 4 - Attacco FPT

TABLE 4 - FPT Connection

TABLEAU 4 - Raccord FPT

TABELLE 4 - Anschluss FPT

Codifica Castel	Filettatura
Castel code	Thread
Code Castel	Filetage
Code von Castel	Gewinde
.../01	G 1/8"
.../02	G 1/4"
.../03	G 3/8"
.../04	G 1/2"
.../06	G 3/4"
.../08	G 1"
.../010	G 1.1/4"
.../012	G 1.1/2"
.../016	G 2"
.../020	G 2.1/2"
.../024	G 3"



**INDICE**  
**TABLE OF CONTENTS**  
**CONTENU**  
**INHALT**

---



# GO GREEN

R 744 • NATURAL REFRIGERANT

**PRODOTTI PER REFRIGERANTE R744**  
**PRODUCTS FOR R744 REFRIGERANT**  
**PRODUITS POUR RÉFRIGÉRANT R744**  
**PRODUKTE FÜR KÄLTEMITTEL R744**

- 30** VALVOLE D'ESPANSIONE A SOLENOIDE CON ORIFIZIO INTERCAMBIABILE  
SOLENOID EXPANSION VALVES WITH INTERCHANGEABLE ORIFICE  
DÉTENDEURS À COMMANDE ÉLECTRIQUES AVEC ENSEMBLE  
ORICE INTERCHANGEABLE  
ELEKTRISCH BETRIEBENE EXPANSIONSVENTILE MIT AUSTAUSCHBARER DÜSENEINSATZ
- 31** VALVOLE SOLENOIDI N.C  
N.C. SOLENOID VALVES  
ELECTROVANNES N.F.  
N.G. MAGNETVENTILE
- 33** BOBINE E CONNETTORI  
COILS AND CONNECTORS  
BOBINES ET CONNECTEURS  
SPULEN UND STECKER
- 35** DISPOSITIVI DI SICUREZZA  
SAFETY DEVICES  
DISPOSITIVES DE SECURITE  
SICHERHEITSVORRICHTUNGEN
- 38** VALVOLE DI RITEGNO  
CHECK VALVES  
CLAPETS ANTI-RETOUR  
RÜCKSCHLAGVENTILE
- 41** REGOLATORI DI PRESSIONE  
PRESSURE REGULATORS  
RÉGULATEURS DE PRESSION  
DRUCKREGLERS
- 42** INDICATORI  
SIGHT GLASSES  
VOYANTS  
SCHAUGLÄSER
- 44** FILTRI DISIDRATATORI  
FILTER DRIERS  
FILTRES DÉSHYDRATEURS  
FILTERTROCKNER
- 47** FILTRI MECCANICI  
MECHANICAL FILTERS  
FILTRES MÉCANIQUE  
MECHANISCHE / SAUGLEITUNGFILTER
- 50** SISTEMA DI CONTROLLO DELL'OLIO  
OIL CONTROL SYSTEM  
SYSTEME DE REGULATION D'HUILE  
ÖLSTANDSREGULIERSYSTEM
- 53** RUBINETTI VARI  
VALVES  
VANNES  
VENTILE
- 54** RUBINETTI A SFERA  
BALL VALVES  
VANNES A BOISSEAU SPHÉRIQUE  
KUGELVENTILE
- 58** RUBINETTI A 3-VIE  
3-WAY VALVES  
VANNES À 3 VOIES  
3-WEGE-VENTILE
- 62** SERVOMOTORI  
ACTUATORS  
SERVOMOTEUR  
STELLANTRIEB
- 65** ANTIVIBRANTI  
VIBRATION ISOLATORS  
ÉLIMINATEURS DE VIBRATIONS  
SCHWINGUNGSDÄMPFER

PRODOTTI PER REFRIGERANTI DI GRUPPO A1, A2L, A3, SECONDO ASHRAE STANDARD 34-2019  
PRODUCTS FOR REFRIGERANTS OF GROUPS A1, A2L, A3, ACCORDING TO ASHRAE STANDARD 34-2019  
PRODUITS POUR RÉFRIGÉRANTS DES GROUPES A1, A2L, A3, CONFORMÉMENT À LA NORME ASHRAE 34-2019  
PRODUKTE FÜR KÜHLMITTEL DER GRUPPEN A1, A2L, A3, NACH ASHRAE STANDARD 34-2019

- 68 VALVOLE D'ESPANSIONE A SOLENOIDE CON ORIFIZIO  
INTERCAMBIABILE  
SOLENOID EXPANSION VALVES WITH INTERCHANGEABLE  
ORIFICE  
DÉTENDEURS À COMMANDE ÉLECTRIQUES AVEC ENSEMBLE  
ORICE INTERCHANGEABLE  
ELEKTRISCH BETRIEBENE EXPANSIONSVENTILE MIT  
AUSTAUSCHBARER DÜSENEINSATZ
- 72 VALVOLE D'ESPANSIONE ELETTRONICHE  
ELECTRONIC EXPANSION VALVES  
DÉTENDEURS ÉLECTRONIQUES  
ELEKTRONISCHE EXPANSIONSVENTILE
- 74 VALVOLE SOLENOIDI N.C.  
N.C. SOLENOID VALVES  
ELECTROVANNES N.F.  
N.G. MAGNETVENTILE
- 80 VALVOLE SOLENOIDI N.A.  
N.O. SOLENOID VALVES  
ELECTROVANNES N.O.  
N.O. MAGNETVENTILE
- 82 BOBINE E CONNETTORI  
COILS AND CONNECTORS  
BOBINES ET CONNECTEURS  
SPULEN UND STECKER
- 84 SISTEMA "SMART CONNECTOR"  
"SMART CONNECTOR" SYSTEM  
SYSTÈME "SMART CONNECTOR"  
"SMART CONNECTOR" SYSTEM
- 85 DISPOSITIVI DI SICUREZZA  
SAFETY DEVICES  
DISPOSITIVES DE SECURITE  
SICHERHEITSVORRICHTUNGEN
- 88 VALVOLE DI RITEGNO  
CHECK VALVES  
CLAPETS ANTI-RETOUR  
RÜCKSCHLAGVENTILE
- 91 REGOLATORI DI PRESSIONE  
PRESSURE REGULATORS  
RÉGULATEURS DE PRESSION  
DRUCKREGLERS
- 92 INDICATORI  
SIGHT GLASSES  
VOYANTS  
SCHAUGLÄSER
- 95 FILTRI DISIDRATATORI  
FILTER DRIERS  
FILTRES DÉSHYDRATEURS  
FILTERTROCKNER
- 106 FILTRI MECCANICI  
MECHANICAL FILTERS  
FILTRES MÉCANIQUE  
MECHANISCHE / SAUGLEITUNGFILTER
- 110 SISTEMA DI CONTROLLO DELL'OLIO  
OIL CONTROL SYSTEM  
SYSTEME DE REGULATION D'HUILE  
ÖLSTANDSREGULIERSYSTEM
- 112 RUBINETTI VARI  
VALVES  
VANNES  
VENTILE
- 113 RUBINETTI A SFERA  
BALL VALVES  
VANNES A BOISSEAU SPHÉRIQUE  
KUGELVENTILE
- 114 RUBINETTI A 3-VIE  
3-WAY VALVES  
VANNES À 3 VOIES  
3-WEGE-VENTILE
- 116 SERVOMOTORI  
ACTUATORS  
SERVOMOTEUR  
STELLANTRIEB
- 118 ANTIVIBRANTI  
VIBRATION ISOLATORS  
ÉLIMINATEURS DE VIBRATIONS  
SCHWINGUNGSDÄMPFER



# CLASSIC

PRODOTTI PER REFRIGERANTI DI GRUPPO A1, SECONDO ASHRAE STANDARD 34-2019  
PRODUCTS FOR REFRIGERANTS OF GROUPS A1, ACCORDING TO ASHRAE STANDARD 34-2019  
PRODUITS POUR RÉFRIGÉRANTS DES GROUPES A1, CONFORMÉMENT À LA NORME ASHRAE 34-2019  
PRODUKTE FÜR KÜHLMITTEL DER GRUPPEN A1, NACH ASHRAE STANDARD 34-2019

- |   |   |
|---|---|
| <p><b>122</b> VALVOLE D'ESPANSIONE A SOLENOIDE CON ORIFIZIO INTERCAMBIABILE<br/>SOLENOID EXPANSION VALVES WITH INTERCHANGEABLE ORIFICE<br/>DÉTENDEURS À COMMANDE ÉLECTRIQUES AVEC ENSEMBLE ORICE INTERCHANGEABLE<br/>ELEKTRISCH BETRIEBENE EXPANSIONSVENTILE MIT AUSTAUSCHBARER DÜSENEINSATZ</p> <p><b>125</b> SISTEMA "SMART CONNECTOR"<br/>"SMART CONNECTOR" SYSTEM<br/>SYSTÈME "SMART CONNECTOR"<br/>"SMART CONNECTOR" SYSTEM</p> <p><b>126</b> VALVOLE SOLENOIDI N.C.<br/>N.C. SOLENOID VALVES<br/>ELECTROVANNES N.F.<br/>N.G. MAGNETVENTILE</p> <p><b>132</b> VALVOLE SOLENOIDI N.A.<br/>N.O. SOLENOID VALVES<br/>ELECTROVANNES N.O.<br/>N.O. MAGNETVENTILE</p> <p><b>135</b> BOBINE E CONNETTORI<br/>COILS AND CONNECTORS<br/>BOBINES ET CONNECTEURS<br/>SPULEN UND STECKER</p> <p><b>137</b> DISPOSITIVI DI SICUREZZA<br/>SAFETY DEVICES<br/>DISPOSITIVES DE SECURITE<br/>SICHERHEITSVORRICHTUNGEN</p> <p><b>141</b> VALVOLE DI RITEGNO<br/>CHECK VALVES<br/>CLAPETS ANTI-RETOUR<br/>RÜCKSCHLAGVENTILE</p> <p><b>145</b> REGOLATORI DI PRESSIONE<br/>PRESSURE REGULATORS<br/>RÉGULATEURS DE PRESSION<br/>DRUCKREGLERS</p> <p><b>148</b> INDICATORI<br/>SIGHT GLASSES<br/>VOYANTS<br/>SCHAUGLÄSER</p> | <p><b>151</b> FILTRI DISIDRATATORI<br/>FILTER DRIERS<br/>FILTRES DÉSHYDRATEURS<br/>FILTERTROCKNER</p> <p><b>161</b> FILTRI MECCANICI<br/>MECHANICAL FILTERS<br/>FILTRES MÉCANIQUE<br/>MECHANISCHE / SAUGLEITUNGFILTER</p> <p><b>164</b> SISTEMA DI CONTROLLO DELL'OLIO<br/>OIL CONTROL SYSTEM<br/>SYSTEME DE REGULATION D'HUILE<br/>ÖLSTANDSREGULIERSYSTEM</p> <p><b>165</b> RUBINETTI VARI<br/>VALVES<br/>VANNES<br/>VENTILE</p> <p><b>169</b> RUBINETTI A SFERA<br/>BALL VALVES<br/>VANNES A BOISSEAU SPHÉRIQUE<br/>KUGELVENTILE</p> <p><b>171</b> RUBINETTI A 3-VIE<br/>3-WAY VALVES<br/>VANNES À 3 VOIES<br/>3-WEGE-VENTILE</p> <p><b>173</b> SERVOMOTORI<br/>ACTUATORS<br/>SERVOMOTEUR<br/>STELLANTRIEB</p> <p><b>176</b> ANTIVIBRANTI<br/>VIBRATION ISOLATORS<br/>ÉLIMINATEURS DE VIBRATIONS<br/>SCHWINGUNGSDÄMPFER</p> |
|---|---|

## FITTINGS

PRODOTTI PER REFRIGERANTI DI GRUPPO A1, A2L, A3 & R744 SECONDO ASHRAE STANDARD 34-2019  
PRODUCTS FOR REFRIGERANTS OF GROUPS A1, A2L, A3 & R744, ACCORDING TO ASHRAE STANDARD 34-2019  
PRODUITS POUR RÉFRIGÉRANTS DES GROUPES A1, A2L, A3 & R744, CONFORMÉMENT À LA NORME ASHRAE 34-2019  
PRODUKTE FÜR KÜHLMITTEL DER GRUPPEN A1, A2L, A3 & R744, NACH ASHRAE STANDARD 34-2019

- 181** RACCORDI D'OTTONE FILETTATI  
THREADED BRASS FITTINGS  
RACCORDS FILETES EN LAITON  
MISSINGFITTINGE
- 189** ATTACCHI DI CARICA  
ACCESS FITTINGS  
RACCORD D'INTERVENTION  
SCHRADERVENTILE

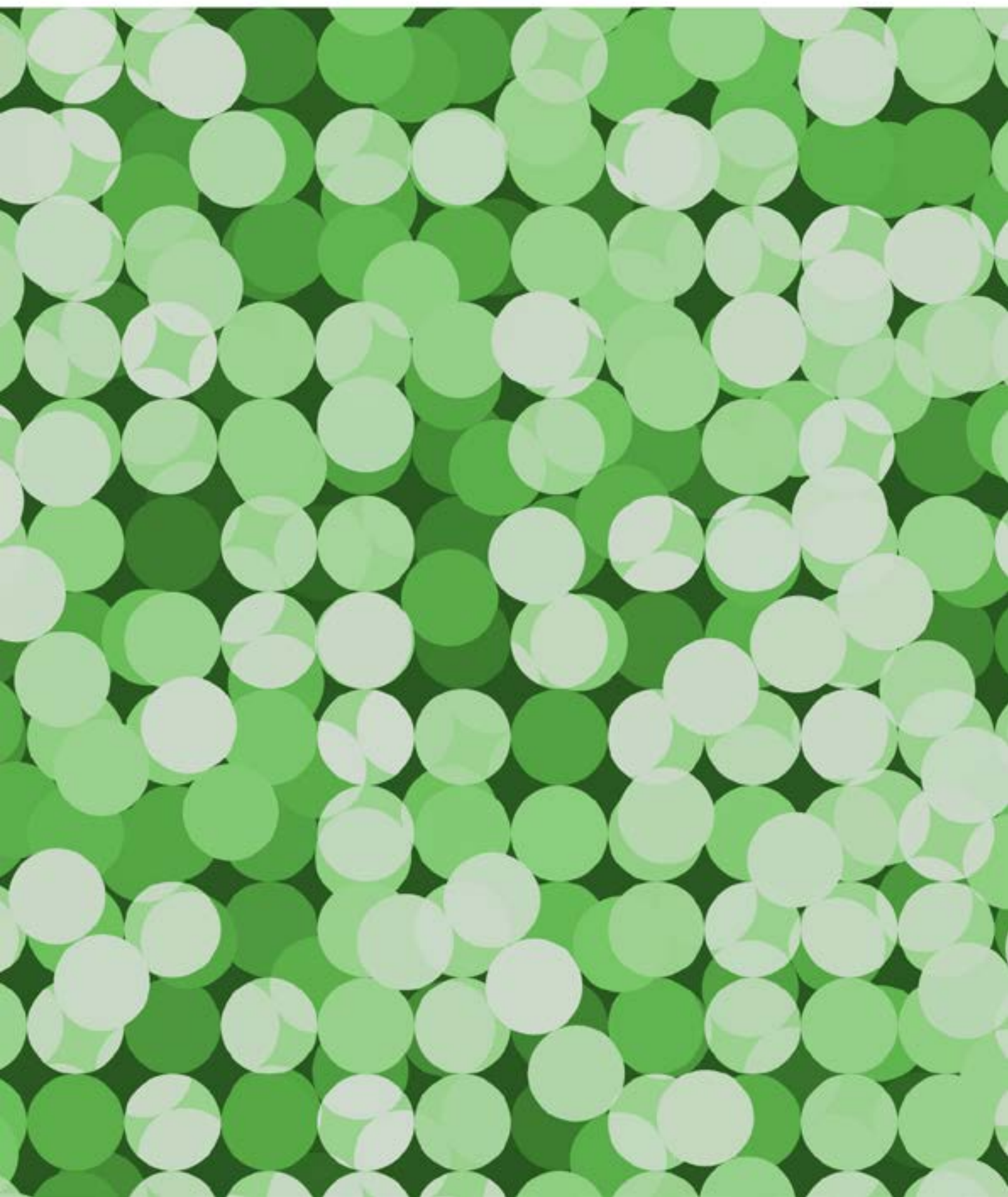



**GO GREEN**

R744 • NATURAL REFRIGERANT

**REFRIGERANTE CO<sub>2</sub> (R744)**  
**CO<sub>2</sub> REFRIGERANTS (R744)**  
**FLUIDE FRIGORIGENE CO<sub>2</sub> (R744)**  
**CO<sub>2</sub> KALTEMITTEL (R744)**

 **Castel**  
Italian technology



**VALVOLE D'ESPANSIONE A SOLENOIDE CON ORIFIZIO INTERCAMBIABILE**  
**SOLENOID EXPANSION VALVES WITH INTERCHANGEABLE ORIFICE**  
**DÉTENDEURS À COMMANDE ÉLECTRIQUES AVEC ENSEMBLE ORICE INTERCHANGEABLE**  
**ELEKTRISCHE EXPANSIONSVENTILE MIT AUSTAUSCHBAREM DÜSENEINSATZ**



Disegno Drawing Dessin Zeichnung	N° catalogo Part number N° Catalogue Katalog Nr	Tipo orificio Orifice type Type d'orifice Düseinsatz Typ	Attacchi Connections Raccords Anschlüsse				Kv [m <sup>3</sup> /h]	PS [bar]	TS [°C]		Confezione n° pz Package pcs. Emballage Verpackung
			In		Out				Min	Max	
			Ø [in.]	Ø [mm]	Ø [in.]	Ø [mm]					
	2028E/3S01	01	3/8"	-	1/2"	-	0,010	90	-50	+100	17
	2028E/M10S01		-	10	-	12					
	2028E/3S02	02	3/8"	-	1/2"	-	0,017				
	2028E/M10S02		-	10	-	12					
	2028E/3S03	03	3/8"	-	1/2"	-	0,023				
	2028E/M10S03		-	10	-	12					
	2028E/3S04	04	3/8"	-	1/2"	-	0,043				
	2028E/M10S04		-	10	-	12					
	2028E/3S05	05	3/8"	-	1/2"	-	0,065				
	2028E/M10S05		-	10	-	12					
	2028E/3S06	06	3/8"	-	1/2"	-	0,113				
	2028E/M10S06		-	10	-	12					
	2028E/4S07	07	1/2"	-	5/8"	-	0,200				
	2028E/M12S07		-	12	-	16					
	2028E/4S08	08	1/2"	-	5/8"	-	0,230				
	2028E/M12S08		-	12	-	16					
2028E/4S09	09	1/2"	-	5/8"	-	0,250					
2028E/M12S09		-	12	-	16						

**GRUPPI ORIFICI**  
**ORIFICE ASSEMBLIES**  
**ENSEMBLES ORIFICE**  
**DÜSENEINSATZ**



Disegno Drawing Dessin Zeichnung	N° catalogo Part number N° Catalogue Katalog Nr	Tipo orificio Orifice type Type d'orifice Düseinsatz Typ	Potenzialità nominali (1) Rated capacity (1) Capacités nominales (1) Nennleistungen (1)	Confezione n° pz Package pcs. Emballage Verpackung
			[kW]	
			R744	
	9150E/R63	01	2,3	10
	9150E/R64	02	4,1	
	9150E/R65	03	5,4	
	9150E/R66	04	8,2	
	9150E/R67	05	14,5	
	9150E/R68	06	20,2	
	9150E/R69	07	32,1	
	9150E/R78	08	38,1	
	9150E/R79	09	43,4	

(1) Le potenzialità nominali sono riferite a:  
 - Temperatura d'evaporazione T<sub>evap</sub> = -25 °C  
 - Temperatura di condensazione T<sub>cond</sub> = +0 °C  
 - Temperatura del liquido all'ingresso della valvola T<sub>liq</sub> = -4 °C

(1) Rated capacities are based on:  
 - Evaporating temperature T<sub>evap</sub> = -25 °C  
 - Condensing temperature T<sub>cond</sub> = +0 °C  
 - Refrigerant liquid temperature ahead of valve T<sub>liq</sub> = -4 °C

(1) Les capacités nominales se basent sur :  
 - Température d'évaporation T<sub>evap</sub> = -25 °C  
 - Température de condensation T<sub>cond</sub> = +0 °C  
 - Température du liquide frigorigène en amont du détendeur T<sub>liq</sub> = -4 °C

(1) Nennleistungen basieren auf:  
 - Verdampfungstemperatur T<sub>verd</sub> = -25 °C  
 - Kondensationstemperatur T<sub>kond</sub> = +0 °C  
 - Temperatur des flüssigen Kältemittels vor dem Ventil T<sub>flü</sub> = -4 °C

**VALVOLE SOLENOIDE, ATTACCHI ODS DI RAME, SENZA BOBINA**  
**SOLENOID VALVES, COPPER ODS CONNECTIONS, WITHOUT COILS**  
**VANNES ELECTROMAGNETIQUES, CUIVRE ODS RACCORDS, SANS BOBINE**  
**MAGNETVENTILE, KUPFER ODS ANSCHLÜSSE, OHNE SPULE**

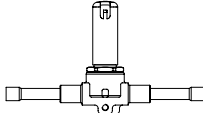
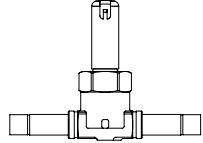
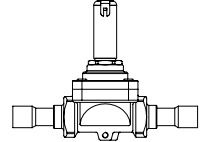
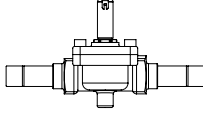
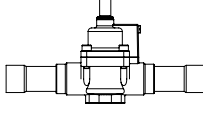
Principio di funzionamento Operating principle Principe de fonctionnement Funtionsprinzip	Disegno Drawing Dessin Zeichnung	N° Catalogo Part Number N° Catalogue Katalog Nr	Tipo Bobina Coil Type Type bobine Spulentyp	Attacchi ODS Ø Connections ODS Ø Raccords ODS Ø Anschlüsse ODS Ø		Kv [m³/h]	PS [bar]	TS [°C]		Confezione n° pz Package Pcs. Emballage Verpackung
			(1)	[in.]	[mm]			Min	Max	
Azione diretta Direct acting Action directe Direkte Aktion		1028EL/2S	HF3 (HM3)	1/4"	-	0,15	60	-40	+130	24
		1028EL/2S.E		1/4"	-	0,23				
		1028EL/3S		3/8"	-					
		1028EL/M10S		-	10					
Servocomando a pistone Piston pilot operated Servocommande à piston Kolbenantrieb		1038EL/3S	HF3 (HM3)	3/8"	-	1,0	60	-40	+130	24
		1038EL/M10S		-	10					
		1038EL/M12S		-	12					
		1038EL/4S		1/2"	-					
		1048EL/M12S	HF3 (HM3)	-	12	2,4	60	-40	+130	14
		1048EL/4S		1/2"	-					
		1048EL/5S		5/8"	16	3,0				
		1058EL/5S	HF3 (HM3)	5/8"	16	3,8	60	-40	+130	14
		1058EL/6S		3/4"	-	4,8				
		1058EL/7S		7/8"	22	5,7				
		1098EL/9S	HF3 (HM3)	1.1/8"	-	10	60	-40	+130	1
		1078EL/11S		1.3/8"	35	16	60	-40	+130	1
		1078EL/13S		1.5/8"	-	25	60	-40	+130	1

(1) : bobine che possono essere montate sulle valvole

(1) : coils that can be fit the valves

(1) : bobines qui peuvent être montés sur les vannes

(1) : Spulen, die an den Ventilen montiert werden kann

**VALVOLE SOLENOIDE ALTA PRESSIONE PER GAS CALDO E OLIO  
HIGH PRESSURE SOLENOID VALVES FOR HOT GAS AND OIL  
ELECTROVANNE HAUTE PRESSION POUR GAS CHAUD ET HUILE  
HOCHDRUCK-MAGNETVENTILE FÜR HEISSGAS UND ÖLLEITUNG**

Principio di funzionamento Operating principle Principe de fonctionnement Funtionsprinzip	Disegno Drawing Dessin Zeichnung	N° Catalogo Part Number N° Catalogue Katalog Nr	Tipo Bobina Coil Type Type bobine Spulentyp	Attacchi ODS Ø Connections ODS Ø Raccords ODS Ø Anschlüsse ODS Ø		Kv [m³/h]	PS [bar]	TS [°C]		Confezione n° pz Package Pcs. Emballage Verpackung
			(1)	[in.]	[mm]			Min	Max	

Con attacchi ods di rame rinforzato (k65) / with reinforced copper ods connections (k65) / avec connexion cuivre ods renforcées (k65) / Mit lötlanschluss in kupferausführung (k65)

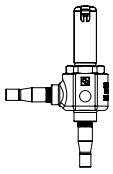
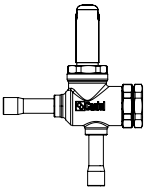
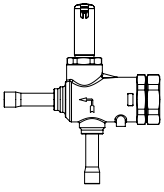
Azione diretta Direct acting Action directe Direkte aktion		NEW	1417E/2S05	HF3	1/4"	-	0,065	130	-40 (2)	+130 (2)	14
		NEW	1417E/3S05		3/8"	-					
Servocomando a pistone Piston pilot operated Servocommande à piston Kolbenantrieb		NEW	1427E/2S020		1/4"	-	0,15				
		NEW	1427E/3S020		3/8"	-					
		NEW	1427E/2S030		1/4"	-	0,32				
		NEW	1427E/3S030		3/8"	-					
		NEW	1437E/3S050 (3)		3/8"	-	0,80				
		NEW	1437E/4S050 (3)		1/2"	-					
		NEW	1437E/3S070 (3)		3/8"	-	1,10				
		NEW	1437E/4S070 (3)		1/2"	-					

Con attacchi d'acciaio inossidabile / with stainless steel connections / avec connexion en acier inoxydable / mit anschlüssen aus rostfreiem stahl

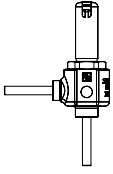
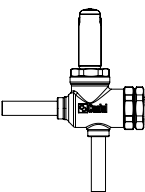
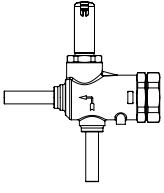
Azione diretta Direct acting Action directe Direkte aktion		NEW	1418E/M6S05	HF3	-	6	0,065	140	-40 (2)	+130 (2)	14
		NEW	1418E/M10S05		-	10					
Servocomando a pistone Piston pilot operated Servocommande à piston Kolbenantrieb		NEW	1428E/M6S020		-	6	0,15				
		NEW	1428E/M10S020		-	10					
		NEW	1428E/M6S030		-	6	0,32				
		NEW	1428E/M10S030		-	10					
		NEW	1438E/M10S050 (3)		-	10	0,80				
		NEW	1438E/M12S050 (3)		-	12					
		NEW	1438E/M10S070 (3)		-	10	1,10				
		NEW	1438E/M12S070 (3)		-	12					

(1) : bobine che possono essere montate sulle valvole  
(2) : per impiego su linea dell'olio TS = -10 /+70 °C  
(3) : per impiego su linea dell'olio contattate CASTEL

(1) : coils that can fit the valves  
(2) : for use in the oil line TS = -10 /+70 °C  
(3) : for use in the oil line please contact CASTEL

(1) : bobines qui peuvent être montés sur les vannes  
(2) : pour utilisation sur la conduite d'huile TS = -10 / + 70 ° C  
(3) : pour utilisation sur la conduite d'huile contactez CASTEL

(1) : Spulen, die an den Ventilen montiert werden kann  
(2) : für den Einsatz in der Ölleitung TS = -10 / + 70 ° C  
(3) : Zur Verwendung an der Ölleitung wenden Sie sich an CASTEL

**BOBINE  
COILS  
BOBINES  
SPULEN**

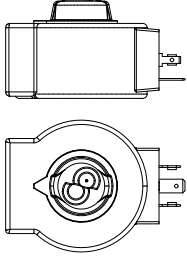
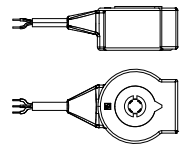
Disegno Drawing Dessin Zeichnung	Tipo Bobina Coil Type Type bobine Spulentyp	N° catalogo Part number N° catalogue Katalog Nr.	Tensione Voltage Tension Spannung [V]	Frequenza Frequency Fréquence Frequenz [Hz]	Potenza Power Puissance Leistung [W]	Lunghezza cavo Cable length Longueur du câble Kabellänge [m]	Confezione n° pz Package pcs Emballage Verpackung
	HF3	9320/RA6	220/230	50/60	12	-	18
		9320/RD1	12 D.C.	-	20		
		9320/RD2	24 D.C.	-			
	CM3 (1)	9121/RA6	220/230	50/60	12	7	1

(1)  
bobina dotata di ricambio G9151/R14

(1)  
coil with spare part G9151/R14

(1)  
Bobine avec remplacement G9151/R14

(1)  
Spule mit Ersatz G9151/R14 ausgestattet

**CONNETTORI  
CONNECTORS  
CONNECTEURS  
STECKER**

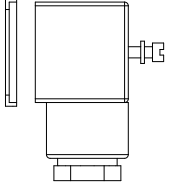
Disegno Drawing Dessin Zeichnung	N° catalogo Part number N° catalogue Katalog Nr.	Grado di protezione Degree of protection Degré de protection Schutzklasse	Lunghezza cavo Cable length Longueur du câble Kabellänge	Confezione n° pz Package pcs Emballage Verpackung
	9150/R02	IP 65	-	240
	9900/X66		1	50

**SISTEMA "SMART CONNECTOR"**  
**"SMART CONNECTOR" SYSTEM**  
**SYSTÈME "SMART CONNECTOR"**  
**"SMART CONNECTOR" SYSTEM**

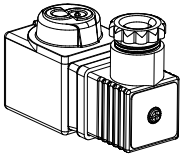
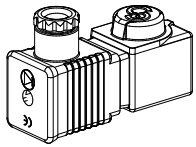

Disegno Drawing Dessin Zeichnung	N° catalogo Part number N° catalogue Katalog Nr.	Tensione Voltage Tension Spannung [V]	Frequenza Frequency Fréquence Frequenz [Hz]	T boost [msec]	Potenza Power Puissance Leistung		Confezione n° pz Package pcs Emballage Verpackung
					esercizio working travail Arbeit [W]	avvio start début Anfang [W]	
	9910/RD1	12 D.C.	-	130	3	50	12
	9910/RD2	24 D.C.	-	130	5	50	
	9910/RA2	24	50/60	200	7	50	
	9910/RA6	220	50/60	200	7	50	
	9910/RA7	240	50/60	200	7	50	

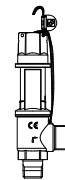
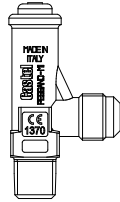
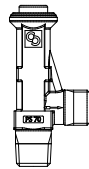
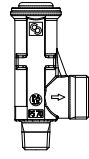
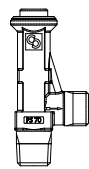
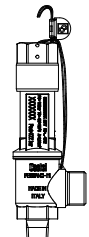

**VALVOLE DI SICUREZZA**  
**SAFETY VALVES**  
**SOUPAPES DE SURETE**  
**SICHERHEITSENTILE**

Disegno Drawing Dessin Zeichnung	N° catalogo Part number N° Catalogue Katalog Nr	Attacchi Connections Raccords Anschlüsse		Sezione orificio Orifice section Section orifice Öffnungs- querschnitt [mm <sup>2</sup> ]	Coefficiente di scarico Kd Discharge coefficient Kd Coefficient d' écoulement Kd Ausströmungsfaktor Kd	Campo taratura Set pressure range Champ de tarage Einstellbereich [bar]	PS [bar]	TS [°C]		Confezione n° pz Package pcs Emballage Verpackung
		IN	OUT					min	max	
	3030/88C	1" NPT	1.1/4" G	298	0,83	8 → 50	55	-50	+150	8
	3030/66C	3/4" NPT	3/4" G	113	0,9					15
	3030/44C	1/2" NPT	3/4" G	113	0,9					15
	3030/44G (1)	1/2" G	3/4" G	113	0,9					15
	3060/46C	1/2" NPT	3/4" G	78,5	0,93	9 → 50	55	-50	+120	45
	3060/36C	3/8" NPT	3/4" G	78,5	0,92					
	3060/45C	1/2" NPT	5/8" SAE	70,9	0,45					
	3060/34C	3/8" NPT	1/2" SAE	38,5	0,69					
	3060/33C	3/8" NPT	3/8" SAE	38,5	0,63					
	3060/24C	1/4" NPT	1/2" SAE	38,5	0,69					
	3060/23C	1/4" NPT	3/8" SAE	38,5	0,63					
	3061/2C	1/4" NPT	3/8" G	44,2	0,89	11 → 60	70	-50	+150	18
	3061/3C	3/8" NPT	1/2" G							
	3061/4C	1/2" NPT	1/2" G							
	3065/4C	1/2" NPT	1" G	132,7	0,87	11 → 60	70	-50	+150	24
	3065/6C	3/4" NPT	1" G							
	<b>NEW</b> 3061E/2C	1/4" NPT	3/8" G	15,9	0,90	60 → 150	165	-50	+150	18
	<b>NEW</b> 3061E/3C	3/8" NPT	1/2" G							
	<b>NEW</b> 3061E/4C	1/2" NPT	1/2" G							
	3030E/36C	3/8" NPT	3/4" G	38,5	0,97	60 → 150	165	-50	+150	15
	3030E/46C	1/2" NPT	3/4" G							
	3030E/410C	1/2" NPT	1.1/4" G	95,0	0,91					8
	3030E/610C	3/4" NPT	1.1/4" G							

(1)  
Prodotto a richiesta.

(1)  
Product on request.

(1)  
Produit sur demande.

(1)  
Produkt auf Anfrage.

**RUBINETTI DI SCAMBIO  
CHANGEOVER VALVES  
VANNE D'ECHANGE  
WECHSELHAHN**

Disegno Drawing Dessin Zeichnung	N° Catalogo Part number N° Catalogue Katalog Nr	Raccordi forniti Supplied connections raccords fournis mitgelieferte Anschlüsse	Attacchi Connections Raccords Anschlüsse		Kv [m³/h]	PS [bar]	TS [°C]		Confezione n° pz Package pcs Emballage Verpackung
			IN	OUT			Min	Max	
	3032E/33	3039/3	3/8" NPT	3/8" NPT	2,5	150			14
	3032E/44	3039/4	1/2" NPT	1/2" NPT	3,3				
	3032E/64	-	3/4" NPT	1/2" NPT	9	120	-40	+150	15
	3032E/66	-	3/4" NPT	3/4" NPT	9				
	3032E/64L (1)	-	3/4" NPT	1/2" NPT	9				
	3032E/66L (2)	-	3/4" NPT	3/4" NPT	9				1
	3032E/88	-	1" NPT	1" NPT	14,5				
	3032E/108	-	1.1/4" NPT	1" NPT	20				

(1): Utilizzare con valvola 3030E/410C  
(2): Utilizzare con valvola 3030E/610C

(1): Use with 3030E/410C valve  
(2): Use with 3030E/610C valve

(1): À utiliser avec la vanne 3030E/410C  
(2): À utiliser avec la vanne 3030E/610C

(1): Mit Ventil 3030E/410C verwenden  
(2): Mit Ventil 3030E/610C verwenden

**COPPIE DI ATTACCHI PER RUBINETTI DI SCAMBIO  
COUPLE OF CONNECTIONS FOR CHANGEOVER VALVES  
COUPLE DE CONNECTIONS POUR VANNE D'ECHANGE  
LÖTFITTING-PAR FÜR WECHSELHAHN**

Disegno Drawing Dessin Zeichnung	N° catalogo Part number N° catalogue Katalog Nr.	Attacco Connection Raccord Anschlus	Materiali Materials Matériaux Werkstoffe	Confezione n° pz Package pcs Emballage Verpackung
	3039/3	3/8" NPT-F	Ferro zincato Zinc plated steel Acier galvanisé Stahl verzinkt	25
	3039/4	1/2" NPT-F		
	3039/30T	3/8" NPT-F	Acciao inox/Ottone Stainless steel/Brass Inox / Laiton Edelstahl / Messing	
	3039/40T	1/2" NPT-F		

**RUBINETTI DI INTERCETTAZIONE A SFERA**  
**BALL SHUT OFF VALVES**  
**VANNE D'INTERCEPTION A BOISSEAU SPHERIQUE**  
**KUGELABSPERRHAHN**

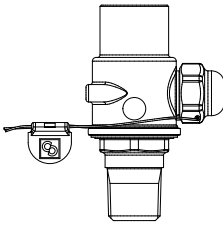
Disegno Drawing Dessin Zeichnung	N° Catalogo Part Number N° Catalogue Katalog Nr	Attacchi Connections Raccords Anschlüsse		Kv [m³/h]	PS [bar]	TS [°C]		Confezione n° pz Package pcs Emballage Verpackung
		NPT				Min	Max	
	3064E/22	1/4"		2,5	150	-40	+150	20
	3064E/33	3/8"		5				
	3064E/44	1/2"		10				
	3064E/88	1"		20	80			14

**RACCORDI**  
**UNIONS**  
**RACCORDS**  
**ANSCHLÜSSE**

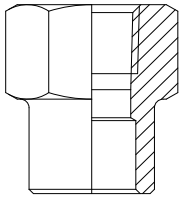
Disegno Drawing Dessin Zeichnung	N° Catalogo Part Number N° Catalogue Katalog Nr	Attacchi Connections Raccords Anschlüsse		PS [bar]	Confezione n° pz Package pcs Emballage Verpackung
		NPT	ODS Ø [mm]		
	3035/2	1/4"	12	150	100
	3035/3	3/8"	18		
	3035/4	1/2"	22		
	3035/6	3/4"	28	120	24
	3035/8	1"	35		
	3035/10	1.1/4"	42		

**VALVOLE DI RITEGNO IN LINEA - OMOLOGATE DA UNDERWRITERS LABORATORIES INC.  
 STRAIGHT CHECK VALVES - APPROVED BY UNDERWRITERS LABORATORIES INC.  
 CLAPETS ANTI-RETOUR DROITES - HOMOLOGUÉS PAR UNDERWRITERS LABORATORIES INC.  
 DURCHFLOSS RÜCKSCHLAGVENTILE - ZUGELASSEN VON UNDERWRITERS LABORATORIES INC.**

Disegno Drawing Dessin Zeichnung	N° catalogo Part number N° catalogue Katalog Nr.	Attacchi Connections Raccords Anschlüsse			Kv [m <sup>3</sup> /h]	Pressione differenziale Differential pressure Pression différentielle Differenzial Druck (4) [bar]	PS [bar]	TS [°C]		Confezione n° pz Package pcs Emballage Verpackung
		ODS		W				min	max	
		Ø [in.]	Ø [mm]	Ø [mm]						

**Con attacchi ods di rame / with copper ods connections / connexions ods cuivre / verbindung ods kupfer**

	3132EW/2	1/4"	-	-	0,5	0,04	80 (1)	-40	+150	25				
	3132EW/3	3/8"	-	-	1,5									
	3132EW/M10	-	10	-	1,8									
	3132EW/M12	-	12	-										
	3132EW/4	1/2"	-	-	3,3									
	3132EW/5	5/8"	16	-	5									
	3132EW/M18	-	18	-										
	3132EW/6	3/4"	-	-										
	3132EW/7	7/8"	22	-										
	3133EW/2	1/4"	-	-	0,5					0,3	80 (1)	-40	+150	25
	3133EW/3	3/8"	-	-	1,5									
	3133EW/M10	-	10	-	1,8									
	3133EW/M12	-	12	-										
	3133EW/4	1/2"	-	-	3,3									
3133EW/5	5/8"	16	-	5										
3133EW/M18	-	18	-											
3133EW/6	3/4"	-	-											
3133EW/7	7/8"	22	-											

(1): MWP = 1160 psi in conformità a omologazione UL | (1): MWP = 1160 psi according to UL approval | (1): MWP = 1160 psi conformément à homologation UL | (1): MWP = 1160 psi in Übereinstimmung zur UL-Zulassung

**Con attacchi ods di rame rinforzato (k65) / with reinforced copper ods connections (k65) / avec connexion cuivre ods renforcées (k65) / Mit lötlanschluss in kupferausführung (k65)**

	3137EW/2	1/4"	-	-	0,5	0,3	120 (2)	-40	+150	25
	3137EW/3	3/8"	-	-	1,5					
	3137EW/4	1/2"	-	-	1,8					
	3137EW/5	5/8"	16	-	3,3					
	3137EW/6	3/4"	-	--	5					

(2): MWP = 1740 psi in conformità a omologazione UL | (2): MWP = 1740 psi according to UL approval | (2): MWP = 1740 psi conformément à homologation UL | (2): MWP = 1740 psi in Übereinstimmung zur UL-Zulassung

**Con attacchi d'acciaio inossidabile / with stainless steel connections / avec connexion en acier inoxydable / mit anschlüssen aus rostfreiem stahl**

	3138EW/M10	-	-	10	1,5	0,3	140 (3)	-40	+150	25
	3138EW/M12	-	-	12	1,8					
	3138EW/M16	-	-	16	3,3					

(3): MWP = 2030 psi in conformità a omologazione UL | (3): MWP = 2030 psi according to UL approval | (3): MWP = 2030 psi conformément à homologation UL | (3): MWP = 2030 psi in Übereinstimmung zur UL-Zulassung  
 (4): minima pressione a cui la valvola è completamente aperta | (4): minimum pressure at which the valve is completely open | (4): pression minimum à laquelle le clapet est complètement ouvert | (4): minimaler Druck, bei dem das Ventil vollständig geöffnet ist

**VALVOLE DI RITEGNO IN LINEA - OMOLOGATE DA UNDERWRITERS LABORATORIES INC.**  
**STRAIGHT CHECK VALVES - APPROVED BY UNDERWRITERS LABORATORIES INC.**  
**CLAPETS ANTI-RETOUR DROITES - HOMOLOGUÉS PAR UNDERWRITERS LABORATORIES INC.**  
**DURCHFLUSS RÜCKSCHLAGVENTILE - ZUGELASSEN VON UNDERWRITERS LABORATORIES INC.**

Disegno Drawing Dessin Zeichnung	N° catalogo Part number N° catalogue Katalog Nr.	Attacchi Connections Raccords Anschlüsse			Kv [m³/h]	Pressione differenziale Differential pressure Pression différentielle Differenzial Druck (4) [bar]	PS [bar]	TS [°C]		Confezione n° pz Package pcs Emballage Verpackung
		ODS		W				min	max	
		Ø [in.]	Ø [mm]	Ø [mm]						

**Con attacchi ods di rame / with copper ods connections / connexions ods cuivre / verbindung ods kupfer**

	3145EW/7	7/8"	22	-	8,1	0,3	80 (1)	-40	+150	15
	3145EW/M28	-	28	-	10,4					8
	3145EW/9	1.1/8"	-	-	15,6					5
	3145EW/11	1.3/8"	35	-	27					1
	3145EW/13	1.5/8"	-	-	39					
	3145EW/M42	-	42	-						
	3145EW/17	2.1/8"	54	-						

(1): MWP = 1160 psi in conformità a omologazione UL

(1): MWP = 1160 psi according to UL approval

(1): MWP = 1160 psi conformément à homologation UL

(1): MWP = 1160 psi in Übereinstimmung zur UL-Zulassung

**Con attacchi ods di rame rinforzato (k65) / with reinforced copper ods connections (k65) / avec connexion cuivre ods renforcées (k65) / Mit lötlanschluss in kupferausführung (k65)**

	3147EW/7	7/8"	22	-	8,1	0,3	120 (2)	-40	+150	15
	3147EW/9	1.1/8"	-	-	10,4					8
	3147EW/11	1.3/8"	35	-	15,6					5
	3147EW/13	1.5/8"	-	-	27					1
	3147EW/17	2.1/8"	54	-	39					

(2): MWP = 1740 psi in conformità a omologazione UL

(2): MWP = 1740 psi according to UL approval

(2): MWP = 1740 psi conformément à homologation UL

(2): MWP = 1740 psi in Übereinstimmung zur UL-Zulassung

**Con attacchi d'acciaio inossidabile / with stainless steel connections / avec connexion en acier inoxydable / mit anschlüssen aus rostfreiem stahl**

	3148EW/M22	-	-	22	8,1	0,3	140 (3)	-40	+150	15
	3148EW/M28	-	-	28	10,4					8
	3148EW/M35	-	-	35	15,6					5
	3148EW/M42	-	-	42	27					1

(3): MWP = 2030 psi in conformità a omologazione UL

(3): MWP = 2030 psi according to UL approval

(3): MWP = 2030 psi conformément à homologation UL

(3): MWP = 2030 psi in Übereinstimmung zur UL-Zulassung

(4): minima pressione a cui la valvola è completamente aperta

(4): minimum pressure at which the valve is completely open

(4): pression minimum à laquelle le clapet est complètement ouvert

(4): minimaler Druck, bei dem das Ventil vollständig geöffnet ist

**VALVOLE DI RITEGNO A SQUADRA  
RIGHT-ANGLE CHECK VALVES  
CLAPETS ANTI-RETOUR ANGLE DROIT  
WINKELANSCHLUSS RÜCKSCHLAGVENTILE**

Disegno Drawing Dessin Zeichnung	N° catalogo Part number N° catalogue Katalog Nr.	Attacchi Connections Raccords Anschlüsse			Kv [m³/h]	Pressione differenziale Differential pressure Pression différentielle Differenzial Druck (4) [bar]	PS [bar]	TS [°C]		Confezione n° pz Package pcs Emballage Verpackung
		ODS		W				min	max	
		Ø [in.]	Ø [mm]	Ø [mm]						

**Con attacchi ods di rame / with copper ods connections / connexions ods cuivre / verbindung ods kupfer**

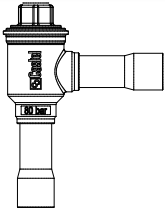
	3185EW/7	7/8"	22	-	9	0,3	80 (1)	-40	+150	14
	3185EW/M28	-	28		19					1
	3185EW/9	1.1/8"	-		29					
	3185EW/11	1.3/8"	35		29					

(1): MWP = 1160 psi in conformità a omologazione UL | (1): MWP = 1160 psi according to UL approval | (1): MWP = 1160 psi conformément à homologation UL | (1): MWP = 1160 psi in Übereinstimmung zur UL-Zulassung

**Con attacchi ods di rame rinforzato (k65) / with reinforced copper ods connections (k65) / avec connexion cuivre ods renforcées (k65) / Mit lötlanschluss in kupferausführung (k65)**

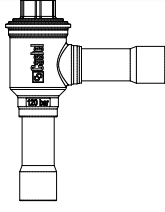
	3187EW/7	7/8"	22	-	9	0,3	120 (2)	-40	+150	14
	3187EW/9	1.1/8"	-		19					1
	3187EW/11	1.3/8"	35		29					

(2): MWP = 1740 psi in conformità a omologazione UL | (2): MWP = 1740 psi according to UL approval | (2): MWP = 1740 psi conformément à homologation UL | (2): MWP = 1740 psi in Übereinstimmung zur UL-Zulassung

**Con attacchi d'acciaio inossidabile / with stainless steel connections / avec connexion en acier inoxydable / mit anschlüssen aus rostfreiem stahl**

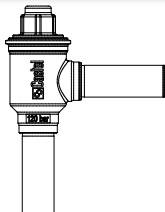
	3188EW/M22	-	-	22	9	0,3	140 (3)	-40	+150	14
	3188EW/M28			28	19					1
	3188EW/M35			35	29					

(3): MWP = 2030 psi in conformità a omologazione UL | (3): MWP = 2030 psi according to UL approval | (3): MWP = 2030 psi conformément à homologation UL | (3): MWP = 2030 psi in Übereinstimmung zur UL-Zulassung  
 (4): minima pressione a cui la valvola è completamente aperta | (4): minimum pressure at which the valve is completely open | (4): pression minimum à laquelle le clapet est complètement ouvert | (4): minimaler Druck, bei dem das Ventil vollständig geöffnet ist

**REGOLATORI DELLA PRESSIONE D'EVAPORAZIONE**  
**EVAPORATING PRESSURE REGULATORS**  
**RÉGULATEURS DE PRESSION D'ÉVAPORATION**  
**VERDAMPFUNGSDRUCKREGLER**

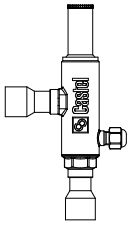
Disegno Drawing Dessin Zeichnung	N° catalogo Part number N° catalogue Katalog Nr.	Attacchi Connections Raccords Anschlüsse			Campo di regolazione Regulation range Plage de régulation Regelbereich [bar]	Kv [m³/h]	PS [bar]	TS [°C]		Confezione n° pz Package pcs Emballage Verpackung
		SAE Flare	ODS [in.]	ODS [mm]				min	max	
	3335EL/M12S	-	-	12	12 - 35	2,7	45	-40	+ 110	15
	3335EL/4S	-	1/2"	-						
	3335EL/5S	-	5/8"	16						
	3335EL/7S	-	7/8"	22						8

**REGOLATORI DELLA PRESSIONE DI CONDENSAZIONE**  
**CONDENSING PRESSURE REGULATORS**  
**RÉGULATEURS DE PRESSION DE CONDENSATION**  
**VERFLÜSSIGUNGSDRUCKREGLER**

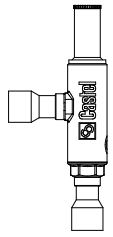
Disegno Drawing Dessin Zeichnung	N° catalogo Part number N° catalogue Katalog Nr.	Attacchi Connections Raccords Anschlüsse			Campo di regolazione Regulation range Plage de régulation Regelbereich [bar]	Kv [m³/h]	PS [bar]	TS [°C]		Confezione n° pz Package pcs Emballage Verpackung
		SAE Flare	ODS [in.]	ODS [mm]				min	max	
	3345EL/M12S	-	-	12	12 - 35	2,7	45	-40	+ 110	15
	3345EL/4S	-	1/2"	-						
	3345EL/5S	-	5/8"	16						
	3345EL/7S	-	7/8"	22						8



**INDICATORI DI UMIDITÀ  
MOISTURE INDICATORS  
VOYANT LIQUIDE AVEC INDICATEURS D' HUMIDITE  
FLUESSIGKEITSINDIKATOREN**

Disegno Drawing Dessin Zeichnung	N° catalogo Part number N° catalogue Katalog Nr.	Attacchi Connections Raccords Anschlüsse			PS [bar]	TS [°C]		Confezione n° pz Package pcs Emballage Verpackung
		ODS		W		min	max	
		Ø [in.]	Ø [mm]	Ø [mm]				

Con attacchi ods di rame / with copper ods connections / avec connexion cuivre ods / mit lötlanschluss in kupferausführung

	3940EL/M6	-	6	-	60	-40	+120	25	
	3940EL/2	1/4"	-	-					
	3940EL/3	3/8"	-	-					
	3940EL/M10	-	10	-					
	3940EL/M12	-	12	-				16	
	3940EL/4	1/2"	-	-					
	3940EL/5	5/8"	16	-					
	3940EL/M18	-	18	-					
	3940EL/6	3/4"	-	-					21
	3940EL/7	7/8"	22	-					
	3940EL/M28	-	28	-					
	3940EL/9	1.1/8"	-	-					16

Con attacchi ods di rame / with copper ods connections / avec connexion cuivre ods / mit lötlanschluss in kupferausführung

	3740E/M6	-	6	-	80	-40	+120	25	
	3740E/2	1/4"	-	-					
	3740E/3	3/8"	-	-					
	3740E/M10	-	10	-					
	3740E/M12	-	12	-				16	
	3740E/4	1/2"	-	-					
	3740E/5	5/8"	16	-					
	3740E/M18	-	18	-					
	3740E/6	3/4"	-	-					21
	3740E/7	7/8"	22	-					
	3740E/M28	-	28	-					
	3740E/9	1.1/8"	-	-					16

**INDICATORI DI UMIDITÀ  
MOISTURE INDICATORS  
VOYANT LIQUIDE AVEC INDICATEURS D' HUMIDITE  
FLUESSIGKEITSINDIKATOREN**

Disegno Drawing Dessin Zeichnung	N° catalogo Part number N° catalogue Katalog Nr.	Attacchi Connections Raccords Anschlüsse			PS [bar]	TS [°C]		Confezione n° pz Package pcs Emballage Verpackung
		ODS		W		min	max	
		Ø [in.]	Ø [mm]	Ø [mm]				

Con attacchi ods di rame rinforzato (k65) / with reinforced copper ods connections (k65) / avec connexion cuivre ods renforcées (k65) / Mit lötlanschluss in kupferausführung (k65)

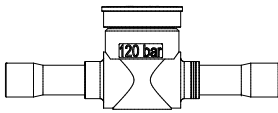
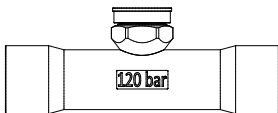
	3747E/2	1/4"	-	-	120	-40	+120	25	
	3747E/3	3/8"	-	-					
	3747E/4	1/2"	-	-					
	3747E/5	5/8"	16	-				16	
	3747E/6	3/4"	-	-					
	3747E/7	7/8"	22	-					21
	3747E/9	1.1/8"	-	-					16
	3777E/11	1.3/8"	35	-	17				

Con attacchi d'acciaio inossidabile / with stainless steel connections / avec connexion en acier inoxydable / mit anschlüssen aus rostfreiem stahl

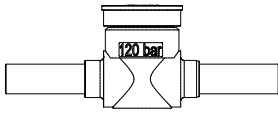
	3748E/M6	-	-	6	120	-40	+120	25	
	3748E/M10	-	-	10					
	3748E/M12	-	-	12					
	3748E/M16	-	-	16				16	
	3748E/M18	-	-	18					
	3748E/M22	-	-	22					21
	3748E/M28	-	-	28					16

**FILTRI DISIDRATATORI A CARTUCCIA SOLIDA 100% SETACCIO MOLECOLARE**  
**SOLID CORE FILTER DRIERS 100% MOLECULAR SIEVES**  
**FILTRES DÉSHYDRATEURS AVEC CARTOUCHE SOLIDE 100% TAMIS MOLECULAIRE**  
**FILTERTROCKNER MIT 100% MOLEKULARSIEB**

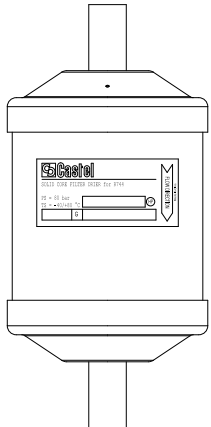
Disegno Drawing Dessin Zeichnung	N° catalogo Part number N° catalogue Katalog Nr.	Codice internazionale International code Code international Internationaler code	Attacchi Connections Raccords Anschlüsse		Cubatura nominale Nominal volume Cubature nominale Nominaler rauminhalt [cm <sup>3</sup> ]	PS [bar]	TS [°C]		Confezione n° pz Package pcs Emballage Verpackung
			ODS				min	max	
			Ø [in.]	Ø [mm]					
	DF303E/2S	032S	1/4"	-	50	80	-40	+80	25
	DF303E/3S	033S	3/8"	-					
	DF305E/2S	052S	1/4"	-	80				
	DF305E/3S	053S	3/8"	-					
	DF305E/M10S	-	-	10					
	DF308E/2S	082S	1/4"	-	130				
	DF308E/3S	083S	3/8"	-					
	DF308E/M10S	-	-	10					
	DF308E/M12S	-	-	12					
	DF308E/4S	084S	1/2"	-	250				
	DF316E/3S	163S	3/8"	-					
	DF316E/M10S	-	-	10					
	DF316E/M12S	-	-	12					
	DF316E/4S	164S	1/2"	-					
	DF316E/5S	165S	5/8"	16	500				
	DF330E/3S	303S	3/8"	-					
	DF330E/4S	304S	1/2"	-					
	DF330E/5S	305S	5/8"	16	670				
	DF341E/4S	414S	1/2"	-					
	DF341E/5S	415S	5/8"	16					

**FILTRI DISIDRATATORI A CARTUCCIA SOLIDA 100% SETACCIO MOLECOLARE, CON INDICATORE D'UMIDITA' - ATTACCHI A SALDARE**  
**SOLID CORE FILTER DRIERS 100% MOLECULAR SIEVES, WITH MOISTURE INDICATOR - SOLDER CONNECTIONS**  
**FILTRES DÉSHYDRATEURS AVEC CARTOUCHE SOLIDE 100% TAMIS MOLECULAIRE, ET INDICATEUR D' HUMIDITE - RACCORDS A SOUDER**  
**FILTERTROCKNER 100% MOLEKULARSIEB MIT FLÜSSIGKEITSINDIKATOREN - LÖTANSCHLUSS**

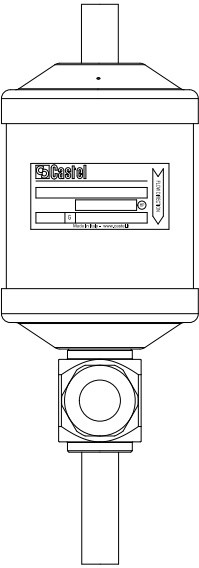
Disegno Drawing Dessin Zeichnung	N° catalogo Part number N° Catalogue Katalog Nr		Codice internazionale International code Code international Internationaler code		Attacchi Connections Raccords Anschlüsse		Cubatura nominale Nominal volume Cubature nominale Nominaler rauminhalt		PS [bar]	TS [°C]		Confezione n° pz Package pcs Emballage Verpackung
					ODS		[cm³]	Min		Max		
					Ø [in.]	Ø [mm]						
	NEW	DI305E/2S	052S	1/4"	-							15
	NEW	DI305E/3S	053S	3/8"	-	80						
	NEW	DI305E/M10S	-	-	10							
	NEW	DI308E/2S	082S	1/4"	-							15
	NEW	DI308E/3S	083S	3/8"	-							
	NEW	DI308E/M10S	-	-	10	130						
	NEW	DI308E/M12S	-	-	12							
	NEW	DI308E/4S	084S	1/2"	-							15
	NEW	DI316E/3S	163S	3/8"	-							
	NEW	DI316E/M10S	-	-	10				80	-40	+80	
	NEW	DI316E/M12S	-	-	12	250						
	NEW	DI316E/4S	164S	1/2"	-							
	NEW	DI316E/5S	165S	5/8"	16							
	NEW	DI330E/3S	303S	3/8"	-							1
	NEW	DI330E/4S	304S	1/2"	-	500						
	NEW	DI330E/5S	305S	5/8"	16							
	NEW	DI341E/4S	414S	1/2"	-							1
	NEW	DI341E/5S	415S	5/8"	16	670						

**FILTRI DISIDRATATORI A CARTUCCIA SOLIDA RICAMBIABILE - ATTACCHI D'ACCIAIO**  
**FILTER DRIERS WITH REPLACEABLE SOLID CORE - STEEL CONNECTIONS**  
**FILTRES DÉSHYDRATEURS AVEC CARTOUCHE SOLIDE REMPLAÇABLE - RACCORDS EN ACIER**  
**FILTERTROCKNER FÜR UNIVERSAL BLOCKEINSATZ - STAHL-ANSCHLÜSSE**

Disegno Drawing Dessin Zeichnung	N° Catalogo Part number N° catalogue Katalog Nr		Attacchi Connections Raccords Anschlüsse			Tipo cartucce Cores type Type cartouches Patronentyp	N° cartucce N° of cores N° cartouches Patronenanzahl	Cubatura nominale Nominal volume Cubature nominale Nominaler rauminhalt [cm³]	PS [bar]		TS [°C]		Confezione n° pz Package pcs Emballage Verpackung
	Coperchio filettato Threaded cover Couvercle fileté Schraubkappe	Coperchio cieco Blind cover Couvercle borgne Blindkappe	ODS		W				min	max			
			Ø [in.]	Ø [mm]							Ø [mm]		
	4411E/5AF	4411E/5BF	5/8"	16	21,3	4490/B	1	800	62	-40	+80	1	
	4411E/7AF	4411E/7BF	7/8"	22	26,9								
	4411E/9AF	4411E/9BF	1.1/8"	-	33,7								
	4411E/11AF	4411E/11BF	1.3/8"	35	42,4								
	4411E/13AF	4411E/13BF	1.5/8"	-	48,3								
	4411E/M42AF	4411E/M42BF	-	42	48,3								
	4411E/17AF	4411E/17BF	2.1/8"	54	60,3								
	4412E/7AF	4412E/7BF	7/8"	22	26,9	2	1600	62	-40	+80	1		
	4412E/9AF	4412E/9BF	1.1/8"	-	33,7								
	4412E/11AF	4412E/11BF	1.3/8"	35	42,4								
	4412E/13AF	4412E/13BF	1.5/8"	-	48,3								
	4412E/M42AF	4412E/M42BF	-	42	48,3								
	4412E/17AF	4412E/17BF	2.1/8"	54	60,3								

**CARTUCCE PER FILTRI DISIDRATATORI**  
**CARTRIDGES**  
**CARTOUCHE SOLIDE**  
**BLOCKEINSÄTZE**

Disegno Drawing Dessin Zeichnung	N° catalogo Part number N° catalogue Katalog Nr.	Carica disidratante Dehydrating charge Charge déshydratant Bindemittel	N° cartucce N° of cores N° cartouches Patronenanzahl	Adatta per filtri Suitable for filter Adapté pour filtre Passend für filter	Confezione n° pz Package pcs Emballage Verpackung
	4490/B (1)	100 % Setaccio molecolare 100% Molecular sieve 100% Tamis moleculaire 100% Molekularsieb	800	4411E/_AF-BF 4412E/_AF-BF	15
	4490/AB (1)	80% Setaccio molecolare + 20% allumina attivata 80% Molecular sieve + 20% activated alumina 80% Tamis moleculaire + 20% alumine activee 80% molekularsieb + 20% aktivem aluminium	800	4411E/_AF-BF 4412E/_AF-BF	15
	<b>NEW</b> 4490/E (2)	100 % Setaccio molecolare 100% Molecular sieve 100% Tamis moleculaire 100% Molekularsieb	800	4411E/_AF-BF 4412E/_AF-BF	15

(1)  
Fornita senza guarnizione di ricambio del coperchio del filtro

(2)  
Fornita con guarnizione di ricambio del coperchio del filtro

(1)  
Supplied without cover gasket as spare part

(2)  
Supplied with cover gasket as spare part

(1)  
Fournie sans joint de rechange du couvercle du filtre

(2)  
Fournie avec joint de rechange du couvercle du filtre

(1)  
Ohne Ersatzdichtung für Filtergegenflansch geliefert

(2)  
Mit Ersatzdichtung für Filtergegenflansch geliefert

**CARTUCCE PER FILTRI MECCANICI**  
**MECHANICAL BLOCKS**  
**CARTOUCHE PUOR FILTRES MÉCANIQUE**  
**FILTREINSATZ FÜR MECHANISCHE FILTER**

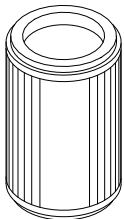
Disegno Drawing Dessin Zeichnung	N° catalogo Part number N° catalogue Katalog Nr.	Superficie filtrante Filtering surface Surface filtrante Filterflaeche [cm <sup>2</sup> ]	Per filtri Suitable for filter Pour filtre Für filter	Confezione n° pz Package pcs Emballage Verpackung
	NEW 4495/E	820	4411E/_AF + 9150/R57	15

(1) sostituire componenti interni con ricambio 9151/R02

(1) replace internal components with spare part 9151/R02

(1) remplacer les composants internes par la pièce de rechange 9151/R02

(1) Ersetzen Sie die internen Komponenten durch das Ersatzteil 9151/R02

**ACCESSORI**  
**ACCESSORIES**  
**ACCESSOIRES**  
**ZUBEHÖR**

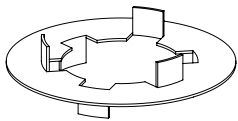
Disegno Drawing Dessin Zeichnung	N° catalogo Part number N° catalogue Katalog Nr	Componenti Parts Composant Komponenten	Per filtri Suitable for filter Pour filtre Für filter	Confezione n° pz Package pcs. Emballage Verpackung
	9900/X74	Disco centratore per due cartucce meccaniche Centering disc for two blocks Disque de centrage pour deux cartouches Zentrierscheibe für zwei Filtereinsätze	4412E/_AF (1)	1

(1) sostituire componenti interni con ricambio 9151/R02

(1) replace internal components with spare part 9151/R02

(1) remplacer les composants internes par la pièce de rechange 9151/R02

(1) Ersetzen Sie die internen Komponenten durch das Ersatzteil 9151/R02

**FILTRI A RETE**  
**STRAINERS**  
**FILTRES AVEC TAMIS MÉTALLIQUE**  
**NETZFILTER**

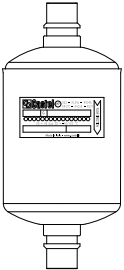
Disegno Drawing Dessin Zeichnung	N° catalogo Part number N° catalogue Katalog Nr.	Attacchi Connections Raccords Anschlüsse				Superficie filtrante Filtering surface Surface filtrante Filterflaeche [cm <sup>2</sup> ]	Kv [m <sup>3</sup> /h]	PS [bar]	TS [°C]		Confezione n° pz Package pcs Emballage Verpackung
		ODS		ODM					min	max	
		Ø [in.]	Ø [mm]	Ø [in.]	Ø [mm]						
	4520E/M10	-	10	-	12	2,4	60	-40	+80	34	
	4520E/M12	-	12	-	14	3,4					
	4520E/4	1/2"	-	5/8"	16	3,4					
	4520E/5	5/8"	16	3/4"	-	3,4					

**FILTRI A RETE - OMOLOGATI DA UNDERWRITERS LABORATORIES INC.**  
**STRAINERS - APPROVED BY UNDERWRITERS LABORATORIES INC.**  
**FILTRES EN TAMIS MÉTALLIQUE - HOMOLOGUÉS PAR UNDERWRITERS LABORATORIES INC.**  
**NETZFILTER - ZUGELASSEN VON UNDERWRITERS LABORATORIES INC.**

CON ATTACCHI ODS DI RAME RINFORZATO (K65) / WITH REINFORCED COPPER ODS CONNECTIONS (K65) / AVEC CONNEXION CUIVRE ODS RENFORCÉES (K65) / MIT LÖTANSCHLUSS IN KUPFERAUSFÜHRUNG (K65)

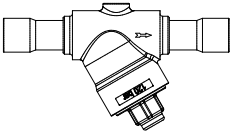
Disegno Drawing Dessin Zeichnung	N° catalogo Part number N° Catalogue Katalog Nr	Attacchi Connections Raccords Anschlüsse	Superficie filtrante Filtering surface Surface filtrante Filterflaeche	Luce maglia Mesh-opening Entraxe mailles Maschenweite	Kv [m³/h]	PS [bar]	TS [°C]		Confezione n° pz Package pcs Emballage Verpackung			
		ODS	[cm²]	[mm]			Min	Max				
		Ø [in.]										
	4727E/3	3/8"	13	0,1	2	120 (1)	-40	+140	15			
	4727E/4	1/2"	13		2,5							
	4727E/5	5/8"	13		3							
	4727E/6	3/4"	18	0,2	6				120 (1)	-40	+140	8
	4727E/7	7/8"	18		6							
	4727E/9	1.1/8"	18		6							
	4727E/11	1.3/8"	31		7							1
	4727E/13	1.5/8"	46		10							
	4727E/17	2.1/8"	60		15							

(1): MWP = 1740 psi in conformità a omologazione UL

(1): MWP = 1740 psi according to UL approval

(1): MWP = 1740 psi conformément à homologation UL

(1): MWP = 1740 psi in Übereinstimmung zur UL-Zulassung

**CON ATTACCHI D'ACCIAIO INOSSIDABILE / WITH STAINLESS STEEL CONNECTIONS / AVEC CONNEXION EN ACIER INOXYDABLE / MIT ANSCHLÜSSEN AUS ROSTFREIEM STAHL**

Disegno Drawing Dessin Zeichnung	N° catalogo Part number N° Catalogue Katalog Nr	Attacchi Connections Raccords Anschlüsse	Superficie filtrante Filtering surface Surface filtrante Filterflaeche	Luce maglia Mesh-opening Entraxe mailles Maschenweite	Kv [m³/h]	PS [bar]	TS [°C]		Confezione n° pz Package pcs Emballage Verpackung			
		ODS	[cm²]	[mm]			Min	Max				
		W [mm]										
	4728E/M10	10	13	0,1	2	140 (2)	-40	+140	15			
	4728E/M12	12	13		2,5							
	4728E/M16	16	13		3							
	4728E/M18	18	18	0,2	6				120 (3)	-40	+140	8
	4728E/M22	22	18		6							
	4728E/M28	28	18		6							
	4728E/M35	35	31		7							1
	4728E/M42	42	46		10							

(2): MWP = 2030 psi in conformità a omologazione UL

(2): MWP = 2030 psi according to UL approval

(2): MWP = 2030 psi conformément à homologation UL

(2): MWP = 2030 psi in Übereinstimmung zur UL-Zulassung

(3): MWP = 1740 psi in conformità a omologazione UL

(3): MWP = 1740 psi according to UL approval

(3): MWP = 1740 psi conformément à homologation UL

(3): MWP = 1740 psi in Übereinstimmung zur UL-Zulassung

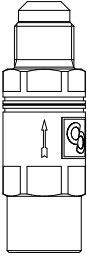

**VALVOLE TARATE PER RISERVA D'OLIO**  
**OIL RESERVOIR PRESSURE VALVES**  
**CLAPETS TARÉ POUR RÉSERVOIR D'HUILE**  
**DRUCKVENTILE FÜR ÖLSAMMELGEFÄSS**

Disegno Drawing Dessin Zeichnung	N° Catalogo Part number N° Catalogue Katalog nr	Attacchi connections Raccords Anschlüsse SAE FLARE		Kv [m <sup>3</sup> /h]	Pressione differenziale Differential pressure Pression différentielle Differenzial Druck [bar]	PS [bar]	TS [°C]		Confezione n° pz Package pcs Emballage Verpackung
		IN	OUT				Min	Max	
	3150W/X04				7				
	3150W/X05	3/8" - F	3/8" - M	1,6	9	140	-40	+150	16
	3150W/X06				12				

**REGOLATORI ELETTRONICI DI LIVELLO DELL'OLIO**  
**ELECTRONIC OIL LEVEL REGULATORS**  
**RÉGULATEURS DE NIVEAU D'HUILE ÉLECTRONIQUE**  
**ELEKTRONISCHEN ÖLSPIEGELREGULATOREN**

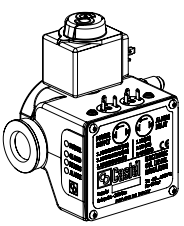
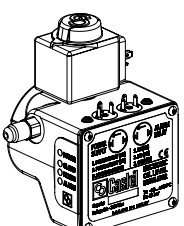
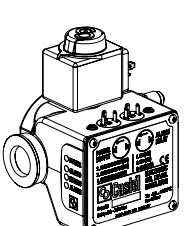
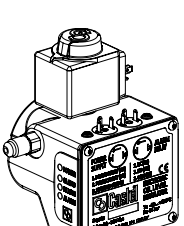
Disegno Drawing Dessin Zeichnung	N° catalogo Part number N° catalogue Katalog Nr	Attacchi Connections Raccords Anschlüsse			Versione Version Modèl Ausführung	Tensione Voltage Tension Spannung	Frequenza Frequency Fréquence Frequenz	Grado di protezione Degree of protection Degrè de protection Schutzgrad	Kit cavi Cables kit Câbles kit Kabel- Kit	PS [bar]	TS [°C]		Confezione n° pz Package pcs Emballage Verpackung																		
		Adattatori carter compressore crankcase adapters Adaptateurs de carter du compresseur Kurbelgehäuse- Adapter	Spia livello olio Oil level inspection Hublot de contrôle de niveau d'huile Ölschauglas	Ingresso olio Oil inlet Entree d'huile Öleintritt							[V]	[Hz]		(1)	Min	Max															
																	(1)	SAE FLARE													
	NEW 5650E/11RA2	5690/X11 5690/X12 5690/X13 5690/X14 5690/X15 5690/X16 5690E/X01	1 spia di livello 1 sight glass 1 indicateur 1 Schauglas	3/8"	Destro Right Droit Recht	24 AC	50/60	IP 65	9901/ X26	90	-30	+130	1																		
	NEW 5650E/11RA6					220 AC	50/60																								
	NEW 5650E/11LA2				5690/X11 5690/X12 5690/X13 5690/X14 5690/X15 5690/X16 5690E/X01	1 spia di livello 1 sight glass 1 indicateur 1 Schauglas	3/8"							Sinistro Left Gauche Link	24 AC	50/60	IP 65	9901/ X26	90	-30	+130	1									
	NEW 5650E/11LA6														220 AC	50/60															
	NEW 5658E/07RA2													5690/X11 5690/X12 5690/X13 5690/X14 5690/X15 5690/X16 5690E/X01	1 spia di livello 1 sight glass 1 indicateur 1 Schauglas	3/8"							Destro Right Droit Recht	24 AC	50/60	IP 65	9901/ X26	140	-30	+130	1
	NEW 5658E/07RA6																							220 AC	50/60						
	NEW 5658E/07LA2	5690/X11 5690/X12 5690/X13 5690/X14 5690/X15 5690/X16 5690E/X01	1 spia di livello 1 sight glass 1 indicateur 1 Schauglas	3/8"				Sinistro Left Gauche Link	24 AC	50/60	IP 65	9901/ X26	140										-30	+130	1						
	NEW 5658E/07LA6								220 AC	50/60																					

(1) Da ordinare separatamente

(1) To be ordered separately



(1) Doit être commandé séparément

(1) Sind separat zu bestellen

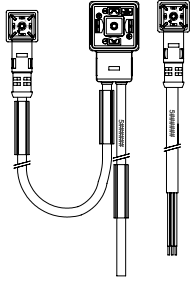
**KIT CAVI**  
**CABLES KIT**  
**CÂBLES KIT**  
**KABEL-KIT**

Disegno Drawing Dessin Zeichnung	N° Catalogo Part number N° Catalogue Katalog Nr		Impiego Use Usage Benutzen	Grado di protezione Degree of protection Degrè de protection Schutz - klasse	Lunghezza cavo Cable length Longueur du câble Kabellänge	Confezione n° pz Package pcs Emballage Verpackung
					[m]	
	NEW	9901/X26	Cavo alimentazione Power supply cable Câble d'alimentation Stromversorgungskabel	IP 65	3	1
			Cavo allarmi Alarms cable câble alarmes Alarmkabel	IP 65	3	

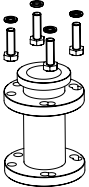
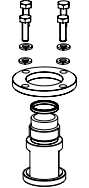
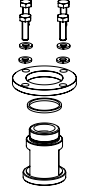
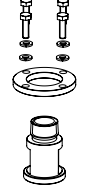
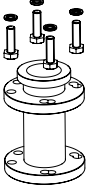
**ADATTATORI PER REGOLATORI DI LIVELLO DELL'OLIO**  
**OIL LEVEL REGULATORS ADAPTERS**  
**ADAPTATEURS POUR RÉGULATEURS DE NIVEAU D'HUILE**  
**ADAPTER FÜR ÖLSPIEGELREGULATOR-**

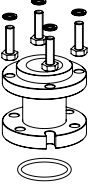
Disegno Drawing Dessin Zeichnung	N° catalogo Part number N° catalogue Katalog Nr	Attacchi carter compressore Compressor crankcase connections Raccords carter du compresseur Verdichter-Kurbelgehäuse Anschlüsse	Confezione n° pz Package pcs Emballage Verpackung
	NEW 5690/X11	Flangiato con 3 fori su Ø 1.7/8 e 4 fori su Ø 50 mm Flanged with 3 holes on dia 1.7/8" and 4 holes on dia 50 mm Joint torique avec 3 trous sur Ø 1.7/8 et 4 trous sur Ø 50 mm Flansch mit 3 Löcher vom Ø 1.7/8" und 4 Löcher vom Ø 50 mm L = 83 mm	1
	NEW 5690/X12	Filettato 1.1/8" - 12 UNF 1.1/8" - 12 UNF thread Fileté 1.1/8" - 12 UNF Gewinde 1.1/8" - 12 UNF	1
	NEW 5690/X13	Filettato 1.1/8" - 18 UNEF 1.1/8" - 18 UNEF thread Fileté 1.1/8" - 18 UNEF Gewinde 1.1/8" - 18 UNEF	1
	NEW 5690/X14	Filettato 3/4" NPT 3/4" NPT thread Fileté 3/4" NPT Gewinde 3/4" NPT	1
	NEW 5690/X15	Flangiato con 3 fori su Ø 1.7/8 e 4 fori su Ø 50 mm Flanged with 3 holes on dia 1.7/8" and 4 holes on dia 50 mm Joint torique avec 3 trous sur Ø 1.7/8 et 4 trous sur Ø 50 mm Flansch mit 3 Löcher vom Ø 1.7/8" und 4 Löcher vom Ø 50 mm L = 53 mm	1
	NEW 5690/X16	Rotalock 1.1/4" - 12 UNF	1
	NEW 5690E/X01	Flangiato con 6 fori su Ø 1.7/8 e 4 fori su Ø 50 mm Flanged with 6 holes on dia 1.7/8" and 4 holes on dia 50 mm Joint torique avec 6 trous sur Ø 1.7/8 et 4 trous sur Ø 50 mm Flansch mit 6 Löcher vom Ø 1.7/8" und 4 Löcher vom Ø 50 mm L = 53 mm	1

**RUBINETTI PER SISTEMI FRIGORIFERI ERMETICI**  
**VALVES FOR HERMETIC SYSTEMS**  
**VANNES POUR INSTALLATIONS DE GROUPES HERMÉTIQUES**  
**KLEINVENTILE FÜR HERMETISCHE KÄLTEANLAGEN**

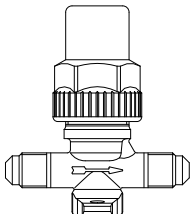
Disegno Drawing Dessin Zeichnung	N° catalogo Part number N° Catalogue Katalog Nr	Attacchi Connections Raccords Anschlüsse				Kv [m³/h]	PS [bar]	TS [°C]		Confezione n° pz Package pcs Emballage Verpackung
		SAE Flare		ODS				Min	Max	
				Ø [in.]						
	6010E/2	1/4"	1/4"	-	-	0,27	140	-40	+130	45
	6012E/22	1/4"	-	1/4"	-					72

**RUBINETTI PER SERBATOIO**  
**RECEIVER VALVES**  
**VANNES POUR RÉSERVOIR**  
**SAMMLER VENTILE**

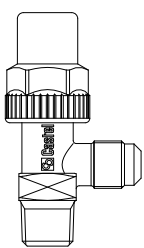
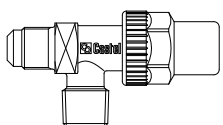
Disegno Drawing Dessin Zeichnung	N° catalogo Part number N° Catalogue Katalog Nr.	Attacchi Connections Raccords Anschlüsse			Kv [m³/h]	PS [bar]	TS [°C]		Confezione n° pz Package pcs Emballage Verpackung
		SAE Flare	SAE Flare	NPT			min	max	
	6110E/22	-	1/4"	1/4"	0,44	140	-40	+130	90
	6110E/X15	1/4" F	1/4"	-	-				
	6110E/33	-	3/8"	3/8"	1,35				
	6110E/X13	3/8" F	3/8"	-	-				
	6110E/44	-	1/2"	1/2"	3,4				
	6120E/22	-	1/4"	1/4"	0,44	140	-40	+130	90
	6120E/33	-	3/8"	3/8"	1,35				
	6120E/44	-	1/2"	1/2"	3,4				

**RUBINETTI A CAPPELOTTO**  
**CAPPED VALVES**  
**VANNES A CAPUCHON**  
**KAPPENVENTILE**

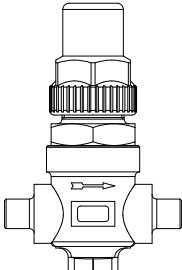
Disegno Drawing Dessin Zeichnung	N° catalogo Part number N° catalogue Katalog Nr.	Attacchi Connections Raccords Anschlüsse			Kv [m³/h]	PS [bar]	TS [°C]		Confezione n° pz Package pcs Emballage Verpackung
		SAE FLARE	ODS				min	max	
			Ø [in.]	Ø [mm]					
	6420E/2	-	1/4"	-	0,4	120	-40	+130	45
	6420E/3	-	3/8"	-	1				
	6420E/3S3	3/8" - OUT	3/8" - IN	-	1				
	6420E/4	-	1/2"	-	1,45				

**RUBINETTI A SFERA CON ATTACCHI ODS DI RAME**  
**BALL VALVES WITH COPPER ODS CONNECTIONS**  
**VANNES A BOISSEAU SPHÉRIQUE AVEC CONNEXION CUIVRE ODS**  
**KUGELABSPERRVENTILE MIT LÖTANSCHLUSS IN KUPFERAUSFÜHRUNG**

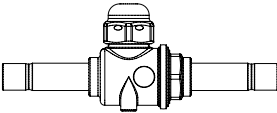
Disegno Drawing Dessin Zeichnung	N° catalogo Part number N° Catalogue Katalog Nr	Attacchi Connections Raccords Anschlüsse		Foro Sfera Ø Ball port Ø Orifice bille Ø Bohrung Ø	Kv [m³/h]	PS [bar]	TS [°C]		Confezione n° pz Package pcs Emballage Verpackung	
		ODS					min.	max.		
		Ø [in.]	Ø [mm]							[mm]
	6570EL/M6	-	6	10	0,8	60	-40	+150	25	
	6570EL/2	1/4"	-		3					
	6570EL/3	3/8"	-		5					
	6570EL/M10	-	10		17					
	6570EL/M12	-	12		29					
	6570EL/4	1/2"	-		51					
	6570EL/5	5/8"	16	25	86				117	6
	6570EL/M18	-	18							
	6570EL/6	3/4"	-	50	214				1	
	6570EL/7	7/8"	22							50
	6570EL/M28	-	28	50	214				1	
	6570EL/9	1.1/8"	-							50
	6570EL/11	1.3/8"	35	50	214				1	
	6570EL/13	1.5/8"	-							50
	6570EL/M42	-	42	50	214				1	
	6570EL/17	2.1/8"	54							50

**RUBINETTI A SFERA CON ATTACCHI ODS DI RAME - OMOLOGATE DA UNDERWRITERS LABORATORIES INC.**  
**BALL VALVES WITH COPPER ODS CONNECTIONS - APPROVED BY UNDERWRITERS LABORATORIES INC.**  
**VANNES A BOISSEAU SPHÉRIQUE AVEC CONNEXION CUIVRE ODS - HOMOLOGUÉS PAR UNDERWRITERS LABORATORIES INC.**  
**KUGELABSPERRVENTILE MIT LÖTANSCHLUSS IN KUPFERAUSFÜHRUNG - ZUGELASSEN VON UNDERWRITERS LABORATORIES INC.**

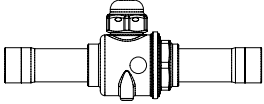
Disegno Drawing Dessin Zeichnung	N° catalogo Part number N° Catalogtue Katalog Nr	Attacchi Connections Raccords Anschlüsse		Foro Sfera Ø Ball port Ø Orifice bille Ø Bohrung Ø	Kv [m³/h]	PS [bar]	TS [°C]		Confezione n° pz Package pcs Emballage Verpackung			
		ODS					min.	max.				
		Ø [in.]	Ø [mm]									
	6570E/M6	–	6	10	0,8	80 (1)	-40	+150	25			
	6570E/2	1/4"	–		15					3		
	6570E/3	3/8"	–							17	5	
	6570E/M10	–	10								19	29
	6570E/M12	–	12									21
	6570E/4	1/2"	–	25	51				16			
	6570E/5	5/8"	16		32					86	6	
	6570E/M18	–	18	40					117	6		
	6570E/6	3/4"	–		50				214		1	
	6570E/7	7/8"	22									
	6570E/M28	–	28									
	6570E/9	1.1/8"	–									
	6570E/11	1.3/8"	35									
	6570E/13	1.5/8"	–									
	6570E/M42	–	42									
	6570E/17	2.1/8"	54									

(1): MWP = 1160 psi in conformità a omologazione UL

(1): MWP = 1160 psi according to UL approval

(1): MWP = 1160 psi conformément à homologation UL

(1): MWP = 1160 psi in Übereinstimmung zur UL-Zulassung

**RUBINETTI A SFERA CON ATTACCHI ODS DI RAME, CON ATTACCO DI CARICA**  
**BALL VALVES WITH ODS COPPER CONNECTIONS, WITH ACCESS FITTING**  
**VANNES A BOISSEAU SPHÉRIQUE AVEC CONNEXION CUIVRE ODS, AVEC RACCORD DE CHARGE**  
**KUGELABSPERRVENTILE MIT LÖTANSCHLUSS IN KUPFERAUSFÜHRUNG, MIT SCHRADER**

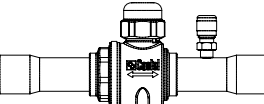
Disegno Drawing Dessin Zeichnung	N° catalogo Part number N° Catalogtue Katalog Nr	Attacchi Connections Raccords Anschlüsse		Foro Sfera Ø Ball port Ø Orifice bille Ø Bohrung Ø	Kv [m³/h]	PS [bar]	TS [°C]		Confezione n° pz Package pcs Emballage Verpackung			
		ODS					min.	max.				
		Ø [in.]	Ø [mm]									
	6570E/M6A	–	6	10	0,8	80	-40	+150	25			
	6570E/2A	1/4"	–		15					3		
	6570E/3A	3/8"	–							17	5	
	6570E/M10A	–	10								19	29
	6570E/M12A	–	12									21
	6570E/4A	1/2"	–	25	51				16			
	6570E/5A	5/8"	16		32					86	6	
	6570E/M18A	–	18	40					117	6		
	6570E/6A	3/4"	–		50				214		1	
	6570E/7A	7/8"	22									
	6570E/M28A	–	28									
	6570E/9A	1.1/8"	–									
	6570E/11A	1.3/8"	35									
	6570E/13A	1.5/8"	–									
	6570E/M42A	–	42									
	6570E/17A	2.1/8"	54									

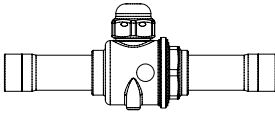

**RUBINETTI A SFERA CON ATTACCHI ODS DI RAME RINFORZATO (K65) - OMOLOGATE DA UNDERWRITERS LABORATORIES INC.**  
**BALL VALVES WITH REINFORCED COPPER ODS CONNECTIONS (K65) - APPROVED BY UNDERWRITERS LABORATORIES INC.**  
**VANNES A BOISSEAU SPHÉRIQUE AVEC CONNEXION CUIVRE ODS RENFORCÉES (K65) - HOMOLOGUÉS PAR UNDERWRITERS LABORATORIES INC.**  
**KUGELABSPERRVENTILE MIT LÖTANSCHLUSS IN KUPFERAUSFÜHRUNG (K65) - ZUGELASSEN VON UNDERWRITERS LABORATORIES INC.**

Disegno Drawing Dessin Zeichnung	N° catalogo Part number N° Catalogue Katalog Nr	Attacchi Connections Raccords Anschlüsse		Foro Sfera Ø Ball port Ø Orifice bille Ø Bohrung Ø	Kv [m³/h]	PS [bar]	TS [°C]		Confezione n° pz Package pcs Emballage Verpackung	
		ODS					min.	max.		
		Ø [in.]	Ø [mm]	[mm]						
	6577E/2	1/4"	–	10	0,8	130 (1)	-40	+150	25	
	6577E/3	3/8"	–		3					
	6577E/4	1/2"	–		5					
	6577E/5	5/8"	16	15	17				16	
	6577E/6	3/4"	–		19					29
	6577E/7	7/8"	22	19	29				8	
	6577E/9	1.1/8"	–	25	51				6	
	6577E/11	1.3/8"	35	32	86					
	6577E/13	1.5/8"	–	40	117				130 (2)	1
	6577E/17	2.1/8"	54	50	214				120 (3)	

(1): MWP = 1885 psi in conformità a omologazione UL  
 (2): MWP = 1740 psi in conformità a omologazione UL  
 (3): non omologato UL

(1): MWP = 1885 psi according to UL approval  
 (2): MWP = 1740 psi according to UL approval  
 (3): not UL approved

(1): MWP = 1885 psi conformément à homologation UL  
 (2): MWP = 1740 psi conformément à homologation UL  
 (3): Pas approuvé UL

(1): MWP = 1885 psi in Übereinstimmung zur UL-Zulassung  
 (2): MWP = 1740 psi in Übereinstimmung zur UL-Zulassung  
 (3): Ohne UL-Zertifizierung

**RUBINETTI A SFERA CON ATTACCHI D'ACCIAIO INOSSODABILE - OMOLOGATE DA UNDERWRITERS LABORATORIES INC.**  
**BALL VALVES WITH STAINLESS STEEL CONNECTIONS - APPROVED BY UNDERWRITERS LABORATORIES INC.**  
**VANNES A BOISSEAU SPHÉRIQUE AVEC CONNEXION EN ACIER INOXYDABLE - HOMOLOGUÉS PAR UNDERWRITERS LABORATORIES INC.**  
**KUGELABSPERRVENTILE MIT ANSCHLÜSSEN AUS ROSTFREIEM STAHL - ZUGELASSEN VON UNDERWRITERS LABORATORIES INC.**

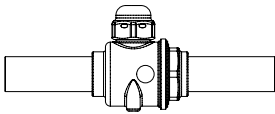
Disegno Drawing Dessin Zeichnung	N° catalogo Part number N° Catalogue Katalog Nr	Attacchi Connections Raccords Anschlüsse		Foro Sfera Ø Ball port Ø Orifice bille Ø Bohrung Ø	Kv [m³/h]	PS [bar]	TS [°C]		Confezione n° pz Package pcs Emballage Verpackung	
		W					min.	max.		
		Ø [mm]		[mm]						
	6578E/M6	6		10	0,8	140 (1)	-40	+150	25	
	6578E/M10	10			3					
	6578E/M12	12			5					
	6578E/M16	16		15	17				16	
	6578E/M18	18			19					29
	6578E/M22	22		19	29				8	
	6578E/M28	28		25	51				6	
	6578E/M35	35		32	86					
	6578E/M42	42		40	117				1	
	6578E/M48	48,3		40	117					140 (2)
	6578E/M60	60,3		50	214					120 (2)
	6578E/M73	73		60	380					

(1): MWP = 2030 psi in conformità a omologazione UL  
 (2): non omologato UL

(1): MWP = 2030 psi according to UL approval  
 (2): not UL approved

(1): MWP = 2030 psi conformément à homologation UL  
 (2): Pas approuvé UL

(1): MWP = 2030 psi in Übereinstimmung zur UL-Zulassung  
 (2): Ohne UL-Zertifizierung

**RUBINETTI A SFERA DI ACCIAIO INOSSIDABILE**  
**STAINLESS STEEL BALL VALVES**  
**VANNES A BOISSEAU SPHÉRIQUE EN ACIER INOXYDABLE**  
**EDELSTAHLKUGELVENTILE**

Disegno Drawing Dessin Zeichnung	N° catalogo Part number N° Catalogue Katalog Nr		Attacchi Connections Raccords Anschlüsse	Foro Sfera Ø Ball port Ø Orifice bille Ø Bohrung Ø	Kv [m³/h]	PS [bar]	TS [°C]		Confezione n° pz Package pcs Emballage Verpackung
			W	[mm]			min.	max.	
			Ø [mm]						
	NEW	6588E/M10	10	10	3	150	-40	+150	25
	NEW	6588E/M12	12		5				
	NEW	6588E/M16	16	15	17				16
	NEW	6588E/M18	18		17				
	NEW	6588E/M22	22	19	29				15
	NEW	6588E/M28	28	25	51				8

Disponibilità da concordare con ufficio commerciale CASTEL

Availability to be agreed with CASTEL sales office

Disponibilité à convenir avec le bureau de vente CASTEL

Verfügbarkeit mit CASTEL-Verkaufsbüro zu vereinbaren

**RUBINETTI A SFERA DI ACCIAIO INOSSIDABILE, CON ATTACCO DI CARICA**  
**STAINLESS STEEL BALL VALVES, WITH ACCESS FITTING**  
**VANNES A BOISSEAU SPHÉRIQUE EN ACIER INOXYDABLE, AVEC RACCORD DE CHARGE**  
**EDELSTAHLKUGELVENTILE MIT SCHRADER**

Disegno Drawing Dessin Zeichnung	N° catalogo Part number N° Catalogue Katalog Nr		Attacchi Connections Raccords Anschlüsse	Foro Sfera Ø Ball port Ø Orifice bille Ø Bohrung Ø	Kv [m³/h]	PS [bar]	TS [°C]		Confezione n° pz Package pcs Emballage Verpackung
			W	[mm]			min.	max.	
			Ø [mm]						
	NEW	6588E/M10A	10	10	3	150	-40	+150	25
	NEW	6588E/M12A	12		5				
	NEW	6588E/M16A	16	15	17				16
	NEW	6588E/M18A	18		17				
	NEW	6588E/M22A	22	19	29				15
	NEW	6588E/M28A	28	25	51				8

Disponibilità da concordare con ufficio commerciale CASTEL

Availability to be agreed with CASTEL sales office

Disponibilité à convenir avec le bureau de vente CASTEL

Verfügbarkeit mit CASTEL-Verkaufsbüro zu vereinbaren

**RUBINETTI A 3-VIE MANUALI**  
**3-WAY MANUAL VALVES**  
**VANNES MANUELLES À 3 VOIES**  
**3-WEGE-HANDVENTILE**

Disegno Drawing Dessin Zeichnung	N° catalogo Part number N° Catalogue Katalog Nr	Attacchi Connections Raccords Anschlüsse			Foro Sfera Ø Ball port Ø Orifice bille Ø Bohrung Ø [mm]	Kv [m³/h]	PS [bar]	TS [°C]		Confezione n° pz Package pcs Emballage Verpackung
		ODS		W				min.	max.	
		Ø [in.]	Ø [mm]							

Con attacchi ods di rame / With copper ods connections / Avec connexion cuivre ods / Mit lötlanschluss in kupferausführung

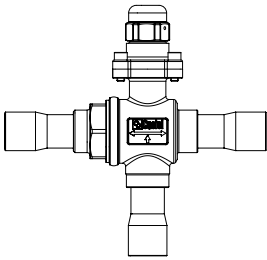
	6690E/7	7/8"	22	-	19	10,7	80	-40	+150	1
	6690E/M28	-	28	-	24	15,9				
	6690E/9	1.1/8"	-	-	24	15,9				
	6690E/11	1.3/8"	35	-	28	20,3				
	6690E/13	1.5/8"	-	-	37	38,5				
	6690E/M42	-	42	-	37	38,5				

Con attacchi ods di rame rinforzato (k65) / With reinforced copper ods connections (k65) / Avec connexion cuivre ods renforcées (k65) / Mit lötlanschluss in kupferausführung (k65)

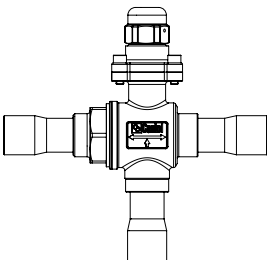
	6697E/7	7/8"	22	-	19	10,7	120	-40	+150	1
	6697E/9	1.1/8"	-	-	24	15,9				
	6697E/11	1.3/8"	35	-	28	20,3				
	6697E/13	1.5/8"	-	-	37	38,5				

Con attacchi d'acciaio inossidabile / With stainless steel connections / Avec connexion en acier inoxydable / Mit anschlüssen aus rostfreiem stahl

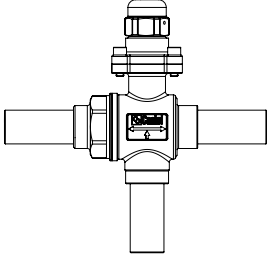
	6698E/M22	-	-	22	19	10,7	140	-40	+150	1
	6698E/M28	-	-	28	24	15,9				
	6698E/M35	-	-	35	28	20,3				
	6698E/M42	-	-	42	37	38,5				

**RUBINETTI A 3-VIE DA MOTORIZZARE**  
**3-WAYS VALVES TO BE MOTORIZED**  
**VANNES À 3 VOIES À MOTORISER**  
**3-WEGE-VENTILE, DIE MOTORISIERT WERDEN**

Disegno Drawing Dessin Zeichnung	N° catalogo Part number N° Catalogue Katalog Nr (1)	Attacchi Connections Raccords Anschlüsse			Foro Sfera Ø Ball port Ø Orifice bille Ø Bohrung Ø	Kv [m³/h]	PS [bar]	TS [°C]		Confezione n° pz Package pcs Emballage Verpackung
		ODS		W				min.	max.	
		Ø [in.]	Ø [mm]	Ø [mm]	[mm]					

Con attacchi ods di rame / With copper ods connections / Avec connexion cuivre ods / Mit lötlanschluss in kupferausführung

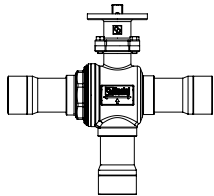
	NEW	6690EB/7	7/8"	22	-	19	10,7	80	-40	+150	1
	NEW	6690EB/M28	-	28	-	24	15,9				
	NEW	6690EB/9	1.1/8"	-	-	24	15,9				
	NEW	6690EB/11	1.3/8"	35	-	28	20,3				
	NEW	6690EB/13	1.5/8"	-	-	37	38,5				
	NEW	6690EB/M42	-	42	-	37	38,5				

Con attacchi ods di rame rinforzato (k65) / with reinforced copper ods connections (k65) / avec connexion cuivre ods renforcées (k65) / Mit lötlanschluss in kupferausführung (k65)

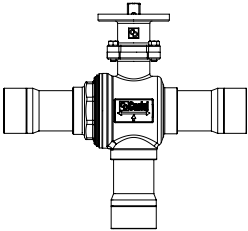
	NEW	6697EB/7	7/8"	22	-	19	10,7	120	-40	+150	1
	NEW	6697EB/9	1.1/8"	-	-	24	15,9				
	NEW	6697EB/11	1.3/8"	35	-	28	20,3				
	NEW	6697EB/13	1.5/8"	-	-	37	38,5				

Con attacchi d'acciaio inossidabile / with stainless steel connections / avec connexion en acier inoxydable / mit anschlüssen aus rostfreiem stahl

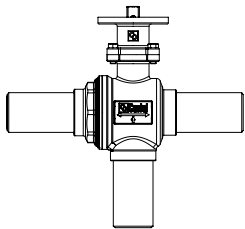
	NEW	6698EB/M22	-	-	22	19	10,7	140	-40	+150	1
	NEW	6698EB/M28	-	-	28	24	15,9				
	NEW	6698EB/M35	-	-	35	28	20,3				
	NEW	6698EB/M42	-	-	42	37	38,5				

(1): completo di adattatore per servomotore BELIMO

(1): with adapter for BELIMO actuator

(1): avec adaptateur pour servomoteur BELIMO

(1): mit Adapter für BELIMO-Antrieb

**RUBINETTI A SFERA A 3-VIE MOTORIZZATI**  
**3-WAY MOTORIZED BALL VALVES**  
**VANNES À BOISSEAU SPHÉRIQUE MOTORISÉ 3 VOIES**  
**3-WEGE MOTORKUGELABSPERRVENTILE**



Disegno Drawing Dessin Zeichnung	N° catalogo Part number N° catalogue Katalog Nr. (1)	Attacchi Connections Raccords Anschlüsse		Coppia Torque Couple Drehmoment [Nm]	Tempo di marcia Running time Durée de course Laufzeit [sec]	Potenza Power Puissance Leistung [W]	Foro Sfera Ø Ball port Ø Orifice bille Ø Bohrung Ø [mm]	Kv [m³/h]	PS [bar]	TS [°C]		Confezione n° pz Package pcs Emballage Verpackung
		ODS								min	max	
		Ø [in.]	Ø [mm]									

Con attacchi ods di rame / with copper ods connections / avec connexion cuivre ods / mit lötlanschluss in kupferausführung

	6690EM/7A2 (2)	7/8"	22	10	60	4,8	19	10,7	80	-40	+150	1
	6690EM/7A6 (3)					2,9						
	6690EM/M28A2 (2)	-	28	10	60	4,8	24	15,9				
	6690EM/M28A6 (3)					2,9						
	6690EM/9A2 (2)	1.1/8"	-	10	60	4,8	24	15,9				
	6690EM/9A6 (3)					2,9						
	6690EM/11A2 (2)	1.3/8"	35	30	120	2,4	28	20,3	80	-40	+150	1
	6690EM/11A6 (3)					3,7						
	6690EM/13A2 (2)	1.5/8"	-	30	120	2,4	37	38,5				
	6690EM/13A6 (3)					3,7						
	6690EM/M42A2 (2)	-	42	30	120	2,4	37	38,5				
	6690EM/M42A6 (3)					3,7						

Con attacchi ods di rame rinforzato (k65) / with reinforced copper ods connections (k65) / avec connexion cuivre ods renforcées (k65) / Mit lötlanschluss in kupferausführung (k65)

	6697EM/7A2 (2)	7/8"	22	10	60	4,8	19	10,7	120	-40	+150	1
	6697EM/7A6 (3)					2,9						
	6697EM/9A2 (2)	1.1/8"	-	10	60	4,8	24	15,9				
	6697EM/9A6 (3)					2,9						
	6697EM/11A2 (2)	1.3/8"	35	30	120	2,4	28	20,3	120	-40	+150	1
	6697EM/11A6 (3)					3,7						
	6697EM/13A2 (2)	1.5/8"	-	30	120	2,4	37	38,5				
	6697EM/13A6 (3)					3,7						

(1) completo di attuatore e piastra di montaggio

(2)  
 - Tensione = 24 V  
 - Frequenza = 50/60 Hz  
 - Grado di protezione = IP 54  
 - Angolo di manovra = 90°  
 - Connessioni elettriche: uscita in commutazione a 2 punti (aperto/chiuso) oppure uscita in continua (0 ÷ 10V)

(3)  
 - Tensione = 230 V  
 - Frequenza = 50/60 Hz  
 - Grado di protezione = IP 43  
 - Angolo di manovra = 90°  
 - Connessioni elettriche: uscita in commutazione a 2 punti (aperto/chiuso)

(1) with actuator and mounting plate

(2)  
 - Voltage = 24 V  
 - Frequency = 50/60 Hz  
 - Degree of protection = IP 54  
 - Rotation angle = 90°  
 - Wiring connections : switching output 2 points (open/close) or continuous output (0 ÷ 10V)

(3)  
 - Voltage = 230 V  
 - Frequency = 50/60 Hz  
 - Degree of protection = IP 43  
 - Rotation angle = 90°  
 - Wiring connections : switching output 2 points (open/close)

(1) avec servomoteur et la plaque de montage

(2)  
 - Tension = 24 v  
 - Fréquence = 50/60 Hz  
 - Degré de protection = IP 54  
 - Angle de rotation = 90°  
 - Connexions électriques : sortie à contacts à 2 points (ouvert/fermé) ou sortie progressive (0 ÷ 10V)

(3)  
 - Tension = 230 V  
 - Fréquence = 50/60 Hz  
 - Degré de protection = IP 43  
 - Angle de rotation = 90°  
 - Connexions électriques : sortie à contacts à 2 points (ouvert/fermé)

(1) mit Stellantrieb und Montageplatte

(2)  
 - Spannung = 24 V  
 - Frequenz = 50/60 Hz  
 - Schutzgrad = IP 54  
 - Drehwinkel = 90°  
 - Anschlussplan : Schaltendem Ausgang 2 Punkt (offen/geschlossen) oder Stetigem Ausgang (0 ÷ 10V)

(3)  
 - Spannung = 230 V  
 - Frequenz = 50/60 Hz  
 - Schutzgrad = IP 43  
 - Drehwinkel = 90°  
 - Anschlussplan : Schaltendem Ausgang 2 Punkt (offen/geschlossen)

**RUBINETTI A SFERA A 3-VIE MOTORIZZATI**  
**3-WAY MOTORIZED BALL VALVES**  
**VANNES À BOISSEAU SPHÉRIQUE MOTORISÉ 3 VOIES**  
**3-WEGE MOTORKUGELABSPERRVENTILE**



Disegno Drawing Dessin Zeichnung	N° catalogo Part number N° catalogue Katalog Nr. (1)	Attacchi Connections Raccords Anschlüsse	Coppia Torque Couple Drehmoment [Nm]	Tempo di marcia Running time Durée de course Laufzeit [sec]	Potenza Power Puissance Leistung [W]	Foro Sfera Ø Ball port Ø Orifice bille Ø Bohrung Ø [mm]	Kv [m <sup>3</sup> /h]	PS [bar]	TS [°C]		Confezione n° pz Package pcs Emballage Verpackung
		ODS							min	max	
		Ø [mm]									

Con attacchi d'acciaio inossidabile / with stainless steel connections / avec connexion en acier inoxydable / mit anschlüssen aus rostfreiem stahl

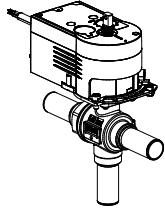
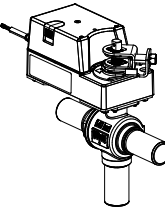
	6698EM/M22A2 (2)	22	10	60	4,8	19	10,7	140	-40	+150	1
	6698EM/M22A6 (3)				2,9						
	6698EM/M28A2 (2)	28	10	60	4,8	24	15,9				
	6698EM/M28A6 (3)				2,9						
	6698EM/M35A2 (2)	35	30	120	2,4	28	20,3	140	-40	+150	1
	6698EM/M35A6 (3)				3,7						
	6698EM/M42A2 (2)	42	30	120	2,4	37	38,5				
	6698EM/M42A6 (3)				3,7						

(1) completo di attuatore e piastra di montaggio

(2)  
 - Tensione = 24 V  
 - Frequenza = 50/60 Hz  
 - Grado di protezione = IP 54  
 - Angolo di manovra = 90 °  
 - Connessioni elettriche: uscita in commutazione a 2 punti (aperto/chiuso) oppure uscita in continua (0 ÷ 10V)

(3)  
 - Tensione = 230 V  
 - Frequenza = 50/60 Hz  
 - Grado di protezione = IP 43  
 - Angolo di manovra = 90 °  
 - Connessioni elettriche: uscita in commutazione a 2 punti (aperto/chiuso)

(1) with actuator and mounting plate

(2)  
 - Voltage = 24 V  
 - Frequency = 50/60 Hz  
 - Degree of protection = IP 54  
 - Rotation angle = 90°  
 - Wiring connections : switching output 2 points (open/close) or continuous output (0 ÷ 10V)

(3)  
 - Voltage = 230 V  
 - Frequency = 50/60 Hz  
 - Degree of protection = IP 43  
 - Rotation angle = 90°  
 - Wiring connections : switching output 2 points (open/close)

(1) avec servomoteur et la plaque de montage

(2)  
 - Tension = 24 v  
 - Fréquence = 50/60 Hz  
 - Degré de protection = IP 54  
 - Angle de rotation = 90°  
 - Connexions électriques : sortie à contacts à 2 points (ouvert/fermé) ou sortie progressive (0 ÷ 10V)

(3)  
 - Tension = 230 V  
 - Fréquence = 50/60 Hz  
 - Degré de protection = IP 43  
 - Angle de rotation = 90°  
 - Connexions électriques : sortie à contacts à 2 points (ouvert/fermé)

(1) mit Stellantrieb und Montageplatte

(2)  
 - Spannung = 24 V  
 - Frequenz = 50/60 Hz  
 - Schutzgrad = IP 54  
 - Drehwinkel = 90°  
 - Anschlussplan : Schaltendem Ausgang 2 Punkt (offen/geschlossen) oder Stetigem Ausgang (0 ÷ 10V)

(3)  
 - Spannung = 230 V  
 - Frequenz = 50/60 Hz  
 - Schutzgrad = IP 43  
 - Drehwinkel = 90°  
 - Anschlussplan : Schaltendem Ausgang 2 Punkt (offen/geschlossen)

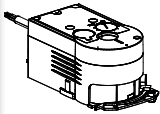
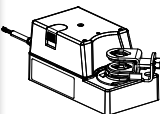
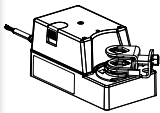
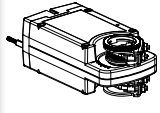
Disegno Drawing Dessin Zeichnung	N° catalogo Part number N° Catalogue Katalog Nr	Tensione Voltage Tension Spannung	Frequenza Frequency Fréquence Frequenz	Potenza Power Puissance Leistung	Grado di protezione Degree of protection Degrè de protection Schutzgrad	Adatto per rubinetto Designed for valve Adapté pour vanne Passed für ventil	Angolo di manovra Rotation angle Angle de rotation Drehwinkel	Coppia Torque Couple Drehmoment	Tempo di marcia Running time Durée de course Laufzeit	Temperatura ambiente Ambient temperature Température ambiante Umgebungstemperatur		Confezione n° pz Package Pcs. Emballage Verpackung
		[°C]										
		[V]	[Hz]	[W]						min	Max	
	9700/RA2 (1)	24	50/60	4,8	IP 54	6570EL/M6; 6570EL/2; 6570EL/3; 6570EL/M10; 6570EL/M12; 6570EL/4; 6570EL/5; 6570EL/M18; 6570EL/6; 6570EL/7; 6570EL/9; 6570EL/M28  6570E/M6; 6570E/M6A; 6570E/2; 6570E/2A; 6570E/3; 6570E/3A; 6570E/M10; 6570E/M10A; 6570E/M12; 6570E/M12A; 6570E/4; 6570E/4A; 6570E/5; 6570E/5A; 6570E/M18; 6570E/M18A; 6570E/6; 6570E/6A; 6570E/7; 6570E/7A; 6570E/9; 6570E/9A; 6570E/M28; 6570E/M28A  6577E/2; 6577E/3; 6577E/4; 6577E/5; 6577E/6; 6577E/7  6578E/M6; 6578E/M10; 6578E/M12; 6578E/M16; 6578E/M18; 6578E/M22  6588E/M10; 6588E/M10A; 6588E/M12; 6588E/M12A; 6588E/M16; 6588E/M16A; 6588E/M18; 6588E/M18A; 6588E/M22; 6588E/M22A	90°	10	60	-20	+50	1
	9700/RA6 (2)	230	50/60	2,9	IP 43	6570EL/7; 6570EL/9; 6570EL/M28  6570E/7; 6570E/7A; 6570E/9; 6570E/9A; 6570E/M28; 6570E/M28A  6577E/7 6578E/M22 6588E/M22; 6588E/M22A						
	9720/RA2 (1)	24	50/60	2,4	IP 54	6570EL/11; 6570EL/13; 6570EL/M42  6570E/11; 6570E/11A; 6570E/13; 6570E/13A; 6570E/M42; 6570E/M42A;  6577E/9; 6577E/11; 6577E/13;  6578E/M28; 6578E/M35; 6578E/M42; 6578E/M48; 6588E/M28; 6588E/M28A	90°	30	120	-20	+50	1
	9720/RA6 (2)	230	50/60	3,7	IP 43							
	9730/RA2 (3)	24	50/60	9	IP 54	6570EL/17 6570E/17; 6570E/17A 6577E/17 6578E/M60	90°	60	150	-30	+50	1
	9730/RA6 (2)	230	50/60	9	IP 54							

(1) Connessioni elettriche: uscita in commutazione a 2 punti (aperto/chiuso) oppure uscita in continua (0 ÷ 10V)

(2) Connessioni elettriche: uscita in commutazione a 2 punti (aperto/chiuso)

(3) Connessioni elettriche: uscita in continua (0 ÷ 10V)

(1) Wiring connections: switching output 2 points (open/close) or continuous output (0 ÷ 10V)

(2) Wiring connections: switching output 2 points (open/close)

(3) Wiring connections: continuous output (0 ÷ 10V)

(1) Connexions électriques: sortie à contacts à 2 points (ouvert/fermé) ou sortie progressive (0 ÷ 10V)

(2) Connexions électriques: sortie à contacts à 2 points (ouvert/fermé)

(3) Connexions électriques: sortie progressive (0 ÷ 10V)

(1) Anschlussplan: Schaltendem Ausgang 2 Punkt (offen/geschlossen) oder Stetigem Ausgang (0 ÷ 10V)

(2) Anschlussplan: Schaltendem Ausgang 2 Punkt (offen/geschlossen)

(3) Anschlussplan: Stetigem Ausgang (0 ÷ 10V)



**CONTATTI AUSILIARI**  
**AUXILIARY SWITCH UNITS**  
**UNITÉ D'INTERRUPTEURS AUXILIAIRES**  
**HILFSSCHALTEREINHEIT**

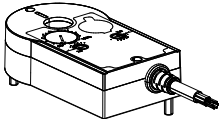
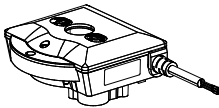

Disegno Drawing Dessin Zeichnung	N° catalogo Part number N° catalogue Katalog Nr.	Adatto per attuatore Designed for actuator Adaptée pour servomoteur Passed für stellantrieb	Tipo contatto Contact type Type contact Kontakt Typ [Nm]	Carico massimo Max loading Charge maximale Belastung [A]	Temperatura ambiente Ambient temperature Température ambiante Umgebungstemperatur [°C]		Grado di protezione Degree of protection Degré de protection Schutzgrad	Confezione n° pz Package pcs Emballage Verpackung
					Min	Max		
	9750/X01	9700/RA2	Doppio Double Double Dopplet	5	-20	+55	IP 40	1
	9750/X02	9700/RA6 9720/RA2 9720/RA6	Doppio Double Double Dopplet	5	-20	+55	IP 4	1

**ADATTATORI PER ATTUATORE  
SERVOMOTOR ADAPTERS  
ADAPTEURS POUR SERVOMOTEUR  
LOETADAPTERS FÜR STELLANTRIEB**



Disegno Drawing Dessin Zeichnung	N° catalogo Part number N° Catalogue Katalog Nr	Adatto per rubinetto Designed for valve Adaptée pour vanne Passed für ventil	Adatto per attuatore Designed for actuator Adaptée pour servomoteur Passed für stellantrieb	Confezione n° pz Package Pcs. Emballage Verpackung
	NEW 9901/X58	6570EL/M6; 6570EL/2; 6570EL/3; 6570EL/M10; 6570EL/M12; 6570EL/4; 6570EL/5; 6570EL/M18; 6570EL/6  6570E/M6; 6570E/M6A; 6570E/2; 6570E/2A; 6570E/3; 6570E/3A; 6570E/M10; 6570E/M10A; 6570E/M12; 6570E/M12A; 6570E/4; 6570E/4A; 6570E/5; 6570E/5A; 6570E/M18; 6570E/M18A; 6570E/6; 6570E/6A  6577E/2; 6577E/3; 6577E/4; 6577E/5; 6577E/6  6578E/M6; 6578E/M10; 6578E/M12; 6578E/M16; 6578E/M18  6588E/M10; 6588E/M10A; 6588E/M12; 6588E/M12A; 6588E/M16; 6588E/M16A; 6588E/M18; 6588E/M18A	9700/RA2	1
	NEW 9901/X60	6570EL/7; 6570EL/9; 6570EL/M28  6570E/7; 6570E/7A; 6570E/9; 6570E/9A; 6570E/M28; 6570E/M28A  6588E/M22; 6588E/M22A; 6588E/M28; 6588E/M28A		
	NEW 9901/X57	6570EL/7; 6570EL/9; 6570EL/M28  6570E/7; 6570E/7A; 6570E/9; 6570E/9A; 6570E/M28; 6570E/M28A  6588E/M22; 6588E/M22A; 6588E/M28; 6588E/M28A	9700/RA6	1
	NEW 9901/X73	6577E/7; 6578E/M22	9700/RA2	1
	NEW 9901/X74	6577E/7 6578E/M22	9700/RA6	1
		6577E/9 6578E/M28	9720/RA2 - 9720/RA6	
	NEW 9901/X75	6570EL/11; 6570EL/13; 6570EL/M42  6570E/11; 6570E/11A; 6570E/13; 6570E/13A; 6570E/M42; 6570E/M42A  6577E/11; 6577E/13  6578E/M35; 6578E/M42; 6578E/M48	9720/RA2 - 9720/RA6	1
	NEW 9901/X76	6570EL/17  6570E/17; 6570E/17A  6577E/17  6578E/M60	9730/RA2 - 9730/RA6	1

**ANTIVIBRANTI, ATTACCHI ACCIAIO INOX**  
**VIBRATION ABSORBERS, STAINLESS STEEL CONNECTIONS**  
**ÉLIMINATEURS DE VIBRATIONS, CONNEXIONS EN ACIER INOXYDABLE**  
**SCHWINGUNGSDÄMPFER, EDELSTAHLVERBINDUNGEN**

Disegno Drawing Dessin Zeichnung	N° catalogo Part number N° Catalogue Katalog Nr		Attacchi Connections Raccords Anschlüsse		PS [bar]			Confezione n° pezzi Package pcs Emballage Verpackung			
			ODS		TS [°C] -80 / +100	TS [°C] +120	TS [°C] +140				
			Ø [in.]	Ø [mm]							
	NEW	7690N/3	3/8"	-	50	49	48	100			
	NEW	7690N/M10	-	10							
	NEW	7690N/M12	-	12							
	NEW	7690N/4	1/2"	-							
	NEW	7690N/M15	-	15				50	49	48	50
	NEW	7690N/5	5/8"	16							
	NEW	7690N/M18	-	18							
	NEW	7690N/6	3/4"	-				50	49	48	25
	NEW	7690N/7	7/8"	22							
	NEW	7690N/M28	-	28							
	NEW	7690N/9	1.1/8"	-				50	49	48	10
	NEW	7690N/11	1.3/8"	35							
	NEW	7690N/13	1.5/8"	-							
	NEW	7690N/M42	-	42				50	49	48	5
	NEW	7690N/17	2.1/8"	54							

(#)

Per applicazioni specifiche con fluidi refrigeranti non elencati sopra, pregò contattare l'Ufficio Tecnico della Castel

For specific applications with refrigerant fluids not listed above, please contact Castel Technical Department

Pour des applications spécifiques avec des fluides frigorigènes non énumérés ci-dessus, s'il vous plaît contacter le service technique de la Castel

Für spezielle Anwendungen mit Kältemitteln nicht oben aufgeführt sind, kontaktieren Sie bitte Castel Technische Abteilung

P  L Y H E D R A

REFRIGERANTI A1 - A2L - A3, ASHRAE STANDARD 34-2019<sup>(#)</sup>  
A1 - A2L - A3 REFRIGERANTS, ASHRAE STANDARD 34-2019<sup>(#)</sup>  
RÉFRIGÉRANTS A1 - A2L - A3, ASHRAE STANDARD 34-2019<sup>(#)</sup>  
A1 - A2L - A3 KALTEMITTEL, ASHRAE STANDARD 34-2019<sup>(#)</sup>

HFC (R134A, R32, R404A, R407C, R410A, R507)  
HFO (R1234YF, R1234ZE)  
HFO + HFC (R448A, R449A, R450A, R452A, R452B, R454A,  
R454B, R454C, R455A, R513A)  
HC (R290, R600, R600A, R1270)

 **Castel**<sup>®</sup>  
Italian technology



**VALVOLE D'ESPANSIONE A SOLENOIDE CON ORIFIZIO INTERCAMBIABILE**  
**SOLENOID EXPANSION VALVES WITH INTERCHANGEABLE ORIFICE**  
**DÉTENDEURS À COMMANDE ÉLECTRIQUES AVEC ENSEMBLE ORICE INTERCHANGEABLE**  
**ELEKTRISCHE EXPANSIONSVENTILE MIT AUSTAUSCHBAREM DUESENEINSATZ**



POLYHEDRA

Disegno Drawing Dessin Zeichnung	N° catalogo Part number N° Catalogue Katalog Nr	Tipo orificio Orifice type Type d'orifice Düseneinsatz Typ	Attacchi Connections Raccords Anschlüsse				Kv [m³/h]	PS [bar]	TS [°C]		Confezione n° pz Package pcs. Emballage Verpackung
			In		Out				Min	Max	
			Ø [in.]	Ø [mm]	Ø [in.]	Ø [mm]					
	2028N/3S01	01	3/8"	-	1/2"	-	0,010	50	-40	+100	17
	2028N/M10S01		-	10	-	12					
	2028N/3S02	02	3/8"	-	1/2"	-	0,017				
	2028N/M10S02		-	10	-	12					
	2028N/3S03	03	3/8"	-	1/2"	-	0,023				
	2028N/M10S03		-	10	-	12					
	2028N/3S04	04	3/8"	-	1/2"	-	0,043				
	2028N/M10S04		-	10	-	12					
	2028N/3S05	05	3/8"	-	1/2"	-	0,065				
	2028N/M10S05		-	10	-	12					
	2028N/3S06	06	3/8"	-	1/2"	-	0,113				
	2028N/M10S06		-	10	-	12					
	2028N/4S07	07	1/2"	-	5/8"	-	0,200				
	2028N/M12S07		-	12	-	16					
	2028N/4S08	08	1/2"	-	5/8"	-	0,230				
	2028N/M12S08		-	12	-	16					
	2028N/4S09	09	1/2"	-	5/8"	-	0,250				
	2028N/M12S09		-	12	-	16					

per le potenzialità nominali vedere tabella dei gruppi orificio

for rated capacities see table of the orifice assemblies

pour les capacités nominales voir tableau des ensembles d'orifices

für Nennleistungen siehe Tabelle der Austrittsanordnungen

**VALVOLE D'ESPANSIONE A SOLENOIDE CON ORIFIZIO INTERCAMBIABILE - CONFORMITÀ ATEX PER USO IN EX ZONA 2**  
**SOLENOID EXPANSION VALVES WITH INTERCHANGEABLE ORIFICE - ATEX CONFORMITY FOR USE IN EX ZONE 2**  
**DÉTENDEURS À COMMANDE ÉLECTRIQUES AVEC ENSEMBLE ORICE INTERCHANGEABLE - CONFORMITÉ ATEX POUR UTILISATION EN ZONE EX 2**  
**ELEKTRISCHE EXPANSIONSVENTILE MIT AUSTAUSCHBAREM DÜSENEINSATZ - ATEX-KONFORMITÄT FÜR DEN EINSATZ IN EX-ZONE 2**



Disegno Drawing Dessin Zeichnung	N° catalogo Part number N° Catalogue Katalog Nr	Tipo orificio Orifice type Type d'orifice Düseneinsatz Typ	Attacchi Connections Raccords Anschlüsse				Kv [m³/h]	PS [bar]	TS [°C]		Confezione n° pz Package pcs. Emballage Verpackung
			In		Out				Min	Max	
			Ø [in.]	Ø [mm]	Ø [in.]	Ø [mm]					
	2028EX/3A601	01	3/8"	-	1/2"	-	0,010	50	-40	+100	21
	2028EX/M10A601		-	10	-	12					
	2028EX/3A602	02	3/8"	-	1/2"	-	0,017				
	2028EX/M10A602		-	10	-	12					
	2028EX/3A603	03	3/8"	-	1/2"	-	0,023				
	2028EX/M10A603		-	10	-	12					
	2028EX/3A604	04	3/8"	-	1/2"	-	0,043				
	2028EX/M10A604		-	10	-	12					
	2028EX/3A605	05	3/8"	-	1/2"	-	0,065				
	2028EX/M10A605		-	10	-	12					
	2028EX/3A606	06	3/8"	-	1/2"	-	0,113				
	2028EX/M10A606		-	10	-	12					
	2028EX/4A607	07	1/2"	-	5/8"	-	0,200				
	2028EX/M12A607		-	12	-	16					
	2028EX/4A608	08	1/2"	-	5/8"	-	0,230				
	2028EX/M12A608		-	12	-	16					
2028EX/4A609	09	1/2"	-	5/8"	-	0,250					
2028EX/M12A609		-	12	-	16						

per le potenzialità nominali vedere tabella dei gruppi orificio

for rated capacities see table of the orifice assemblies

pour les capacités nominales voir tableau des ensembles d'orifices

für Nennleistungen siehe Tabelle der Austrittsanordnungen

**GRUPPI ORIFICI**  
**ORIFICE ASSEMBLIES**  
**ENSEMBLES ORIFICE**  
**DÜSENEINSATZ**



Disegno Drawing Dessin Zeichnung	N° catalogo Part number N° Catalogue Katalog Nr	Tipo orificio Orifice type Type d'orifice Düseneinsatz Typ	Potenzialità nominali (1) Rated capacity (1) Capacités nominales (1) Nennleistungen (1) [kW]																Confezione n° pz Package pcs. Emballage Verpackung		
			R134a	R32	R404A R507	R407C	R410A	R1234ze	R1234yf	R448A	R449A	R450A	R452A	R452B	R454B	R513A	R290	R600		R600a	R1270
	9150N/R63	01	0,7	2,4	0,7	1,2	1,2	0,6	0,6	1,0	1,1	0,6	0,9	1,5	1,1	0,8	1,9	1,2	1,2	2,2	10
	9150N/R64	02	1,5	4,9	1,5	2,4	2,3	1,2	1,1	2,0	2,3	1,3	1,8	3,1	2,2	1,6	3,8	2,5	2,4	4,4	
	9150N/R65	03	1,7	5,7	1,7	2,8	2,7	1,4	1,3	2,4	2,7	1,5	2,1	3,6	2,6	1,9	4,5	2,9	2,9	5,2	
	9150N/R66	04	2,8	9,3	2,8	4,5	4,4	2,2	2,1	3,9	4,3	2,4	3,5	5,9	4,3	3,1	7,3	4,7	4,7	8,4	
	9150N/R67	05	4,8	15,9	4,8	7,7	7,5	3,8	3,7	6,6	7,4	4,1	5,9	10,1	7,3	5,3	12,4	8,1	8,0	14,4	
	9150N/R68	06	6,7	22,1	6,6	10,7	10,5	5,3	5,1	9,2	10,2	5,7	8,2	14,0	10,1	7,4	17,2	11,3	11,1	20,0	
	9150N/R69	07	10,5	34,9	10,5	16,8	16,5	8,4	8,0	14,6	16,2	9,0	13,0	22,1	16,0	11,7	27,2	17,7	17,4	31,3	
	9150N/R78	08	12,7	42,0	12,6	20,3	19,9	10,1	9,6	17,5	19,0	10,8	15,6	26,6	19,3	14,1	32,7	21,4	21,0	37,9	
	9150N/R79	09	14,1	46,5	14,0	22,5	22,1	11,2	10,7	19,4	21,6	12,0	17,3	29,4	21,4	15,6	36,3	23,7	23,3	42,0	

(1)  
 Le potenzialità nominali sono riferite a:  
 - Temperatura d'evaporazione T<sub>evap</sub> = + 5 °C  
 - Temperatura di condensazione T<sub>cond</sub> = + 32 °C  
 - Temperatura del liquido all'ingresso della valvola T<sub>liq</sub> = + 28 °C

(1)  
 Rated capacities are based on:  
 - Evaporating temperature T<sub>evap</sub> = + 5 °C  
 - Condensing temperature T<sub>cond</sub> = + 32 °C  
 - Refrigerant liquid temperature ahead of valve T<sub>liq</sub> = + 28 °C

(1)  
 Les capacités nominales se basent sur:  
 - Température d'évaporation T<sub>evap</sub> = +5 °C  
 - Température de condensation T<sub>cond</sub> = +32 °C  
 - Température du liquide frigorigène en amont du détendeur T<sub>liq</sub> = +28 °C

(1)  
 Nennleistungen basieren auf:  
 - Verdampfungstemperatur T<sub>verd</sub> = +5 °C  
 - Kondensationstemperatur T<sub>kond</sub> = +32 °C  
 - Temperatur des flüssigen Kältemittels vor dem Ventil T<sub>flü</sub> = +28 °C

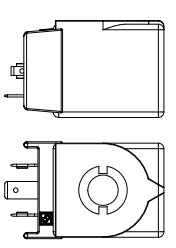
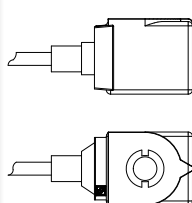
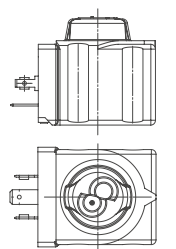
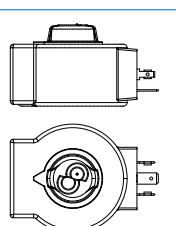

Disegno Drawing Dessin Zeichnung	Tipo Bobina Coil Type Type bobine Spulentyp	N° catalogo Part number N° Catalogue Katalog Nr	Tensione Voltage Tension Spannung	Frequenza Frequency Fréquence Frequenz	Potenza Power Puissance Leistung	Connettori Connections Raccordeme Anschlüsse		Note Note Notes Hinweise	Lunghezza cavo Cable length Longueur du câble Kabellänge [m]	Confezione n° pz Package Pcs. Emballage Verpackung	
			[V]	[Hz]	[W]	Grado di protezione Degree of protection Degré de protection Schutz - Klasse					
						IP 65	IP 68				
	HM2 (1)	9100EX/RA2	24	50/60	8	9150EX/ R02	-	Omologazione ATEX per uso in EX zona 2 ATEX approval for use in EX Zone 2 Homologation ATEX pour utilisation en zone Ex 2 ATEX-Zulassung für den Einsatz in EX-Zone 2	-	90	
		9100EX/RA4	110							90	
		9100EX/RA6	220/230							90	
		9100EX/RA7	240							90	
	CM2 (1)	9110EX/RA2	24	50/60	8	-	-	Omologazione ATEX per uso in EX zona 2 ATEX approval for use in EX Zone 2 Homologation ATEX pour utilisation en zone Ex 2 ATEX-Zulassung für den Einsatz in EX-Zone 2	1	8	
		9110EX/RA4	110							8	
		9110EX/RA6	220/230							8	
		9110EX/RA7	240							8	
	HF4	NEW 9360/RA2	24	50/60	8	9150/R02 9900/X66	9155/ R01 9155/ R02	-	-	45	
		NEW 9360/RA4	110/120							45	
		NEW 9360/RA6	220/230							45	
		NEW 9360/RA7	240							45	
		NEW 9360/RD1	12 D.C.							17	45
		NEW 9360/RD2	24 D.C.							15,5	45
	HF3	9320/RA6	220/230	50/60	12	9150/R02 9900/X66	-	-	-	18	
		9320/RD1	12 D.C.	-	20					18	
		9320/RD2	24 D.C.	-	20					18	

(1)  
bobina dotata di ricambio G9151/R14

Bobine 9160/... in esaurimento scorte

(1)  
coil with spare part G9151/R14

Coils 9160/.. running out of stock

(1)  
Bobine avec remplacement G9151/R14

Bobines 9160/... en épuisement du stock

(1)  
Spule mit Ersatz G9151/R14 ausgestattet

Spulen 9160/.. bis zum Ende der Vorräte  
erhältlich

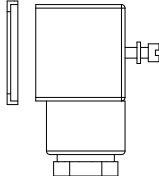
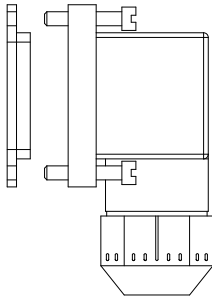
Disegno Drawing Dessin Zeichnung	N° Catalogo Part number N° Catalogue Katalog Nr	Grado di protezione Degree of protection Degrè de protection Schutz - klasse	Lunghezza cavo Cable length Longueur du câble Kabellänge [m]	Note Note Notes Hinweise	Confezione n° pz Package pcs Emballage Verpackung
	9150EX/R02	IP 65	-	Omologazione ATEX per uso in EX zona 2 ATEX approval for use in EX Zone 2 Homologation ATEX pour utilisation en zone Ex 2 ATEX-Zulassung für den Einsatz in EX-Zone 2	240
	9150/R02	IP 65	-	-	240
	9900/X66		1	-	100
	9155/R01	IP 65 / IP 68	-	-	120
	9155/R02		1	-	1

**VALVOLE D'ESPANSIONE ELETTRONICHE**  
**ELECTRONIC EXPANSION VALVES**  
**DÉTENDEURS ÉLECTRONIQUES**  
**ELEKTRONISCHE EXPANSIONSVENTILE**



POLYHEDRA

Disegno Drawing Dessin Zeichnung	N° Catalogo Part Number N° Catalogue Katalog Nr	Attacchi Connections Raccords Anschlüsse				PS [bar]	TS [°C]		Tensione Voltage Tension Spannung [V]	Potenza Power Puissance Leistung [W]	Passi Steps Pas Schritte	Grado di protezione Degree of protection Degrè de protection Schutz - klasse	Confezione n° pz Package Pcs. Emballage Verpackung
		In		Out			Min	Max					
		Ø [in.]	Ø [mm]	Ø [in.]	Ø [mm]								
	NEW 27115/3	3/8"	3/8"	-	-	50	-40	+60	6	2,4	415		
	NEW 27115/M10	-	-	10	10								
	NEW 27115/M12	-	-	12	12								
	NEW 27115/4	1/2"	1/2"	-	-								
	NEW 27120/3	3/8"	3/8"	-	-								
	NEW 27120/M10	-	-	10	10								
	NEW 27120/M12	-	-	12	12								
	NEW 27120/4	1/2"	1/2"	-	-								
	NEW 27127/3	3/8"	3/8"	-	-								
	NEW 27127/M10	-	-	10	10								
	NEW 27127/M12	-	-	12	12								
	NEW 27127/4	1/2"	1/2"	-	-								
	NEW 27232/M12	-	-	12	12	50	-40	+60	9	5,4	415	IP65	1
	NEW 27232/4	1/2"	1/2"	-	-								
	NEW 27232/5	5/8"	5/8"	16	16								
	NEW 27232/7	7/8"	7/8"	22	22								
	NEW 27236/M12	-	-	12	12								
	NEW 27236/4	1/2"	1/2"	-	-								
	NEW 27236/5	5/8"	5/8"	16	16								
	NEW 27236/7	7/8"	7/8"	22	22								
	NEW 27340/7	7/8"	7/8"	22	22	50	-40	+60	9	5,4	415	IP65	1
	NEW 27340/9	1.1/8"	1.1/8"	-	-								
	NEW 27344/7	7/8"	7/8"	22	22								
	NEW 27344/9	1.1/8"	1.1/8"	-	-								

Motore passo-passo bipolare a magneti permanenti | Bipolar stepper motor with permanent magnets | Moteur pas à pas bipolaire à aimants permanents | Bipolarer Schrittmotor mit Permanentmagneten

**VALVOLE D'ESPANSIONE ELETTRONICHE**  
**ELECTRONIC EXPANSION VALVES**  
**DÉTENDEURS ÉLECTRONIQUES**  
**ELEKTRONISCHE EXPANSIONSVENTILE**



N° Catalogo Part Number N° Catalogue Katalog Nr	Potenzialità nominali (1) Rated capacities (1) Capacités nominales (1) Nennleistungen (1) [kW]																		
	R134a	R32	R404A	R407C	R410A	R507A	R1234yf	R1234ze	R448A	R449A	R450A	R452A	R452B	R454B	R513A	R290	R600	R600a	R1270
27115/--	15,30	33,94	14,37	19,92	23,40	14,02	11,28	12,02	19,07	18,71	13,43	14,78	26,38	26,65	12,98	20,61	13,08	13,53	23,07
27120/--	20,40	45,26	19,16	26,56	31,20	18,70	15,04	16,02	25,42	24,95	17,90	19,71	35,18	35,53	17,30	27,48	17,44	18,03	30,75
27127/--	25,20	55,91	23,67	32,81	38,54	23,09	18,57	19,79	31,41	30,82	22,11	24,35	43,45	43,89	21,37	33,94	21,55	22,28	38,00
27232/--	32,20	71,44	30,24	41,92	49,24	29,51	23,73	25,29	40,13	39,38	28,26	31,11	55,52	56,09	27,31	43,37	27,53	28,47	48,54
27236/--	44,10	97,84	41,42	57,42	67,44	40,42	32,51	34,64	54,96	53,93	38,70	42,61	76,04	76,81	37,40	59,40	37,71	39,00	66,48
27340/--	51,00	113,15	47,90	66,40	78,00	46,74	37,59	40,00	63,56	62,37	44,75	49,28	87,94	88,83	43,25	68,69	43,61	45,09	76,89
27344/--	59,32	131,60	55,71	77,24	90,72	54,36	43,72	46,59	73,93	72,54	52,05	57,32	102,29	103,32	50,31	79,89	50,72	52,44	89,43

(1)  
 Potenzialità nominale a valvola tutta aperta e flusso del liquido dall'attacco laterale verso l'attacco assiale.  
 Le potenzialità nominali sono riferite a:  
 - Temperatura d'evaporazione T<sub>evap</sub> = + 5 °C  
 - Temperatura di condensazione T<sub>cond</sub> = + 32 °C  
 - Temperatura del liquido all'ingresso della valvola T<sub>liq</sub> = + 28 °C  
**Intervallo d'utilizzo delle valvole dal 10% al 95% delle potenzialità nominali dichiarate**

(1)  
 Rated capacity with fully open valve and liquid flow from radial to axial connection.  
 Rated capacities are based on:  
 - Evaporating temperature T<sub>evap</sub> = + 5 °C  
 - Condensing temperature T<sub>cond</sub> = + 32 °C  
 - Refrigerant liquid temperature ahead of valve T<sub>liq</sub> = + 28 °C  
**Valves operating range from 10% up to 95% of declared nominal capacities**

(1)  
 Capacité nominale avec vanne complètement ouverte et écoulement de liquide d'un raccordement radial à axial.  
 Les capacités nominales se basent sur :  
 - Température d'évaporation T<sub>evap</sub> = +5 °C  
 - Température de condensation T<sub>cond</sub> = +32 °C  
 - Température du liquide frigorigène en amont du détendeur T<sub>liq</sub> = +28 °C  
**Plage de fonctionnement des vannes de 10% à 95% des capacités nominales déclarées**

(1)  
 Nennkapazität bei vollständig geöffnetem Ventil und Flüssigkeitsfluss von radialem zu axialem Anschluss.  
 Nennleistungen basieren auf:  
 - Verdampfungstemperatur T<sub>verd</sub> = +5 °C  
 - Kondensationstemperatur T<sub>kond</sub> = +32 °C  
 - Temperatur des flüssigen Kältemittels vor dem Ventil T<sub>flü</sub> = +28 °C  
**Der Ventilbetrieb reicht von 10% bis zu 95% der angegebenen Nennleistungen**

**CONNETTORI**  
**CONNECTORS**  
**CONNECTEURS**  
**STECKER**

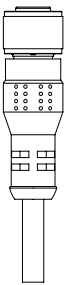

Disegno Drawing Dessin Zeichnung	N° Catalogo Part number N° Catalogue Katalog Nr	Grado di protezione Degree of protection Degrè de protection Schutz - klasse	Lunghezza cavo Cable length Longueur du câble Kabellänge [m]	Note Note Notes Hinweise	Confezione n° pz Package pcs Emballage Verpackung
	9901/X08	IP 65	3	Connettore circolare M12 M12 circular connector Connecteur circulaire M12 Rundsteckverbinder M12	1
	9901/X20		15		

**VALVOLE SOLENOIDE N.C. ATTACCHI SAE FLARE SENZA BOBINA**  
**N.C. SOLENOID VALVES SAE FLARE CONNECTIONS WITHOUT COILS**  
**VANNES ELECTROMAGNETIQUES N.F. SAE FLARE RACCORDS SANS BOBINE**  
**N.G. MAGNETVENTILE MIT BOERDELANSCHLUSS OHNE SPULE**

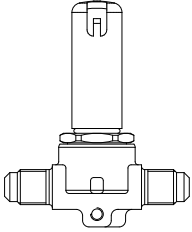
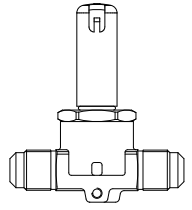
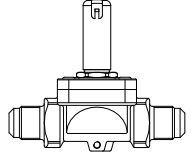
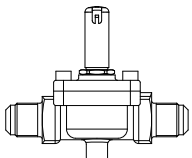
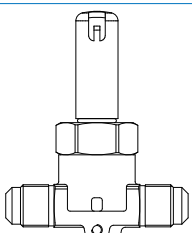
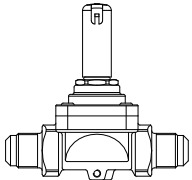
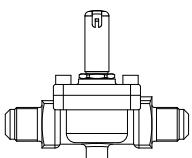
Principio di funzionamento Operating principle Principe de fonctionnement Funtionsprinzip	Disegno Drawing Dessin Zeichnung	N° Catalogo Part Number N° Catalogue Katalog Nr	Tipo Bobina Coil Type Type bobine Spulentyp (1)	Attacchi SAE Flare Connections SAE Flare Raccords SAE Flare Anschlüsse SAE Flare	Kv [m <sup>3</sup> /h]	PS [bar]	TS [°C]		Confezione n° pz Package Pcs. Emballage Verpackung
							Min	Max	
Azione diretta Direct acting Action directe Direkte Aktion		1020N/2S	HF2 HF3 HF4 HM2 HM3 HM4 CM2	1/4"	0,175	50	-40	+130	18
		1020N/3S		3/8"					
Servocomando a membrana Diaphragm pilot operated Servocommande à membrane Membrantrieb		1064N/3S	HF2 HF3 HF4 HM2 HM3 HM4 CM2	3/8"	0,80	50	-40	+120	18
		1064N/4S		1/2"					
		1070N/4S		50	-40	+120	24		
		1070N/5S						5/8"	2,61
		1090N/5S		50	-40	+120	14		
		1090N/6S						3/4"	4,8
Servocomando a pistone Piston pilot operated Servocommande à piston Kolbenantrieb		1034N/3S	HF2 HF3 HF4 HM2 HM3 HM4 CM2	3/8"	1,0	50	-40	+130	18
		1034N/4S		1/2"					
		1040N/4S		50	-40	+130	24		
		1040N/5S						5/8"	3,0
		1050N/5S		50	-40	+130	14		
		1050N/6S						3/4"	4,8

(1) bobine che possono essere montate sulle valvole

(1) coils that can be mounted on the valves

(1) bobines qui peuvent être montés sur les vannes

(1) Spulen, die an den Ventilen montiert werden können

**VALVOLE SOLENOIDI N.C. ATTACCHI SAE FLARE CON BOBINE 220/230 VAC (A6)**  
**N.C. SOLENOID VALVES SAE FLARE CONNECTIONS WITH COILS 220/230 VAC (A6)**  
**ELECTROVANNES N.F. SAE FLARE RACCORDS AVEC BOBINE 220/230 VAC (A6)**  
**N.G. MAGNETVENTILE BOERDELANSCHLUSS MIT SPULE 220/230 VAC (A6)**

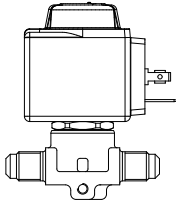
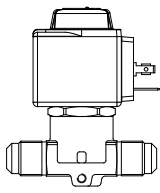
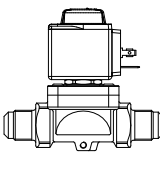
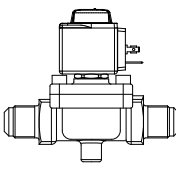
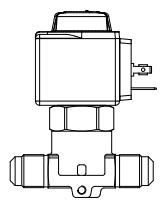
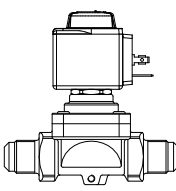
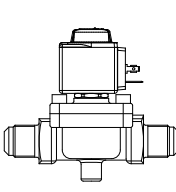
Principio di funzionamento Operating principle Principe de fonctionnement Funktionsprinzip	Disegno Drawing Dessin Zeichnung	N° Catalogo Part Number N° Catalogue Katalog Nr	Tipo Bobina Coil Type Type bobine Spulentyp (1)	Attacchi SAE Flare Connections SAE Flare Raccords SAE Flare Anschlüsse SAE Flare	Kv [m³/h]	PS [bar]	TS [°C]		Confezione n° pz Package Pcs. Emballage Verpackung
							Min	Max	
Azione diretta Direct acting Action directe Direkte Aktion		1020N/2A6	HF2	1/4"	0,175	50	-40	+130	18
		1020N/3A6		3/8"	0,23				
Servocomando a membrana Diaphragm pilot operated Servocommande à membrane Membrantrieb		1064N/3A6	HF2	3/8"	0,8	50	-40	+120	18
		1064N/4A6		1/2"					
		1070N/4A6		1/2"	2,2	50	-40	+120	24
		1070N/5A6		5/8"	2,61				
		1090N/5A6		5/8"	3,8	50	-40	+120	14
		1090N/6A6		3/4"	4,8				
Servocomando a pistone Piston pilot operated Servocommande à piston Kolbenantrieb		1034N/3A6	HF2	3/8"	1,0	50	-40	+130	18
		1034N/4A6		1/2"					
		1040N/4A6		1/2"	2,4	50	-40	+130	24
		1040N/5A6		5/8"	3,0				
		1050N/5A6		5/8"	3,8	50	-40	+130	14
		1050N/6A6		3/4"	4,8				

(1) bobine montate sulle valvole

(1) coils mounted on the valves

(1) bobines montés sur des vannes

(1) An den Ventilen montierte Spulen

**VALVOLE SOLENOIDE N.C. ATTACCHI ODS SENZA BOBINA**  
**N.C. SOLENOID VALVES ODS CONNECTIONS WITHOUT COILS**  
**VANNES ELECTROMAGNETIQUES N.F. ODS RACCORDS SANS BOBINE**  
**N.G. MAGNETVENTILE ODS ANSCHLÜSSE OHNE SPULE**

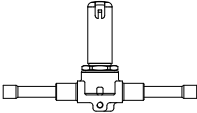
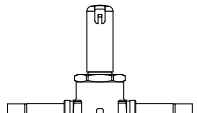
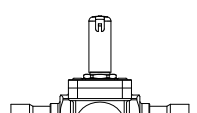
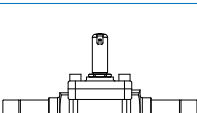
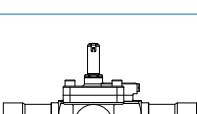
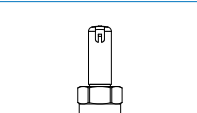
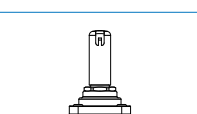
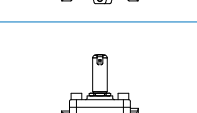
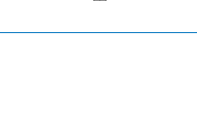
Principio di funzionamento Operating principle Principe de fonctionnement Funtionsprinzip	Disegno Drawing Dessin Zeichnung	N° Catalogo Part Number N° Catalogue Katalog Nr	Tipo Bobina Coil Type Type bobine Spulentyp (1)	Attacchi ODS Ø Connections ODS Ø Raccords ODS Ø Anschlüsse ODS Ø		Kv [m³/h]	PS [bar]	TS [°C]		Confezione n° pz Package Pcs. Emballage Verpackung		
				[in.]	[mm]			Min	Max			
Azione diretta Direct acting Action directe Direkte Aktion		1028N/2S	HF2	1/4"	-	0,15	50	-40	+130	24		
		1028N/2S.E	HF3	1/4"	-	0,23						
		1028N/3S	HF4	3/8"	-							
		1028N/M10S	HM2 HM3 HM4 CM2	-	10							
Servocomando a membrana Diaphragm pilot operated Servocommande à membrane Membrantrieb		1068N/3S	HF2 HF3 HF4 HM2 HM3 HM4 CM2	3/8"	-	0,8	50	-40	+120	24		
		1068N/M10S		-	10							
		1068N/M12S		-	12							
		1068N/4S		1/2"	-							
		1078N/M12S		-	12	2,2	50	-40	+120	17		
		1078N/4S		1/2"	-							
		1078N/5S		5/8"	16	2,61						
		1079N/7S		7/8"	22							
		1098N/5S		5/8"	16	3,8	50	-40	+120	14		
		1098N/6S		3/4"	-						4,8	
		1098N/7S		7/8"	22	5,7						
		1099N/9S		1.1/8"	-							
		1078N/9S		1.1/8"	-	10	50	-40	+120	1		
		1079N/11S		1.3/8"	35							
	Servocomando a pistone Piston pilot operated Servocommande à piston Kolbenantrieb			1038N/3S	HF2 HF3 HF4 HM2 HM3 HM4 CM2	3/8"	-	1,0	50	-40	+130	24
				1038N/M10S		-	10					
1038N/M12S			-	12								
1038N/4S			1/2"	-								
		1048N/M12S	-	12		2,4	50	-40	+130	14		
		1048N/4S	1/2"	-								
		1048N/5S	5/8"	16		3,0						
		1049N/7S	7/8"	22								
		1058N/5S	5/8"	16		3,8	50	-40	+130	14		
		1058N/6S	3/4"	-							4,8	
		1058N/7S	7/8"	22		5,7						
		1059N/9S	1.1/8"	-								
		1098N/9S	1.1/8"	-		10	50	-40	+130	1		
		1099N/11S	1.3/8"	35								
		1078NW/11S	1.3/8"	35		16						
		1079NW/13S	1.5/8"	-								
		1079NW/M42S	-	42		25						
		1078NW/13S	1.5/8"	-								
	1078NW/M42S	-	42	25								
	1079NW/17S	2.1/8"	54									

(1) bobine che possono essere montate sulle valvole | (1) coils that can be mounted on the valves

(1) bobines qui peuvent être montés sur les vannes | (1) Spulen, die an den Ventilen montiert werden können

**VALVOLE SOLENOIDE N.C. ATTACCHI ODS CON BOBINA 220/230 VAC (A6)**  
**N.C. SOLENOID VALVES ODS CONNECTIONS WITH COIL 220/230 VAC (A6)**  
**VANNES ELECTROMAGNETIQUES N.F. ODS RACCORDS AVEC BOBINE 220/230 VAC (A6)**  
**N.G. MAGNETVENTILE ODS ANSCHLÜSSE MIT SPULE 220/230 VAC (A6)**

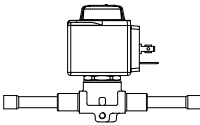
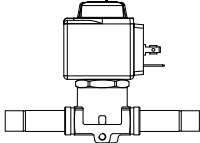
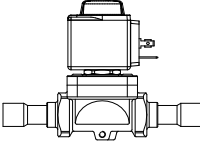
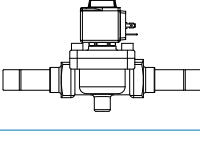
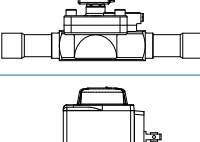
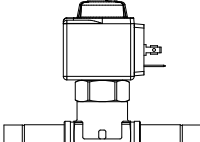
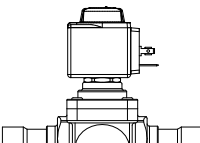
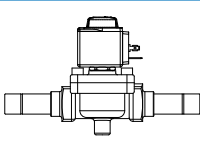
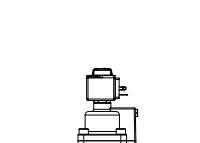
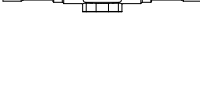
Principio di funzionamento Operating principle Principe de fonctionnement Funktionsprinzip	Disegno Drawing Dessin Zeichnung	N° Catalogo Part Number N° Catalogue Katalog Nr	Tipo Bobina Coil Type Type bobine Spulentyp (1)	Attacchi ODS Ø Connections ODS Ø Raccords ODS Ø Anschlüsse ODS Ø		Kv [m³/h]	PS [bar]	TS [°C]		Confezione n° pz Package Pcs. Emballage Verpackung
				[in.]	[mm]			Min	Max	
Azione diretta Direct acting Action directe Direkte Aktion		1028N/2A6	HF2	1/4"	-	0,15	50	-40	+130	24
		1028N/2A6.E		1/4"	-	0,23				
		1028N/3A6		3/8"	-					
		1028N/M10A6		-	10					
Servocomando a membrana Diaphragm pilot operated Servocommande à membrane Membranantrieb		1068N/3A6	HF2	3/8"	-	0,8	50	-40	+120	24
		1068N/M10A6		-	10					
		1068N/M12A6		-	12					
		1068N/4A6		1/2"	-					
		1078N/M12A6		-	12	2,2	50	-40	+120	17
		1078N/4A6		1/2"	-					
		1078N/5A6		5/8"	16					
		1079N/7A6		7/8"	22	2,61	50	-40	+120	14
		1098N/5A6		5/8"	16					
		1098N/6A6		3/4"	-					
		1098N/7A6		7/8"	22					
		1099N/9A6		1.1/8"	-	5,7	50	-40	+120	1
		1078N/9A6		1.1/8"	-					
		1079N/11A6		1.3/8"	35					
Servocomando a pistone Piston pilot operated Servocommande à piston Kolbenantrieb		1038N/3A6	HF2	3/8"	-	1,0	50	-40	+130	24
		1038N/M10A6		-	10					
		1038N/M12A6		-	12					
		1038N/4A6		1/2"	-					17
		1048N/M12A6		-	12	2,4	50	-40	+130	
		1048N/4A6		1/2"	-					
		1048N/5A6		5/8"	16					
		1049N/7A6		7/8"	22	3,0	50	-40	+130	14
		1058N/5A6		5/8"	16					
		1058N/6A6		3/4"	-					
		1058N/7A6		7/8"	22					
		1059N/9A6		1.1/8"	-	5,7	50	-40	+130	1
		1098N/9A6		1.1/8"	-					
		1099N/11A6		1.3/8"	35					
		1078NW/11A6		1.3/8"	35	10	50	-40	+130	1
		1079NW/13A6		1.5/8"	-					
		1079NW/M42A6		-	42					
1078NW/13A6		1.5/8"	-							
1078NW/M42A6		-	42							
1079NW/17A6		2.1/8"	54							

(1) bobine montate sulle valvole

(1) coils mounted on the valves

(1) bobines montés sur des vannes

(1) An den Ventilen montierte Spulen

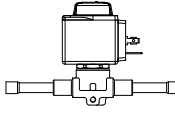
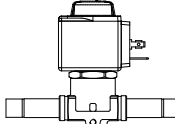
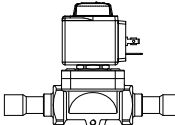
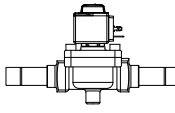
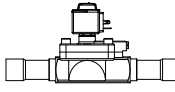
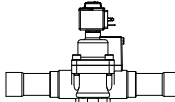

**VALVOLE SOLENOIDE N.C. ATTACCHI ODS CON BOBINA 220/230 VAC - CONFORMITÀ ATEX PER USO IN EX ZONA 2**  
**N.C. SOLENOID VALVES ODS CONNECTIONS WITH COILS 220/230 VAC - ATEX CONFORMITY FOR USE IN EX ZONE 2**  
**VANNES ELECTROMAGNETIQUES N.F. ODS RACCORDS AVEC BOBINE 220/230 VAC - CONFORMITÉ ATEX POUR UTILISATION EN ZONE EX 2**  
**N.G. MAGNETVENTILE ODS ANSCHLÜSSE MIT SPULE 220/230 VAC - ATEX-KONFORMITÄT FÜR DEN EINSATZ IN EX-ZONE 2**

Principio di funzionamento Operating principle Principe de fonctionnement Funtionsprinzip	Disegno Drawing Dessin Zeichnung	N° Catalogo Part Number N° Catalogue Katalog Nr	Tipo Bobina Coil Type Type bobine Spulentyp (1)	Attacchi ODS Ø Connections ODS Ø Raccords ODS Ø Anschlüsse ODS Ø		Kv [m³/h]	PS [bar]	TS [°C]		Confezione n° pz Package Pcs. Emballage Verpackung	
				[in.]	[mm]			Min	Max		
Azione diretta Direct acting Action directe Direkte Aktion		1028EX/2A6	HM2(EX)	1/4"	-	0,15	50	-40	+130	24	
		1028EX/2A6.E		1/4"	-	0,23					
		1028EX/3A6		3/8"	-						
		1028EX/M10A6		-	10						
Servocomando a membrana Diaphragm pilot operated Servocommande à membrane Membranantrieb		1068EX/3A6	HM2(EX)	3/8"	-	0,8	50	-40	+120	24	
		1068EX/M10A6		-	10						
		1068EX/M12A6		-	12						
		1068EX/4A6		1/2"	-						
		1078EX/M12A6		-	12	2,2				17	
		1078EX/4A6		1/2"	-						
		1078EX/5A6		5/8"	16	2,61					
		1079EX/7A6		7/8"	22	5,7					
				1098EX/7A6	7/8"						22
	1099EX/9A6			1.1/8"	-						
		1078EX/9A6		1.1/8"	-	10					14
		1079EX/11A6		1.3/8"	35	1					
	Servocomando a pistone Piston pilot operated Servocommande à piston Kolbenantrieb			1098EX/9A6	HM2(EX)						1.1/8"
1099EX/11A6			1.3/8"	35		10					

(1) bobine montate sulle valvole

(1) coils mounted on the valves

(1) bobines montés sur des vannes

(1) An den Ventilen montierte Spulen

**VALVOLE SOLENOIDE PULSATE (#)**  
**PULSE SOLENOID VALVES (#)**  
**PULSÉ ÉLECTROVANNE (#)**  
**PULSE MAGNETVENTILE (#)**

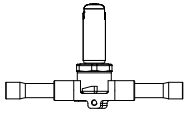
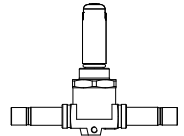
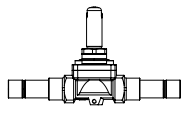
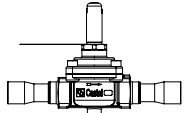
Principio di funzionamento Operating principle Principe de fonctionnement Funktionsprinzip	Disegno Drawing Dessin Zeichnung	N° Catalogo Part Number N° Catalogue Katalog Nr	Tipo Bobina Coil Type Type bobine Spulentyp (1)	Attacchi ODS Ø Connections ODS Ø Raccords ODS Ø Anschlüsse ODS Ø		Kv [m³/h]	PS [bar]	TS [°C] (2)		Confezione n° pz Package Pcs. Emballage Verpackung
				[in.]	[mm]			Min	Max	
Azione diretta Direct acting Action directe Direkte Aktion		1328N/2S020	HF2 HF3 HF4 HM2 HM3 HM4 CM2	1/4"	-	0,15	50	-40	+150	24
		1328N/2S030		1/4"	-	0,23				
		1328N/3S020		3/8"	-	0,15				
		1328N/3S030		3/8"	-	0,23				
		1328N/M10S020		-	10	0,15				
		1328N/M10S030		-	10	0,23				
Servocomando a pistone Piston pilot operated Servocommande à piston Kolbenantrieb		1338N/3S065	HF2 HF3 HF4 HM2 HM3 HM4 CM2	3/8"	-	1,0	50	-40	+150	24
		1338N/M10S065		-	10					
		1338N/M12S065		-	12					
		1338N/4S065		1/2"	-					
		1348N/M12S125		-	12	2,4	50	-40	+150	14
		1348N/4S125		1/2"	-					
		1348N/5S125		5/8"	16					
		1358N/5S165		5/8"	16	3,8	50	-40	+150	14
		1358N/6S165		3/4"	-	4,8				
		1358N/7S165		7/8"	22	5,7				

(#)  
per by-pass gas caldo, iniezione di liquido,  
linea dell'olio

(1)  
bobine che possono essere montate sulle  
valvole

(2)  
per impiego su linea dell'olio TS = -10  
/+70 °C

(#)  
for hot gas by-pass, liquid injection, oil line

(1)  
coils that can be mounted on the valves

(2)  
for use on the oil line TS = -10 /+70 °C

(#)  
pour la dérivation de gaz chaud, injection de  
liquide, conduite d'huile

(1)  
bobines qui peuvent être montés sur les  
vannes



(2)  
pour utilisation sur la conduite d'huile TS =  
-10 / +70 °C

(#)  
für Heißgas-Bypass, Flüssigkeitseinspritzung,  
Ölleitung

(1)  
Spulen, die an den Ventilen montiert werden  
können

(2)  
für den Einsatz in der Ölleitung TS = -10  
/+70 °C

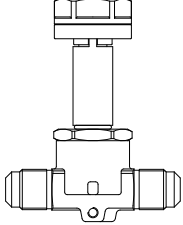
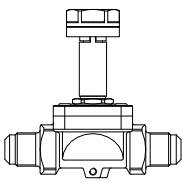
**VALVOLE SOLENOIDE N.A. ATTACCHI SAE FLARE SENZA BOBINA**  
**N.O. SOLENOID VALVES SAE FLARE CONNECTIONS WITHOUT COILS**  
**VANNES ELECTROMAGNETIQUES N.O. SAE FLARE RACCORDS SANS BOBINE**  
**N.O. MAGNETVENTILE MIT BOERDELANSCHLUSS OHNE SPULE**

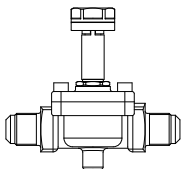
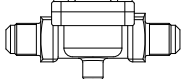
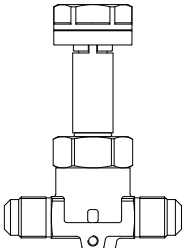
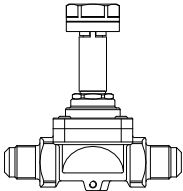
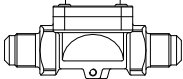
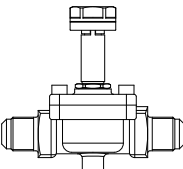
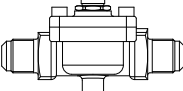
Principio di funzionamento Operating principle Principe de fonctionnement Funtionsprinzip	Disegno Drawing Dessin Zeichnung	N° Catalogo Part Number N° Catalogue Katalog Nr	Tipo Bobina Coil Type Type bobine Spulentyp (1)	Attacchi SAE Flare Connections SAE Flare Raccords SAE Flare Anschlüsse SAE Flare	Kv [m <sup>3</sup> /h]	PS [bar]	TS [°C]		Confezione n° pz Package Pcs. Emballage Verpackung
							Min	Max	
Servocomando a membrana Diaphragm pilot operated Servocommande à membrane Membrantrieb		1164N/3S	HM3	3/8"	0,8	50	-40	+120	24
		1170N/4S		1/2"	2,2	50	-40	+120	24
		1170N/5S		5/8"	2,61				
		1190N/5S		5/8"	3,8	50	-40	+120	14
		1190N/6S		3/4"	4,8				
Servocomando a pistone Piston pilot operated Servocommande à piston Kolbenantrieb		1134N/3S	HM3	3/8"	1,0	50	-40	+130	24
		1140N/4S		1/2"	2,4	50	-40	+130	24
		1140N/5S		5/8"	3,0				
		1150N/5S		5/8"	3,8	50	-40	+130	14
		1150N/6S		3/4"	4,8				

Le valvole NA sono state progettate per il funzionamento con bobine in corrente continua.

Per applicazioni con alimentazione a 220/230 V AC utilizzare la bobina 9120/RD6 con il connettore 9150/R45

(1) bobine che possono essere montate sulle valvole

The N.O. valves have been designed to work only with direct current coil.

To use them with an alternate current supply it's necessary to mate the N.O. valve with the 9120/RD6 coil and the connector 9150/R45

(1) coils that can be mounted on the valves

Les vannes N.O. ont été conçus pour le fonctionnement avec des bobines en courant continu uniquement.

Pour les applications avec alimentation en courant alternatif, il faut accoupler la vanne N.O. avec la bobine 9120/RD6 et le connecteur 9150/R45.

(1) bobines qui peuvent être montés sur les vannes

Die N.O. Ventile sind ausschließlich für den betrieb mit gleichstromspulen vorgesehen. Bei verwendung mit wechselstromspeisung ist das N.O. Ventile mit spule 9120/RD6 und verbinder 9150/R45

(1) Spulen, die an den Ventilen montiert werden können

**VALVOLE SOLENOIDE N.A. ATTACCHI ODS SENZA BOBINA**  
**N.O. SOLENOID VALVES ODS CONNECTIONS WITHOUT COILS**  
**VANNES ELECTROMAGNETIQUES N.O. ODS RACCORDS SANS BOBINE**  
**N.O. MAGNETVENTILE ODS ANSCHLÜSSE OHNE SPULE**

Principio di funzionamento Operating principle Principe de fonctionnement Funtionsprinzip	Disegno Drawing Dessin Zeichnung	N° Catalogo Part Number N° Catalogue Katalog Nr	Tipo Bobina Coil Type Type bobine Spulentyp (1)	Attacchi ODS Ø Connections ODS Ø Raccords ODS Ø Anschlüsse ODS Ø		Kv [m³/h]	PS [bar]	TS [°C]		Confezione n° pz Package Pcs. Emballage Verpackung	
				[in.]	[mm]			Min	Max		
				Servocomando a membrana Diaphragm pilot operated Servocommande à membrane Membranantrieb				1168N/3S	HM3		3/8"
1168N/M10S	-	10									
	1178N/M12S	HM3	-		12	2,2	50	-40		+120	14
	1178N/4S		1/2"		-						
	1178N/5S		5/8"		16	2,61					
	1198N/5S	HM3	5/8"		16	3,8	50	-40		+120	14
	1198N/6S		3/4"		-						
	1198N/7S		7/8"		22	5,7					
	1178N/9S	HM3	1.1/8"		-	10	50	-40		+120	1
Servocomando a pistone Piston pilot operated Servocommande à piston Kolbenantrieb		1138N/3S	HM3	3/8"	-	1,0	50	-40	+130	24	
		1138N/M10S		-	10						
		1148N/M12S		HM3	-	12	2,4	50	-40	+130	14
		1148N/4S			1/2"	-					
		1148N/5S			5/8"	16	3,0				
		1158N/5S		HM3	5/8"	16	3,8	50	-40	+130	14
		1158N/6S			3/4"	-					
		1158N/7S			7/8"	22	5,7				
		1198N/9S		HM3	1.1/8"	-	10	50	-40	+130	1
		1178NW/11S			1.3/8"	35					
		1178NW/13S			1.5/8"	-	25				
		1178NW/M42S			-	42					

Le valvole NA sono state progettate per il funzionamento con bobine in corrente continua.  
 Per applicazioni con alimentazione a 220/230 V AC utilizzare la bobina 9120/RD6 con il connettore 9150/R45

(1) bobine che possono essere montate sulle valvole

The N.O. valves have been designed to work only with direct current coil.  
 To use them with an alternate current supply it's necessary to mate the N.O. valve with the 9120/RD6 coil and the connector 9150/R45

(1) coils that can be mounted on the valves

Les vannes N.O. ont été conçus pour le fonctionnement avec des bobines en courant continu uniquement.  
 Pour les applications avec alimentation en courant alternatif, il faut accoupler la vanne N.O. avec la bobine 9120/RD6 et le connecteur 9150/R45.

(1) bobines qui peuvent être montés sur les vannes

Die N.O. Ventile sind ausschließlich für den betrieb mit gleichstromspulen vorgesehen.  
 Bei verwendung mit wechselstromspeisung ist das N.O. Ventile mit spule 9120/RD6 und verbinder 9150/R45

(1) Spulen, die an den Ventilen montiert werden können

**BOBINE  
COILS  
BOBINES  
SPULEN**

Disegno Drawing Dessin Zeichnung	Tipo Bobina Coil Type Type bobine Spulentyp	N° catalogo Part number N° Catalogue Katalog Nr	Tensione Voltage Tension Spannung [V]	Frequenza Frequency Fréquence Frequenz [Hz]	Potenza Power Puissance Leistung [W]	Note Note Notes Hinweise	Lunghezza cavo Cable length Longueur du câble Kabellänge [m]	Confezione n° pz Package Pcs. Emballage Verpackung	
	CM2 (1)	9110/RA2	24	50/60	8	-	1	8	
		9110/RA4	110						
		9110/RA6	220/230						
		9110/RA7	240						
	HM3	9120/RD1	12 D.C.	-	20	-	-	45	
		9120/RD2	24 D.C.						
		9120/RD3	27 D.C.						
		9120/RD4	48 D.C.						
		9120/RD6 (3)	220 RAC						
	HF2	9300/RA2	24	50/60	8	-	-	30	
		9300/RA4	110						
		9300/RA6	220/230						
		9300/RA7	240						
		9300/RA8	380						
	HF3	9320/RA6	220/230	50/60	12	-	-	18	
		9320/RD1	12 D.C.						
		9320/RD2	24 D.C.						
		9320/RD3	27 D.C.						
	HF4	<b>NEW</b> 9360/RA2	24	50/60	8	-	-	45	
		<b>NEW</b> 9360/RA4	110/120						
		<b>NEW</b> 9360/RA6	220/230						
		<b>NEW</b> 9360/RA7	240						
		<b>NEW</b> 9360/RD1	12 D.C.						17
		<b>NEW</b> 9360/RD2	24 D.C.						15,5
	HM2 (2)	9100EX/RA2	24	50/60	8	Omologazione ATEX per uso in EX zona 2 ATEX approval for use in EX Zone 2 Homologation ATEX pour utilisation en zone Ex 2 ATEX-Zulassung für den Einsatz in EX-Zone 2	-	90	
		9100EX/RA4	110						
		9100EX/RA6	220/230						
		9100EX/RA7	240						
	CM2 (2)	9110EX/RA2	24	50/60	8	Omologazione ATEX per uso in EX zona 2 ATEX approval for use in EX Zone 2 Homologation ATEX pour utilisation en zone Ex 2 ATEX-Zulassung für den Einsatz in EX-Zone 2	1	8	
		9110EX/RA4	110						
		9110EX/RA6	220/230						
		9110EX/RA7	240						

(1)  
bobina dotata di ricambio G9150/R97

(2)  
bobina dotata di ricambio G9151/R14

(3)  
Utilizzare esclusivamente con connettore  
raddrizzatore 9150/R45

Bobine 9160/... in esaurimento scorte

(1)  
coil with spare part G9150/R97

(2)  
coil with spare part G9151/R14

(3)  
Use only with 9150/R45 connector /  
rectifier

Coils 9160/.. running out of stock

(1)  
Bobine avec remplacement G9150/R97

(2)  
Bobine avec remplacement G9151/R14

(3)  
Utiliser exclusivement en association avec le  
connecteur/redresseur 9150/R45

Bobines 9160/... en épuisement du stock

(1)  
Spule mit Ersatz G9150/R97 ausgestattet

(2)  
Spule mit Ersatz G9151/R14 ausgestattet

(3)  
Bitte nur mit verbinder/gleichrichter 9150/  
R45 benutzen

Spulen 9160/.. bis zum Ende der Vorräte  
erhältlich

**CONNETTORI  
CONNECTORS  
CONNECTEURS  
STECKER**

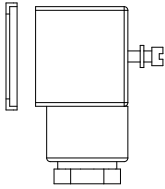
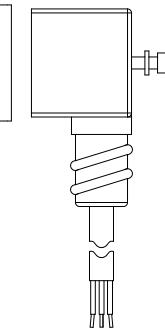
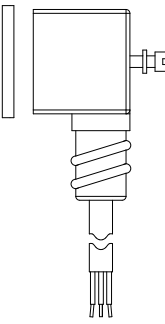
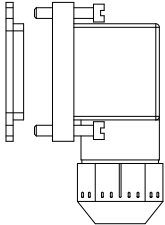
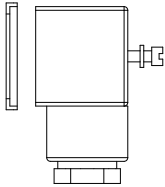
Disegno Drawing Dessin Zeichnung	N° Catalogo Part number N° Catalogue Katalog Nr	Grado di protezione Degree of protection Degrè de protection Schutz - klasse	Lunghezza cavo Cable length Longueur du câble Kabellänge [m]	Note Note Notes Hinweise	Confezione n° pz Package pcs Emballage Verpackung
	9150/R02	IP 65	-		240
	9150/R45 (1)				1
	9150/R90 (1)	IP 65	2		1
	9900/X66	IP 65	1		50
	9900/X84		1,5		50
	9900/X73		2		30
	9900/X55		3		25
	9900/X54		5		25
	9900/X93		10		15
	9901/X41		15		15
	9155/R01	IP 65 / IP 68	-		120
	9155/R02	IP 65 / IP 68	1		1
	9150EX/R02	IP 65	-	Omologazione ATEX per uso in EX zona 2 ATEX approval for use in EX Zone 2 Homologation ATEX pour utilisation en zone Ex 2 ATEX-Zulassung für den Einsatz in EX-Zone 2	240

(1)  
Connettore/Raddrizzatore: tensione  
d'alimentazione 220/230V AC

(1)  
Connector/Rectifier: supply voltage  
220/230V AC

(1)  
Connecteur/Redresseur: tension  
d'alimentation 220/230V AC

(1)  
Verbinder/Gleichrichter: Speisespannung  
220/230V AC

**SISTEMA "SMART CONNECTOR"  
"SMART CONNECTOR" SYSTEM  
SYSTÈME "SMART CONNECTOR"  
"SMART CONNECTOR" SYSTEM**



Disegno Drawing Dessin Zeichnung	N° catalogo Part number N° Catalogue Katalog Nr	Tensione Voltage Tension Spannung [V]	Frequenza Frequency Fréquence Frequenz [Hz]	T boost [msec]	Potenza Power Puissance Leistung		Confezione n° pz Package pcs. Emballage Verpackung
					esercizio working travail Arbeit [W]	avvio start début Anfang [W]	
	9910/RD1	12 D.C.	-	130	3	50	12
	9910/RD2	24 D.C.	-	130	5	50	
	9910/RA2	24	50/60	200	7	50	
	9910/RA6	220	50/60	200	7	50	
	9910/RA7	240	50/60	200	7	50	

**MAGNETE PERMANENTE  
PERMANENT MAGNET  
OUTIL MAGNETIQUE  
DAUERMAGNET**

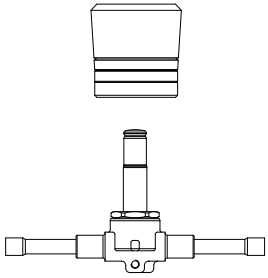
Disegno Drawing Dessin Zeichnung	N° Catalogo Part number N° Catalogue Katalog Nr	Confezione n° pz Package pcs Emballage Verpackung
	9900/X91	1

**VALVOLE DI SICUREZZA**  
**SAFETY VALVES**  
**SOUAPES DE SURETE**  
**SICHERHEITSVENTILE**

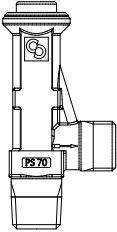
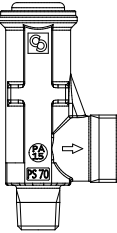
Disegno Drawing Dessin Zeichnung	N° catalogo Part number N° Catalogue Katalog Nr	Attacchi Connections Raccords Anschlüsse		Sezione orificio Orifice section Section orifice Öffnungs- querschnitt [mm <sup>2</sup> ]	Coefficiente di scarico Kd Discharge coefficient Kd Coefficient d'écoulement Kd Ausströmungsfaktor Kd	Campo taratura Set pressure range Champ de tarage Einstellbereich [bar]	PS [bar]	TS [°C]		Confezione n° pz Package pcs Emballage Verpackung
		IN	OUT					min	max	
	3061/2C	1/4" NPT	3/8" G	44,2	0,89	11 → 60	70	-50	+150	18
	3061/3C	3/8" NPT	1/2" G							
	3061/4C	1/2" NPT	1/2" G							
	3065/4C	1/2" NPT	1" G	132,7	0,87	11 → 60	70	-50	+150	24
	3065/6C	3/4" NPT	1" G							

**VALVOLE DI SICUREZZA OMOLOGATE SECONDO NORMA CINESE TSG ZF001-2006**  
**SAFETY VALVES APPROVED ACCORDING TO CHINESE STANDARD TSG ZF001-2006**  
**SOUAPES DE SURETE APPROUVÉ SELON LA NORME CHINOISE TSG ZF001-2006**  
**SICHERHEITSVENTILE ZUGELASSEN NACH CHINESISCHEM STANDARD TSG ZF001-2006**

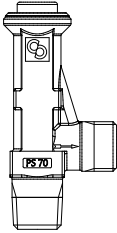
Disegno Drawing Dessin Zeichnung	N° Catalogo Part Number N° Catalogue Katalog Nr	Attacchi Connections Raccords Anschlüsse		Sezione orificio Orifice section Section orifice Öffnungs- querschnitt [mm <sup>2</sup> ]	Coefficiente di scarico corretto Kdr De-rated discharge coefficient Kdr Coefficient de décharge déclassé Kdr Abgeminderter Abflusskoeffizient Kdr	Campo taratura Set pressure range Champ de tarage Einstellbereich [bar]	PS [bar]	TS [°C]		Confezione n° pz Package pcs Emballage Verpackung
		IN	OUT					Min	Max	
	3061/2TS	1/4" NPT	3/8" G	44,2	0,783-G	11 → 60	70	-50	+120	18
	3061/3TS	3/8" NPT	1/2" G							
	3061/4TS	1/2" NPT	1/2" G							

Numero di licenza CASTEL per la produzione di valvole di sicurezza: TSF700F77-2022

CASTEL license number to manufacture safety valves: TSF700F77-2022

Numéro de licence CASTEL pour la fabrication de soupapes de sécurité: TSF700F77-2022

CASTEL-Lizenznummer zur Herstellung von Sicherheitsventilen: TSF700F77-2022

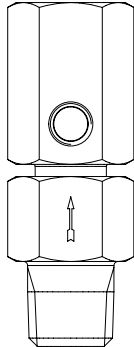

**DISPOSITIVI DI SICUREZZA CON DISCO DI ROTTURA**  
**BURSTING DISCSAFETY DEVICES**  
**DISPOSITIF DE SÉCURITÉ AVEC DISQUE DE RUPTURE**  
**SICHERHEITSVORRICHTUNG MIT BERSTPLATTE**

Disegno Drawing Dessin Zeichnung	N° catalogo Part number N° Catalogue Katalog Nr	Attacchi Connections Raccords Anschlüsse			Sezione orificio Orifice section Section orifice Öffnungs- querschnitt [mm <sup>2</sup> ]	Pressione di rottura Pb Bursting pressure Pb Pression de rupture Pb Brechdruck Pb [bar]	Max pressione d'esercizio Max operating pressure Pression d'exercice max. Max. Betriebsdruck	PS [bar]	TS [°C]		Confezione n° pz Package pcs Emballage Verpackung
		IN maschio male IN IN mâle EINGANG mit Außengewinde	OUT femmina female OUT OUT femelle AUSGANG mit Innengewinde	servizio service service Hilfsanschluss					min	max	
	3070/44C140	1/2" NPT	1/2" NPT	2 x 1/8" NPT	113	14,0	75 % Pb	55	-50	+150	20
	3070/44C150					15,0					
	3070/44C160					16,0					
	3070/44C190					19,0					
	3070/44C210					21,0					
	3070/44C230					23,0					
	3070/44C240					24,0					
	3070/44C248					24,8					
	3070/44C250					25,0					
	3070/44C270					27,0					
	3070/44C275					27,5					
	3070/44C280					28,0					
	3070/44C370					37,0					
	3070/44C440					44,0					
	3070/44C470					47,0					
	3070/44C500					50,0					
3070/44C520	52,0										

**RUBINETTI DI SCAMBIO**  
**CHANGEOVER VALVES**  
**VANNE D'ECHANGE**  
**WECHSELHAHN**

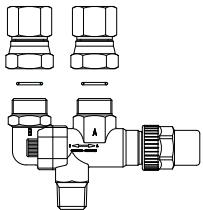
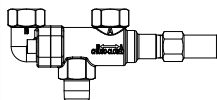
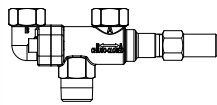
Disegno Drawing Dessin Zeichnung	N° Catalogo Part number N° Catalogue Katalog Nr	Raccordi forniti Supplied connections raccords fournis mitgelieferte Anschlüsse	Attacchi Connections Raccords Anschlüsse		Kv [m <sup>3</sup> /h]	PS [bar]	TS [°C]		Confezione n° pz Package pcs Emballage Verpackung
			IN	OUT			Min	Max	
	3032N/32	3039/2	3/8" NPT	1/4" NPT	2,5	80	-40	+150	14
	3032N/33	3039/3	3/8" NPT	3/8" NPT	2,5				
	3032N/44	3039/4	1/2" NPT	1/2" NPT	3,3				
	3032N/64	-	3/4" NPT	1/2" NPT	9	80	-40	+150	15
	3032N/66	-	3/4" NPT	3/4" NPT	9				
	3032N/88	-	1" NPT	1" NPT	14,5	80	-40	+150	1
	3032N/108	-	1.1/4" NPT	1" NPT	20				

**COPPIE DI ATTACCHI PER RUBINETTI DI SCAMBIO**  
**COUPLE OF CONNECTIONS FOR CHANGEVER VALVES**  
**COUPLE DE CONNECTIONS POUR VANNE D'ECHANGE**  
**LÖTFITTING-PAR FÜR WECHSELHAHN**

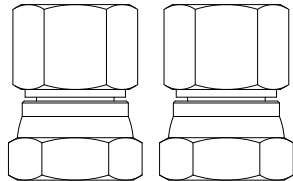
Disegno Drawing Dessin Zeichnung	N° catalogo Part number N° Catalogue Katalog Nr	Attacco Connection Raccord AnschlÜs	Materiali Materials Matériaux Werkstoffe	Confezione n° pz Package pcs. Emballage Verpackung
	3039/2	1/4" NPT-F	Ferro zincato Zinc plated steel Acier galvanisé Stahl verzinkt	25
	3039/3	3/8" NPT-F		
	3039/4	1/2" NPT-F		
	3039/30T	3/8" NPT-F	acciaio inox/ottone stainless steel/brass inox / laiton	
	3039/40T	1/2" NPT-F	Edelstahl / Messing	

**RUBINETTI DI INTERCETTAZIONE A SFERA**  
**BALL SHUT OFF VALVES**  
**VANNE D'INTERCEPTION A BOISSEAU SPHERIQUE**  
**KUGELABSPERRHAHN**

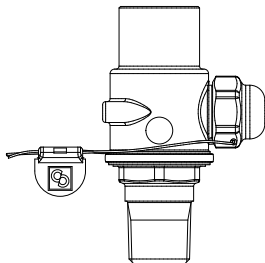
Disegno Drawing Dessin Zeichnung	N° Catalogo Part number N° Catalogue Katalog Nr	Attacchi Connections Raccords Anschlüsse NPT	Kv [m³/h]	PS [bar]	TS [°C]		Confezione n° pz Package pcs Emballage Verpackung
					Min	Max	
	3064N/22	1/4"	2,5	80	-40	+150	20
	3064N/33	3/8"	5				20
	3064N/44	1/2"	10				24
	3064N/88	1"	20				14

**RACCORDI**  
**UNIONS**  
**RACCORDS**  
**ANSCHLÜSSE**

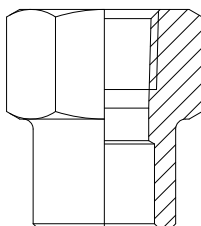
Disegno Drawing Dessin Zeichnung	N° Catalogo Part number N° Catalogue Katalog Nr	Attacchi Connections Raccords Anschlüsse		PS [bar]	Confezione n° pz Package pcs Emballage Verpackung
		NPT	ODS Ø [mm]		
	3035/2	1/4"	12	150	100
	3035/3	3/8"	18		100
	3035/4	1/2"	22		60
	3035/6	3/4"	28		24
	3035/8	1"	35	120	20
	3035/10	1.1/4"	42		4

**VALVOLE DI RITEGNO ERMETICHE - OMOLOGATE DA UNDERWRITERS LABORATORIES INC.**  
**HERMETIC CHECK VALVES - APPROVED BY UNDERWRITERS LABORATORIES INC.**  
**CLAPETS ANTI-RETOUR HERMÉTIQUES - HOMOLOGUÉS PAR UNDERWRITERS LABORATORIES INC.**  
**HERMETISCHE RÜCKSCHLAGVENTILE - ZUGELASSEN VON UNDERWRITERS LABORATORIES INC.**

Disegno Dessin Zeichnung	N° Catalogo Part number N° Catalogue Katalog nr	Attacchi Connections Raccords Anschlüsse		Kv [m³/h]	Pressione differenziale Differential pressure Pression différentielle Differenzial Druck (1) [bar]	PS [bar]	TS [°C]		Confezione n° pz Package pcs Emballage Verpackung	
		SAE Flare	ODS				Min	Max		
			Ø [in.]							Ø [mm]

**In linea con attacchi SAE FLARE / Straight with SAE FLARE connections / Connexions droites SAE flare / Durchfluss Verbindung SAE Bördel**

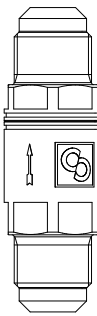
	3112W/2	1/4"			0,5	0,04	50 (2)	-40	+150	20
	3112W/3	3/8"			1,5					
	3112W/4	1/2"			1,8					
	3112W/5	5/8"			3,3					
	3112W/6	3/4"			5	0,3	50 (2)	-40	+150	16
	3113W/2	1/4"	-	-	0,5					
	3113W/3	3/8"			1,5					
	3113W/4	1/2"			1,8					
	3113W/5	5/8"			3,3					
	3113W/6	3/4"			5					

**In linea con attacchi ODS di rame / Straight with copper ODS connections / Connexions droites ODS cuivre / Durchfluss Verbindung ODS Kupfer**

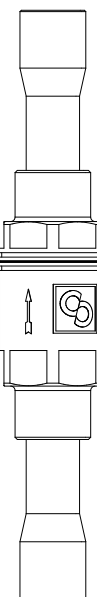
	3132W/2	1/4"	-	0,5	0,04	50 (2)	-40	+150	25
	3132W/3	3/8"	-	1,5					
	3132W/M10	-	10	1,5					
	3132W/M12	-	12	1,8					
	3132W/4	1/2"	-	1,8					
	3132W/5	5/8"	16	3,3					
	3132W/M18	-	18	5					
	3132W/6	3/4"	-	5					
	3132W/7	7/8"	22	5	0,3	50 (2)	-40	+150	21
	3133W/2	1/4"	-	0,5					
	3133W/3	3/8"	-	1,5					
	3133W/M10	-	10	1,5					
	3133W/M12	-	12	1,8					
	3133W/4	1/2"	-	1,8					
	3133W/5	5/8"	16	3,3					
	3133W/M18	-	18	5					
	3133W/6	3/4"	-	5					
	3133W/7	7/8"	22	5					

(1)  
Minima pressione a cui la valvola è completamente aperta

(2)  
MWP = 600 psi in conformità a omologazione UL

(1)  
Minimum pressure at which the valve is completely open

(2)  
MWP = 600 psi according to UL approval

(1)  
Pression minimale à laquelle la vanne est entièrement ouverte

(2)  
MWP = 600 psi conformément à homologation UL

(1)  
Mindestdruck, bei dem das Ventil vollständig offen ist

(2)  
MWP = 600 psi in Übereinstimmung zur UL-Zulassung

**VALVOLE DI RITEGNO ERMETICHE - OMOLOGATE DA UNDERWRITERS LABORATORIES INC.**  
**HERMETIC CHECK VALVES - APPROVED BY UNDERWRITERS LABORATORIES INC.**  
**CLAPETS ANTI-RETOUR HERMÉTIQUES - HOMOLOGUÉS PAR UNDERWRITERS LABORATORIES INC.**  
**HERMETISCHE RÜCKSCHLAGVENTILE - ZUGELASSEN VON UNDERWRITERS LABORATORIES INC.**

Disegno Drawing Dessin Zeichnung	N° Catalogo Part number N° Catalogue Katalog nr	Attacchi Connections Raccords Anschlüsse		Kv [m <sup>3</sup> /h]	Pressione differenziale Differential pressure Pression différentielle Differenzial Druck (1) [bar]	PS [bar]	TS [°C]		Confezione n° pz Package pcs Emballage Verpackung
		ODS					Min	Max	
		Ø [in.]	Ø [mm]						

In linea con attacchi ODS di rame / Straight with copper ODS connections / Connexions droites ODS cuivre / Durchfluss Verbindung ODS Kupfer

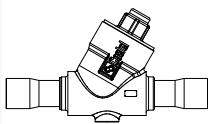
	3144W/7	7/8"	22	8,1	0,04	50 (2)	-40	+150	15
	3144W/M28	-	28	10,4					8
	3144W/9	1.1/8"	-						5
	3144NW/11	1.3/8"	35	15,6					1
	3144NW/13	1.5/8"	-	27					
	3144NW/M42	-	42						
	3144NW/17	2.1/8"	54	39					
	3145W/7	7/8"	22	8,1	0,3	50 (2)	-40	+150	15
	3145W/M28	-	28	10,4					8
	3145W/9	1.1/8"	-						5
	3145NW/11	1.3/8"	35	15,6					1
	3145NW/13	1.5/8"	-	27					
	3145NW/M42	-	42						
	3145NW/17	2.1/8"	54	39					

A squadra con attacchi ODS di rame / Right angle with copper ODS connections / Angle droit avec connexion cuivre ODS / Winkelanschluss mit Lötanschluss in Kupferausführung

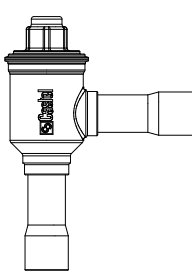
	3184W/7	7/8"	22	9	0,04	50 (3)	-40	+150	14			
	3184W/M28	-	28	19					1			
	3184W/9	1.1/8"	-									
	3185W/7	7/8"	22	9	0,3				50 (3)	-40	+150	14
	3185W/M28	-	28	19								1
	3185W/9	1.1/8"	-									

(1)  
Minima pressione a cui la valvola è completamente aperta

(2)  
MWP = 600 psi in conformità a omologazione UL

(3)  
MWP = 650 psi in conformità a omologazione UL

(1)  
Minimum pressure at which the valve is completely open

(2)  
MWP = 600 psi according to UL approval

(3)  
MWP = 650 psi according to UL approval

(1)  
Pression minimale à laquelle la vanne est entièrement ouverte

(2)  
MWP = 600 psi conformément à homologation UL

(3)  
MWP = 650 psi conformément à homologation UL

(1)  
Mindestdruck, bei dem das Ventil vollständig offen ist

(2)  
MWP = 600 psi in Übereinstimmung zur UL-Zulassung

(3)  
MWP = 650 psi in Übereinstimmung zur UL-Zulassung

**VALVOLE DI RITEGNO  
CHECK VALVES  
CLAPETS ANTI-RETOUR  
RÜCKSCHLAGVENTILE**

Disegno Drawing Dessin Zeichnung	N° Catalogo Part number N° Catalogue Katalog nr	Attacchi Connections Raccords Anschlüsse				Kv [m³/h]	Pressione differenziale Differential pressure Pression différentielle Differenzial Druck (1) [bar]	PS [bar]	TS [°C]		Confezione n° pz Package pcs Emballage Verpackung
		ODS		ODM					Min	Max	
		Ø [in.]	Ø [mm]	Ø [in.]	Ø [mm]						

In linea con attacchi ODS d'ottone / Straight with brass ODS connections / Connexions droites ODS laiton / Durchfluss Verbindung ODS Messing

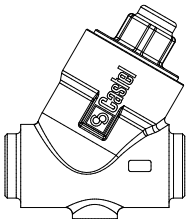
	3124N/M22	-	22	-	28	8,1	0,04	50	-40	+150	14
	3124N/7	7/8"	-	1.1/8"	-						
	3124N/M28	-	28	1.3/8"	35	10,4					
	3124N/9	1.1/8"	-	1.3/8"	35						
	3124N/11	1.3/8"	35	1.5/8"	-	15,6					
	3124N/13	1.5/8"	-	2"	-	27					1
	3124N/M42	-	42	2"	-						
	3124N/17	2.1/8"	54	-	-	39					
	3125N/M22	-	22	-	28	8,1					
	3125N/7	7/8"	-	1.1/8"	-		14				
	3125N/M28	-	28	1.3/8"	35	10,4					
	3125N/9	1.1/8"	-	1.3/8"	35						
	3125N/11	1.3/8"	35	1.5/8"	-	15,6					
	3125N/13	1.5/8"	-	2"	-	27	1				
	3125N/M42	-	42	2"	-						
	3125N/17	2.1/8"	54	-	-	39					

(1) Minima pressione a cui la valvola è completamente aperta

(1) Minimum pressure at which the valve is completely open

(1) Pression minimale à laquelle la vanne est entièrement ouverte

(1) Mindestdruck, bei dem das Ventil vollständig offen ist

**REGOLATORI DI CAPACITA'  
HOT GAS BYPASS CAPACITY REGULATORS  
RÉGULATEURS DE CAPACITÉ  
LEISTUNGSREGLER**

Disegno Drawing Dessin Zeichnung	N° catalogo Part number N° Catalogue Katalog Nr.	Attacchi Connections Raccords Anschlüsse			Campo di regolazione Regulation range Plage de régulation Regelbereich [bar]	Kv [m³/h]	PS [bar]	TS [°C]		Confezione n° pz Package pcs Emballage Verpackung
		SAE Flare	ODS [in.]	ODS [mm]				Min	Max	
	NEW 3315N/M12S	-	-	12	2 - 7	0,70	45	-40	+130	15
	NEW 3315N/4S	-	1/2"	-						
	NEW 3315N/5S	-	5/8"	16						
	NEW 3315N/7S	-	7/8"	22		1,84				8

**REGOLATORI DELLA PRESSIONE D'EVAPORAZIONE**  
**EVAPORATING PRESSURE REGULATORS**  
**RÉGULATEURS DE PRESSION D'ÉVAPORATION**  
**VERDAMPFUNGSDRUCKREGLER**

Disegno Drawing Dessin Zeichnung	N° catalogo Part number N° Catalogue Katalog Nr.	Attacchi Connections Raccords Anschlüsse			Campo di regolazione Regulation range Plage de régulation Regelbereich [bar]	Kv [m³/h]	PS [bar]	TS [°C]		Confezione n° pz Package pcs Emballage Verpackung	
		SAE Flare	ODS [in.]	ODS [mm]				Min	Max		
	NEW	3335N/M12S	-	-	12	3 - 20	2,7	45	- 40	+ 130	15
	NEW	3335N/4S	-	1/2"	-						
	NEW	3335N/5S	-	5/8"	16						
	NEW	3335N/7S	-	7/8"	22						8

**REGOLATORI DELLA PRESSIONE DI CONDENSAZIONE**  
**CONDENSING PRESSURE REGULATORS**  
**RÉGULATEURS DE PRESSION DE CONDENSATION**  
**VERFLÜSSIGUNGSDRUCKREGLER**

Disegno Drawing Dessin Zeichnung	N° catalogo Part number N° Catalogue Katalog Nr.	Attacchi Connections Raccords Anschlüsse			Campo di regolazione Regulation range Plage de régulation Regelbereich [bar]	Kv [m³/h]	P [bar]	TS [°C]		Confezione n° pz Package pcs Emballage Verpackung	
		SAE Flare	ODS [in.]	ODS [mm]				Min	Max		
	NEW	3345N/M12S	-	-	12	12-35	2,7	45	- 40	+ 130	15
	NEW	3345N/4S	-	1/2"	-						
	NEW	3345N/5S	-	5/8"	16						
	NEW	3345N/7S	-	7/8"	22						8

**VALVOLE DIFFERENZIALE**  
**DIFFERENTIAL VALVES**  
**VANNES À PRESSION DIFFÉRENTIELLE**  
**DIFFERENZDRUCKVENTILE**

Disegno Drawing Dessin Zeichnung	N° catalogo Part number N° Catalogue Katalog Nr.	Attacchi Connections Raccords Anschlüsse			Pressione differenziale d'apertura Opening differential pressure Pression différentielle d'ouverture Öffnungsdifferenzdruck [bar]	Kv [m³/h]	PS [bar]	TS [°C]		Confezione n° pz Package pcs Emballage Verpackung
		SAE Flare	ODS [in.]	ODS [mm]				Min	Max	
	3136W/M12	-	-	12	1,4 - 3	1,5	45	- 40	+ 130	16
	3136W/4	-	1/2"	-						

**INDICATORI DI LIQUIDO - OMOLOGATI DA UNDERWRITERS LABORATORIES INC.**  
**LIQUID INDICATORS - APPROVED BY UNDERWRITERS LABORATORIES INC.**  
**VOYANTS DE LIQUIDE - HOMOLOGUÉS PAR UNDERWRITERS LABORATORIES INC.**  
**FLUSSIGKEITSSCHAUGLAS - ZUGELASSEN VON UNDERWRITERS LABORATORIES INC.**

Disegno Drawing Dessin Zeichnung	N° catalogo Part number N° Catalogue Katalog Nr	Attacchi Connections Raccords Anschlüsse			PS [bar]	TS [°C]		Confezione n° pz Package pcs Emballage Verpackung
		SAE Flare	Ø ODS [in.]	Ø ODS [mm]		Min	Max	

**Attacchi SAE FLARE maschio - maschio / SAE FLARE male - male connections / Raccords SAE FLARE mâle - mâle / Bördelanschlüsse Aussen - Aussen**

	3810/22	1/4"						20
	3810/33	3/8"						
	3810/44	1/2"	-	-	50 (1)	-40	+120	
	3810/55	5/8"						
	3810/66	3/4"						

**Attacchi SAE FLARE maschio - femmina / SAE FLARE male - female connections / Raccords SAE FLARE mâle - femelle / Bördelanschlüsse Innen - Aussen**

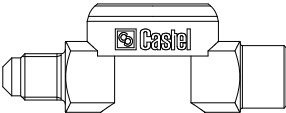
	3850/22	1/4"						20
	3850/33	3/8"						
	3850/44	1/2"	-	-	50 (1)	-40	+120	
	3850/55	5/8"						
	3850/66	3/4"						16

**Attacchi di rame a saldare / Copper braze connections / Raccords a souder en cuivre / Kupfer Lötanschlüsse**

	3840/2		1/4"	-				25	
	3840/3		3/8"	-					
	3840/M10		-	10					
	3840/M12		-	12					
	3840/4		1/2"	-				16	
	3840/5		5/8"	16					
	3840/M18		-	18					
	3840/6		3/4"	-					
	3840/7		7/8"	22					21
	3840/9		1.1/8"	-					16

(1) MWP = 500 psi in conformità a omologazione UL

(1) MWP = 500 psi according to UL approval

(1) MWP = 500 psi conformément à homologation UL

(1) MWP = 500 psi in Übereinstimmung zur UL-Zulassung

**INDICATORI DI UMIDITÀ - OMOLOGATI DA UNDERWRITERS LABORATORIES INC.**  
**MOISTURE INDICATORS - APPROVED BY UNDERWRITERS LABORATORIES INC.**  
**VOYANT LIQUIDE AVEC INDICATEURS D' HUMIDITE - HOMOLOGUÉS PAR UNDERWRITERS LABORATORIES INC.**  
**FLÜSSIGKEITSINDIKATOREN - ZUGELASSEN VON UNDERWRITERS LABORATORIES INC.**

Disegno Drawing Dessin Zeichnung	N° catalogo Part number N° Catalogue Katalog Nr	Attacchi Connections Raccords Anschlüsse			PS [bar]	TS [°C]		Confezione n° pz Package pcs Emballage Verpackung
		SAE Flare	Ø ODS [in.]	Ø ODS [mm]		Min	Max	

**Attacchi SAE FLARE maschio - maschio / SAE FLARE male - male connections / Raccords SAE FLARE mâle - mâle / Bördelanschlüsse Aussen - Aussen**

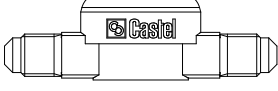
	3910/22	1/4"						
	3910/33	3/8"						
	3910/44	1/2"	-	-	50 (1)	-40	+120	20
	3910/55	5/8"						
	3910/66	3/4"						

**Attacchi SAE FLARE maschio - femmina / SAE FLARE male - female connections / Raccords SAE FLARE mâle - femelle / Bördelanschlüsse Innen - Aussen**

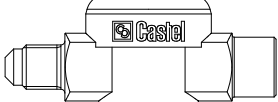
	3950/22	1/4"						
	3950/33	3/8"						
	3950/44	1/2"	-	-	50 (1)	-40	+120	20
	3950/55	5/8"						
	3950/66	3/4"						16

**Attacchi di rame a saldare / Copper braze connections / Raccords a souder en cuivre / Kupfer Lötanschlüsse**

	3940/2		1/4"	-				
	3940/3		3/8"	-				
	3940/M10		-	10				25
	3940/M12		-	12				
	3940/4		1/2"	-	50 (1)	-40	+120	
	3940/5		5/8"	16				
	3940/M18		-	18				16
	3940/6		3/4"	-				
	3940/7		7/8"	22				21
	3940/9		1.1/8"	-				16

(1)  
MWP = 500 psi in conformità a omologazione UL

(1)  
MWP = 500 psi according to UL approval

(1)  
MWP = 500 psi conformément à homologation UL

(1)  
MWP = 500 psi in Übereinstimmung zur UL-Zulassung



**INDICATORI DI LIQUIDO E INDICATORI D'UMIDITÀ**  
**LIQUID AND MOISTURE INDICATORS**  
**VOYANT LIQUIDE ET INDICATEURS D'HUMIDITE**  
**FLUSSIGKEITSSCHAUGLAS UND FLÜSSIGKEITSINDIKATOREN**

Disegno Drawing Dessin Zeichnung	N° catalogo Part number N° Catalogue Katalog Nr	Per tubo For pipe Pour tuyau Für rohr		PS [bar]	TS [°C]		Confezione n° pz Package pcs Emballage Verpackung
		Ø [in.]	Ø [mm]		Min	Max	

**A sella con indicatore di livello / Saddletype with level indicator / Type selle avec indicateur de niveau / Satteltyp mit fullstandsanzeige**

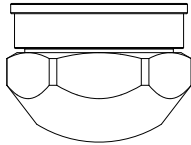
	3680/7	7/8"	22	50	-40	+120	225
	3680/9	1.1/8"	28				
	3680/11	1.3/8"	35				

**A sella / Saddle type / Embase à braser / Sattel Typ**

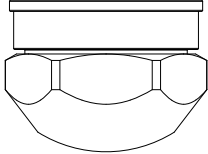
	3780N/5	5/8"	16	50	-40	+120	225
	3780N/M18	-	18				
	3780N/7	7/8"	22				
	3780N/9	1.1/8"	28				
	3780N/11	1.3/8"	35				

**FILTRI DISIDRATORI A CARTUCCIA SOLIDA 100% SETACCIO MOLECOLARE - ATTACCHI SAE FLARE - OMOLOGATI DA UNDERWRITERS LABORATORIES INC.**

**SOLID CORE FILTER DRIERS 100% MOLECULAR SIEVES - SAE FLARE CONNECTIONS - APPROVED BY UNDERWRITERS LABORATORIES INC.**  
**FILTRES DÉSHYDRATEURS AVEC CARTOUCHE SOLIDE 100% TAMIS MOLECULAIRE - RACCORDS SAE FLARE - HOMOLOGUÉS PAR UNDERWRITERS LABORATORIES INC.**

**FILTERTROCKNER MIT 100% MOLEKULARSIEB - BÖRDELANSCHLÜSSE - ZUGELASSEN VON UNDERWRITERS LABORATORIES INC.**

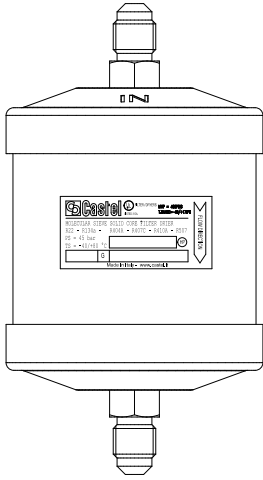
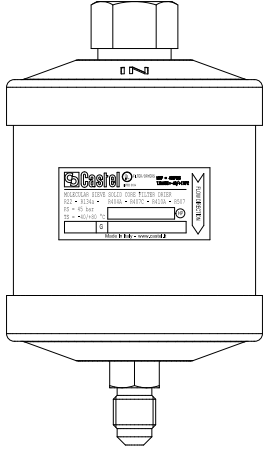
Disegno Drawing Dessin Zeichnung	N° Catalogo Part number N° Catalogue Katalog Nr	Codice internazionale International code Code international Internationaler code	Attacchi Connections Raccords Anschlüsse SAE Flare	Cubatura nominale Nominal volume Cubature nominale Nominaler rauminhalt [cm³]	PS [bar]	TS [°C]		Confezione n° pz Package pcs Emballage Verpackung
						Min	Max	
	DF303/2	032	1/4"	50	50 (1)	-40	+80	25
	DF303/3	033	3/8"					
	DF305/2	052	1/4"	80				25
	DF305/3	053	3/8"					
	DF308/2	082	1/4"	130				25
	DF308/3	083	3/8"					
	DF308/4	084	1/2"					
	DF316/2	162	1/4"	250				15
	DF316/3	163	3/8"					
	DF316/4	164	1/2"					
	DF316/5	165	5/8"					
	DF330/3	303	3/8"	500				10
	DF330/4	304	1/2"					
	DF330/5	305	5/8"					
	DF330/6	306	3/4"					
	DF341/4	414	1/2"	670				6
	DF341/5	415	5/8"					
DF341/6	416	3/4"						
	DF303/2F	-	1/4"	50	50 (1)	-40	+80	25
	DF305/2F	-	1/4"	80				25
	DF308/2F	-	1/4"	130				25
	DF308/3F	-	3/8"					
	DF316/3F	-	3/8"	250				15

(1) MWP = 680 psi in conformità a omologazione UL

(1) MWP = 680 psi according to UL approval

(1) MWP = 680 psi conformément à homologation UL

(1) MWP = 680 psi in Übereinstimmung zur UL-Zulassung

**FILTRI DISIDRATORI A CARTUCCIA SOLIDA 100% SETACCIO MOLECOLARE - ATTACCHI A SALDARE - OMOLOGATI DA UNDERWRITERS LABORATORIES INC.**

**SOLID CORE FILTER DRIERS 100% MOLECULAR SIEVES - SOLDER CONNECTIONS - APPROVED BY UNDERWRITERS LABORATORIES INC.**  
**FILTRES DÉSHYDRATEURS AVEC CARTOUCHE SOLIDE 100% TAMIS MOLECULAIRE - RACCORDE A SOUDER - HOMOLOGUÉS PAR UNDERWRITERS LABORATORIES INC.**

**FILTERTROCKNER MIT 100% MOLEKULARSIEB - LÖTANSCHLÜSSE - ZUGELASSEN VON UNDERWRITERS LABORATORIES INC.**

POLYHEDRA

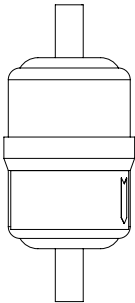
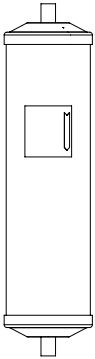
Disegno Drawing Dessin Zeichnung	N° catalogo Part number N° Catalogue Katalog Nr	Codice internazionale International code Code international Internationaler code	Attacchi Connections Raccords Anschlüsse		Cubatura nominale Nominal volume Cubature nominale Nominaler rauminhalt	PS [bar]	TS [°C]		Confezione n° pz Package pcs Emballage Verpackung
			ODS				Min	Max	
			Ø [in.]	Ø [mm]	[cm³]				
	DF303/2S	032S	1/4"	-	50	50 (1)	-40	+80	25
	DF303/3S	033S	3/8"	-					
	DF305/2S	052S	1/4"	-	80				25
	DF305/3S	053S	3/8"	-					
	DF305/M10S	-	-	10	130				25
	DF308/2S	082S	1/4"	-					
	DF308/3S	083S	3/8"	-					
	DF308/M10S	-	-	10					
	DF308/M12S	-	-	12	250				15
	DF308/4S	084S	1/2"	-					
	DF316/3S	163S	3/8"	-					
	DF316/M10S	-	-	10					
	DF316/M12S	-	-	12	500				10
	DF316/4S	164S	1/2"	-					
	DF316/5S	165S	5/8"	16					
	DF316/7S	167S	7/8"	-					
	DF330/3S	303S	3/8"	-	500				10
	DF330/4S	304S	1/2"	-					
	DF330/5S	305S	5/8"	16					
	DF330/6S	306S	3/4"	-					
DF330/7S	307S	7/8"	-	670	6				
DF341/4S	414S	1/2"	-						
DF341/5S	415S	5/8"	16						
DF341/6S	416S	3/4"	-	670	6				
DF341/7S	417S	7/8"	-						
	<b>NEW</b> 4375N/4S (2)	754S	1/2"	-	1340	50			1
	<b>NEW</b> 4375N/5S (2)	755S	5/8"	16					
	<b>NEW</b> 4375N/6S (2)	756S	3/4"	-					
	<b>NEW</b> 4375N/7S (2)	757S	7/8"	-					
	<b>NEW</b> 4375N/9S (2)	759S	1.1/8"	-					

(1): MWP = 680 psi in conformità a omologazione UL

(2): non omologato UL

(1): MWP = 680 psi according to UL approval

(2): not UL approved

(1): MWP = 680 psi conformément à homologation UL

(2): Pas approuvé UL

(1): MWP = 680 psi in Übereinstimmung zur UL-Zulassung

(2): Ohne UL-Zertifizierung

FILTRI DISIDRATORI A CARTUCCIA SOLIDA 80% SETACCIO MOLECOLARE, 20% ALLUMINA - ATTACCHI SAE FLARE - OMOLOGATI DA UNDERWRITERS LABORATORIES INC.

DEHYDRATOR FILTERS WITH SOLID CORE 80% MOLECULAR SIEVE, 20% ALUMINA - SAE FLARE CONNECTIONS - APPROVED BY UNDERWRITERS LABORATORIES INC.

FILTRES DÉSHYDRATEURS AVEC CARTOUCHE SOLIDE 80% TAMIS MOLECULAIRE, 20% ALUMINE - RACCORDS SAE FLARE - HOMOLOGUÉS PAR UNDERWRITERS LABORATORIES INC.

FILTERTROCKNER MIT 80% MOLEKULARSIEB, 20% ALUMINIUMOXID - BÖRDELANSCHLÜSSE - ZUGELASSEN VON UNDERWRITERS LABORATORIES INC.

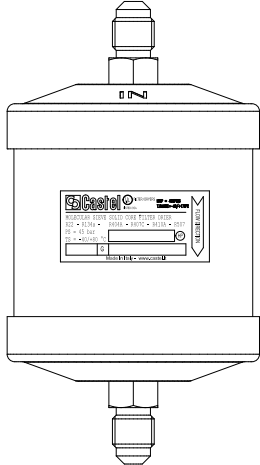
Disegno Drawing Dessin Zeichnung	N° Catalogo Part number N° Catalogue Katalog Nr	Codice internazionale International code Code international Internationaler code	Attacchi Connections Raccords Anschlüsse SAE Flare	Cubatura nominale Nominal volume Cubature nominale Nominaler rauminhalt [cm <sup>3</sup> ]	PS [bar]	TS [°C]		Confezione n° pz Package pcs Emballage Verpackung
						Min	Max	
	DF203/2	032	1/4"	50	50 (1)	-40	+80	25
	DF203/3	033	3/8"					
	DF205/2	052	1/4"	80				25
	DF205/3	053	3/8"					
	DF208/2	082	1/4"	130				25
	DF208/3	083	3/8"					
	DF208/4	084	1/2"					
	DF216/2	162	1/4"	250				15
	DF216/3	163	3/8"					
	DF216/4	164	1/2"					
	DF216/5	165	5/8"	500				10
	DF230/3	303	3/8"					
	DF230/4	304	1/2"					
	DF230/5	305	5/8"	670				6
DF241/5	415	5/8"						
DF241/6	416	3/4"						

(1)  
MWP = 680 psi in conformità a  
omologazione UL

(1)  
MWP = 680 psi according to UL approval

(1)  
MWP = 680 psi conformément à  
homologation UL

(1)  
MWP = 680 psi in Übereinstimmung zur  
UL-Zulassung

**FILTRI DISIDRATATORI A CARTUCCIA SOLIDA 80% SETACCIO MOLECOLARE, 20% ALLUMINA - ATTACCHI A SALDARE - OMOLOGATI DA UNDERWRITERS LABORATORIES INC.**  
**DEHYDRATOR FILTERS WITH SOLID CORE 80% MOLECULAR SIEVE, 20% ALUMINA - SOLDER CONNECTIONS - APPROVED BY UNDERWRITERS LABORATORIES INC.**  
**FILTRES DÉSHYDRATEURS AVEC CARTOUCHE SOLIDE 80% TAMIS MOLECULAIRE, 20% ALUMINE - RACCORDE A SOUDER - HOMOLOGUÉS PAR UNDERWRITERS LABORATORIES INC.**  
**FILTERTROCKNER MIT 80% MOLEKULARSIEB, 20% ALUMINIUMOXID - LÖTANSCHLÜSSE - ZUGELASSEN VON UNDERWRITERS LABORATORIES INC.**

POLYHEDRA

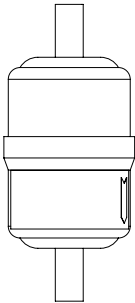
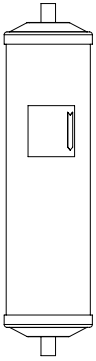
Disegno Drawing Dessin Zeichnung	N° catalogo Part number N° Catalogue Katalog Nr	Codice internazionale International code Code international Internationaler code	Attacchi Connections Raccords Anschlüsse		Cubatura nominale Nominal volume Cubature nominale Nominaler rauminhalt	PS [bar]	TS [°C]		Confezione n° pz Package pcs Emballage Verpackung
			ODS				Min	Max	
			Ø [in.]	Ø [mm]	[cm³]				
	DF203/2S	032S	1/4"	-	50	50 (1)	-40	+80	25
	DF203/3S	033S	3/8"	-					25
	DF205/2S	052S	1/4"	-	80				25
	DF205/3S	053S	3/8"	-					
	DF205/M10S	-	-	10					
	DF208/2S	082S	1/4"	-	130				25
	DF208/3S	083S	3/8"	-					
	DF208/M10S	-	-	10					
	DF208/M12S	-	-	12					
	DF208/4S	084S	1/2"	-					
	DF216/3S	163S	3/8"	-	250				15
	DF216/M10S	-	-	10					
	DF216/M12S	-	-	12					
	DF216/4S	164S	1/2"	-					
	DF216/5S	165S	5/8"	16					
	DF216/7S	167S	7/8"	-					
	DF230/3S	303S	3/8"	-	500				10
	DF230/4S	304S	1/2"	-					
	DF230/5S	305S	5/8"	16					
	DF230/7S	307S	7/8"	-					
DF241/5S	415S	5/8"	16	670	6				
DF241/6S	416S	3/4"	-						
DF241/7S	417S	7/8"	-						
	<b>NEW</b> 4275N/4S (2)	754S	1/2"	-	1340	50			1
	<b>NEW</b> 4275N/5S (2)	755S	5/8"	16					
	<b>NEW</b> 4275N/6S (2)	756S	3/4"	-					
	<b>NEW</b> 4275N/7S (2)	757S	7/8"	-					
	<b>NEW</b> 4275N/9S (2)	759S	1.1/8"	-					

(1): MWP = 680 psi in conformità a omologazione UL

(2): non omologato UL

(1): MWP = 680 psi according to UL approval

(2): not UL approved

(1): Pression minimale à laquelle la vanne est entièrement ouverte

(2): Pas approuvé UL

(1): MWP = 680 psi in Übereinstimmung zur UL-Zulassung

(2): Ohne UL-Zertifizierung

**FILTRI DISIDRATATORI A CARTUCCIA SOLIDA 100% SETACCIO MOLECOLARE - CONFORMITÀ ATEX PER USO IN EX ZONA 2**  
**SOLID CORE FILTER DRIERS 100% MOLECULAR SIEVES - ATEX CONFORMITY FOR USE IN EX ZONE 2**  
**FILTRES DÉSHYDRATEURS AVEC CARTOUCHE SOLIDE 100% TAMIS MOLECULAIRE - CONFORMITÉ ATEX POUR UTILISATION EN ZONE EX 2**  
**FILTERTROCKNER MIT 100% MOLEKULARSIEB - ATEX-KONFORMITÄT FÜR DEN EINSATZ IN EX-ZONE 2**

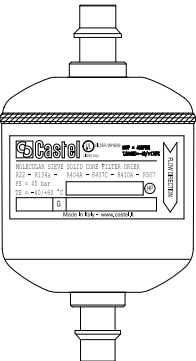
Disegno Drawing Dessin Zeichnung	N° catalogo Part number N° Catalogue Katalog Nr	Codice internazionale International code Code international Internationaler code	Attacchi Connections Raccords Anschlüsse				Cubatura nominale Nominal volume Cubature nominale Nominaler rauminhalt [cm³]	PS [bar]	TS [°C]		Confezione n° pz Package pcs Emballage Verpackung	
			ODS		ODM				Min	Max		
			Ø [in.]	Ø [mm]	Ø [in.]	Ø [mm]						
	4303EX/2S	032S	1/4"	-	3/8"	-	50	45	-40	+80	45	
	4305EX/3S	053S	3/8"	-	1/2"	-	80				34	
	4305EX/M10S	-	-	10	-	12	130				24	
	4308EX/3S	083S	3/8"	-	1/2"	-						
	4308EX/M10S	-	-	10	-	12						
	4308EX/M12S	-	-	12	-	14	250				28	
	4308EX/4S	084S	1/2"	-	5/8"	16						
	4316EX/3S	163S	3/8"	-	1/2"	-						
	4316EX/M10S	-	-	10	-	12	500				12	
	4316EX/M12S	-	-	12	-	14						
	4316EX/4S	164S	1/2"	-	5/8"	16						
	4316EX/5S	165S	5/8"	16	3/4"	-	670				14	
	4330EX/4S	304S	1/2"	-	5/8"	16						
	4330EX/5S	305S	5/8"	16	3/4"	-						
	4330EX/7S	307S	7/8"	-	1.1/8"	-	1340				24	1
	4330EX/9S	309S	1.1/8"	-	1.3/8"	-						
	4341EX/4S	414S	1/2"	-	5/8"	16						
	4341EX/5S	415S	5/8"	16	3/4"	-	1340				24	1
	4341EX/6S	416S	3/4"	-	7/8"	-						
	4341EX/7S	417S	7/8"	-	1.1/8"	-						
4375EX/7S	757S	7/8"	-	1.1/8"	-	1340	24	1				
4375EX/9S	759S	1.1/8"	-	1.3/8"	-							

FILTRI DISIDRATATORI A CARTUCCIA SOLIDA 100% SETACCIO MOLECOLARE, CON INDICATORE D'UMIDITÀ - ATTACCHI SAE FLARE OMOLOGATI DA UNDERWRITERS LABORATORIES INC.

SOLID CORE FILTER DRIERS 100% MOLECULAR SIEVES, WITH MOISTURE INDICATOR - SAE FLARE CONNECTIONS APPROVED BY UNDERWRITERS LABORATORIES INC.

FILTRES DÉSHYDRATEURS AVEC CARTOUCHE SOLIDE 100% TAMIS MOLECULAIRE, ET INDICATEUR D' HUMIDITE - RACCORDS SAE FLARE HOMOLOGUÉS PAR UNDERWRITERS LABORATORIES INC.

FILTERTROCKNER 100% MOLEKULARSIEB MIT FLÜSSIGKEITSINDIKATOR - BÖRDELANSCHLUSS ZUGELASSEN VON UNDERWRITERS LABORATORIES INC.

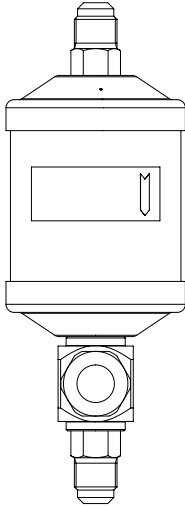
Disegno Drawing Dessin Zeichnung	N° Catalogo Part number N° Catalogue Katalog Nr		Codice internazionale International code Code international Internationaler code	Attacchi Connections Raccords Anschlüsse SAE Flare	Cubatura nominale Nominal volume Cubature nominale Nominaler rauminhalt [cm³]	PS [bar]	TS [°C]		Confezione n° pz Package pcs Emballage Verpackung		
							Min	Max			
	NEW	DI305N/2	052	1/4"	80	50 (1)	-40	+80	15		
	NEW	DI305N/3	053	3/8"							
	NEW	DI308N/2	082	1/4"	130				15		
	NEW	DI308N/3	083	3/8"							
	NEW	DI308N/4	084	1/2"							
	NEW	DI316N/2	162	1/4"	250				15		
	NEW	DI316N/3	163	3/8"							
	NEW	DI316N/4	164	1/2"							
	NEW	DI316N/5	165	5/8"							
	NEW	DI330N/3	303	3/8"	500					1	
	NEW	DI330N/4	304	1/2"							
	NEW	DI330N/5	305	5/8"							
	NEW	DI330N/6	306	3/4"							
	NEW	DI341N/5	415	5/8"	670						1
	NEW	DI341N/6	416	3/4"							

(1) MWP = 680 psi in conformità a omologazione UL

(1) MWP = 680 psi according to UL approval

(1) MWP = 680 psi conformément à homologation UL

(1) MWP = 680 psi in Übereinstimmung zur UL-Zulassung

FILTRI DISIDRATORI A CARTUCCIA SOLIDA 100% SETACCIO MOLECOLARE, CON INDICATORE D'UMIDITA' - ATTACCHI A SALDARE OMOLOGATI DA UNDERWRITERS LABORATORIES INC.

SOLID CORE FILTER DRIERS 100% MOLECULAR SIEVES, WITH MOISTURE INDICATOR - SOLDER CONNECTIONS APPROVED BY UNDERWRITERS LABORATORIES INC.

FILTRES DÉSHYDRATEURS AVEC CARTOUCHE SOLIDE 100% TAMIS MOLECULAIRE, ET INDICATEUR D' HUMIDITE - RACCORDS A SOUDER HOMOLOGUÉS PAR UNDERWRITERS LABORATORIES INC.

FILTERTROCKNER 100% MOLEKULARSIEB MIT FLÜSSIGKEITSINDIKATOR - LÖTANSCHLUSS ZUGELASSEN VON UNDERWRITERS LABORATORIES INC.

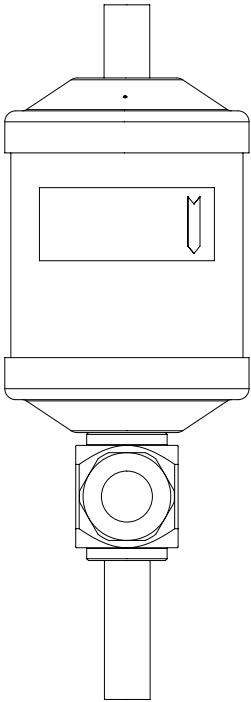
Disegno Drawing Dessin Zeichnung	N° Catalogo Part number N° Catalogue Katalog Nr	Codice internazionale International code Code international Internationaler code	TS [°C]		Cubatura nominale Nominal volume Cubature nominale Nominaler rauminhalt [cm³]	PS [bar]	TS [°C]		Confezione n° pz Package pcs Emballage Verpackung	
			Min	Max			Min	Max		
	NEW	DI305N/2S	052S	1/4"	-	80	50 (1)	-40	+80	15
	NEW	DI305N/3S	053S	3/8"	-					
	NEW	DI305N/M10S	-	-	10					
	NEW	DI308N/2S	082S	1/4"	-	130				
	NEW	DI308N/3S	083S	3/8"	-					
	NEW	DI308N/M10S	-	-	10					
	NEW	DI308N/M12S	-	-	12	250				
	NEW	DI308N/4S	084S	1/2"	-					
	NEW	DI316N/3S	163S	3/8"	-					
	NEW	DI316N/M10S	-	-	10					
	NEW	DI316N/M12S	-	-	12					
	NEW	DI316N/4S	164S	1/2"	-	500				
	NEW	DI316N/5S	165S	5/8"	16					
	NEW	DI316N/7S	167S	7/8"	-					
	NEW	DI330N/3S	303S	3/8"	-	670				
	NEW	DI330N/4S	304S	1/2"	-					
	NEW	DI330N/5S	305S	5/8"	16					
	NEW	DF330N/6S	306S	3/4"	-					
	NEW	DI330N/7S	307S	7/8"	-	670				
	NEW	DI341N/4S	414S	1/2"	-					
NEW	DI341N/5S	415S	5/8"	16						
NEW	DI341N/6S	416S	3/4"	-						
NEW	DI341N/7S	417S	7/8"	-	670	1				

(1) MWP = 680 psi in conformità a omologazione UL

(1) MWP = 680 psi according to UL approval

(1) MWP = 680 psi conformément à homologation UL

(1) MWP = 680 psi in Übereinstimmung zur UL-Zulassung



**FILTRI DISIDRATORI BIFLUSSO A CARTUCCIA SOLIDA 100% SETACCIO MOLECOLARE - ATTACCHI SAE FLARE - OMOLOGATI DA UNDERWRITERS LABORATORIES INC.**  
**SOLID CORE BI-FLOW FILTER DRIERS 100% MOLECULAR SIEVES - SAE FLARE CONNECTIONS - APPROVED BY UNDERWRITERS LABORATORIES INC.**  
**FILTRES DÉSHYDRATEURS BIDIRECTIONNELS AVEC CARTOUCHE SOLIDE 100% TAMIS MOLECULAIRE - RACCORDS SAE FLARE - HOMOLOGUÉS PAR UNDERWRITERS LABORATORIES INC.**  
**BI-FLOW FILTERTROCKNER 100% MOLEKULARSIEB - BÖRDELANSCHLUSS - ZUGELASSEN VON UNDERWRITERS LABORATORIES INC.**

Disegno Drawing Dessin Zeichnung	N° catalogo Part number N° Catalogue Katalog Nr	Codice internazionale International code Code international Internationaler code	Attacchi Connections Raccords Anschlüsse SAE Flare Ø [in.]	Cubatura nominale Nominal volume Cubature nominale Nominaler rauminhalt [cm³]	PS [bar]	TS [°C]		Confezione n° pz Package pcs Emballage Verpackung	
						Min	Max		
	DB305/2	052	1/4"	80	50 (1)	-40	+80	25	
	DB308/3	083	3/8"	130				25	
	DB308/4	084	1/2"						
	DB316/3	163	3/8"	250					15
	DB316/4	164	1/2"						
	DB316/5	165	5/8"						
	DB330/5	305	5/8"	500					

(1) MWP = 680 psi in conformità a omologazione UL

(1) MWP = 680 psi according to UL approval

(1) MWP = 680 psi conformément à homologation UL

(1) MWP = 680 psi in Übereinstimmung zur UL-Zulassung

**FILTRI DISIDRATORI BIFLUSSO A CARTUCCIA SOLIDA 100% SETACCIO MOLECOLARE - ATTACCHI A SALDARE - OMOLOGATI DA UNDERWRITERS LABORATORIES INC.**  
**SOLID CORE BI-FLOW FILTER DRIERS 100% MOLECULAR SIEVES - SOLDER CONNECTIONS - APPROVED BY UNDERWRITERS LABORATORIES INC.**  
**FILTRES DÉSHYDRATEURS BIDIRECTIONNELS AVEC CARTOUCHE SOLIDE 100% TAMIS MOLECULAIRE - RACCORDS A SOUDER - HOMOLOGUÉS PAR UNDERWRITERS LABORATORIES INC.**  
**BI-FLOW FILTERTROCKNER 100% MOLEKULARSIEB - LÖTANSCHLUSS - ZUGELASSEN VON UNDERWRITERS LABORATORIES INC.**

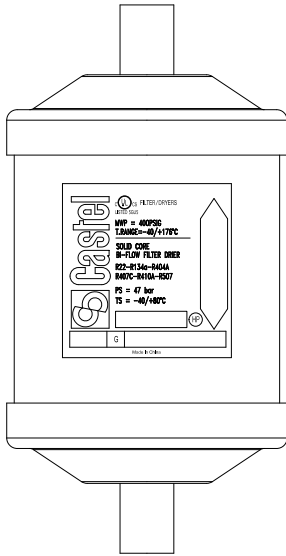
Disegno Drawing Dessin Zeichnung	N° catalogo Part number N° Catalogue Katalog Nr	Codice internazionale International code Code international Internationaler code	Attacchi Connections Raccords Anschlüsse		Cubatura nominale Nominal volume Cubature nominale Nominaler rauminhalt [cm³]	PS [bar]	TS [°C]		Confezione n° pz Package pcs Emballage Verpackung
			ODS				Min	Max	
			Ø [in.]	Ø [mm]					
	DB305/2S	052S	1/4"	-	80	50 (1)	-40	+80	25
	DB308/3S	083S	3/8"	-	130				25
	DB308/4S	084S	1/2"	-					
	DB316/3S	163S	3/8"	-	250				15
	DB316/4S	164S	1/2"	-					
	DB316/5S	165S	5/8"	16					
	DB316/7S	167S	7/8"	-					
	DB330/5S	305S	5/8"	16	500				10
	DB330/7S	307S	7/8"	-					
	DB330/9S	309S	1.1/8"	-					

(1)  
MWP = 680 psi in conformità a omologazione UL

(1)  
MWP = 680 psi according to UL approval

(1)  
MWP = 680 psi conformément à homologation UL

(1)  
MWP = 680 psi in Übereinstimmung zur UL-Zulassung

**FILTRI DISIDRATATORI A CARTUCCIA SOLIDA RICAMBIABILE- ATTACCHI D'ACCIAIO - OMOLOGATI DA UNDERWRITERS LABORATORIES INC.**  
**FILTER DRIERS WITH REPLACEABLE SOLID CORE - STEEL CONNECTIONS - APPROVED BY UNDERWRITERS LABORATORIES INC.**  
**FILTRES DÉSHYDRATEURS AVEC CARTOUCHE SOLIDE REMPLAÇABLE - RACCORDS EN ACIER - HOMOLOGUÉS PAR UNDERWRITERS LABORATORIES INC.**  
**FILTERTROCKNER FÜR UNIVERSAL BLOCKEINSATZ - STAHL-ANSCHLÜSSE - ZUGELASSEN VON UNDERWRITERS LABORATORIES INC.**

Disegno Drawing Dessin Zeichnung	N° Catalogo Part number N° Catalogue Katalog Nr	Attacchi Connections Raccords Anschlüsse			Tipo cartucce Cores type Type cartouches Patronentyp	N° cartucce N° of cores N° cartouches Patronenanzahl	Cubatura nominale Nominal volume Cubature nominale Nominaler rauminhalt [cm³]	PS [bar]	TS [°C]		Confezione n° pz Package pcs Emballage Verpackung		
		Coperchio filettato Threaded cover Couvercle fileté Schraubkappe		ODS					W	Min		Max	
		Ø [in.]	Ø [mm]	Ø [mm]									
	4411/5AF	5/8"	16	21,3	4490/A 4490/B 4490/AA 4490/AB	800	50 (1)	-40	+80	1			
	4411/7AF	7/8"	22	26,9									
	4411/9AF	1.1/8"	-	33,7									
	4411/11AF	1.3/8"	35	42,4									
	4411/13AF	1.5/8"	-	48,3									
	4411/M42AF	-	42	48,3									
	4411/17AF	2.1/8"	54	60,3									
	4412/7AF	7/8"	22	26,9									
	4412/9AF	1.1/8"	-	33,7									
	4412/11AF	1.3/8"	35	42,4									
	4412/13AF	1.5/8"	-	48,3									
	4412/M42AF	-	42	48,3									
	4412/17AF	2.1/8"	54	60,3									

(1) MWP = 470 psi in conformità a omologazione UL | (1) MWP = 470 psi according to UL approval | (1) MWP = 470 psi conformément à homologation UL | (1) MWP = 470 psi in Übereinstimmung zur UL-Zulassung

**ACCESSORI PER FILTRI 44**  
**ACCESSORIES FOR 44 FILTER DRIERS**  
**ACCESSOIRES POUR FILTRES 44**  
**ZUBEHÖR FÜR FILTERTROCKNER 44**

Disegno Drawing Dessin Zeichnung	N° catalogo Part number N° catalogue Katalog Nr	Componenti Parts Composant Komponenten	Confezione n° pz Package pcs. Emballage Verpackung
	7520/2	Tappo NPT NPT plug Bouchons NPT NPT Verschluss	25
	G9150/R05	Attacco di carica + meccanismo + cappuccio Access fitting + valve core + cap Raccords de charge + mécanismes+ capuchons Schraderventil + Ventileinsatz + Kappen	1

**CARTUCCE PER FILTRI DISIDRATATORI**  
**CARTRIDGES**  
**CARTOUCHE SOLIDE**  
**BLOCKEINSÄTZE**

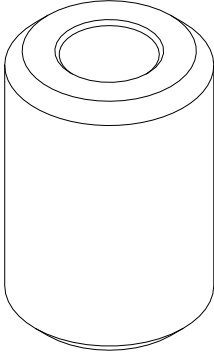
Disegno Drawing Dessin Zeichnung	N° catalogo Part number N° Catalogue Katalog Nr	Carica disidratante Dehydrating charge Charge déshydratant Bindemittel	Cubatura nominale Nominal volume Cubature nominale Nominaler rauminhalt [cm <sup>3</sup> ]	Adatta per filtri Suitable for filter Adapté pour filtre Passend für filter	Confezione n° pz Package pcs Emballage Verpackung
	4490/A (1)	100 % Setaccio molecolare 100% Molecular sieve 100% Tamis moleculaire 100% Molekularsieb	800	4411/AF 4412/AF	15
	4490/B (2)	100 % Setaccio molecolare 100% Molecular sieve 100% Tamis moleculaire 100% Molekularsieb	800	4411/AF 4412/AF	15
	4490/AA (1)	80% Setaccio molecolare + 20% allumina attivata 80% Molecular sieve + 20% activated alumina 80% Tamis moleculaire + 20% alumine activee 80% molekularsieb + 20% aktivem aluminium	800	4411/AF 4412/AF	15
	4490/AB (2)	80% Setaccio molecolare + 20% allumina attivata 80% Molecular sieve + 20% activated alumina 80% Tamis moleculaire + 20% alumine activee 80% molekularsieb + 20% aktivem aluminium	800	4411/AF 4412/AF	15

(1)  
Fornita con guarnizioni di ricambio del coperchio, sia per filtri Castel sia per filtri della concorrenza

(2)  
Fornita senza guarnizione di ricambio della controflangia del filtro

(1)  
Supplied with cover gasket as spare part, either for Castel filters or for competitors ones

(2)  
Supplied without cover gasket as spare part

(1)  
Fournie avec joints de rechange du couvercle aussi bien pour les filtres Castel que pour les filtres de la concurrence

(2)  
Fournie sans joint de rechange du couvercle du filtre

(1)  
Geliefert mit Ersatzdichtungen für den Deckel sowohl für Filter von Castel als auch Filter der Konkurrenz.

(2)  
Ohne Ersatzdichtung für Filtergegenflansch geliefert

FILTRI A CARTUCCIA MECCANICA RICAMBIABILE - ATTACCHI D'ACCIAIO E COPERCHIO FILETTATO - OMOLOGATI DA UNDERWRITERS LABORATORIES INC.

MECHANICAL FILTERS WITH REPLACEABLE FILTERING BLOCK - STEEL CONNECTIONS AND THREADED COVER - APPROVED BY UNDERWRITERS LABORATORIES INC.

FILTRES A CARTOUCHE MÉCANIQUE REMPLAÇABLES - RACCORDS EN ACIER ET COUVERCLE FILETÉ - HOMOLOGUÉS PAR UNDERWRITERS LABORATORIES INC.

MECHANISCHE SAUGLEITUNGSFILTER - STAHLANSCHLÜSSE UND SCHRAUBKAPPE - ZUGELASSEN VON UNDERWRITERS LABORATORIES INC.

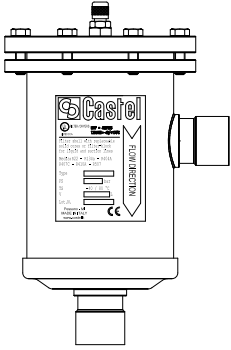
Disegno Drawing Dessin Zeichnung	N° catalogo Part number N° catalogue Katalog Nr	Attacchi Connections Raccords Anschlüsse			Tipo cartuccia Cartridge type Type cartouches Patrontyp	Superficie filtrante Filtering surface Surface filtrante Filterfläche [cm <sup>2</sup> ]	PS [bar]	TS [°C]		Confezione n° pz Package pcs Emballage Verpackung
		ODS		W				Min	Max	
		Ø [in.]	Ø [mm]	Ø [mm]						
	4411/5CF	5/8"	16	21,3	4495/C	820	50 (1)	-40	+80	1
	4411/7CF	7/8"	22	26,9						
	4411/9CF	1.1/8"	-	33,7						
	4411/11CF	1.3/8"	35	42,4						
	4411/13CF	1.5/8"	-	48,3						
	4411/M42CF	-	42	48,3						
	4411/17CF	2.1/8"	54	60,3						

(1) MWP = 470 psi in conformità a omologazione UL

(1) MWP = 470 psi according to UL approval

(1) MWP = 470 psi conformément à homologation UL

(1) MWP = 470 psi in Übereinstimmung zur UL-Zulassung

### CARTUCCE PER FILTRI MECCANICI BLOCKS

### CARTOUCHE POUR FILTRES MÉCANIQUE

### FILTEREINSATZ FÜR MECHANISCHE FILTER

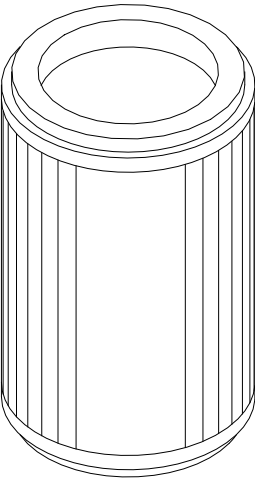
Disegno Drawing Dessin Zeichnung	N° catalogo N° catalogo N° Catalogue Katalog Nr	Superficie filtrante Filtering surface Surface filtrante Filterfläche [cm <sup>2</sup> ]	Per filtri Suitable for filter Pour filtre Für filter	Confezione n° pz Package pcs Emballage Verpackung
	4495/C	820	4411/_CF	15

**ACCESSORI  
ACCESSORIES  
ACCESSOIRES  
ZUBEHÖR**

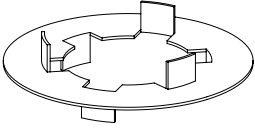
<b>Disegno Drawing Dessin Zeichnung</b>	<b>N° catalogo Part number N° catalogue Katalog Nr</b>	<b>Componenti Parts Composant Komponenten</b>	<b>Per filtri Suitable for filter Pour filtre Für filter</b>	<b>Confezione n° pz Package pcs. Emballage Verpackung</b>
	<p>9900/X74</p>	<p>Disco centratore per due cartucce meccaniche Centering disc for two blocks Disque de centrage pour deux cartouches Zentrierscheibe für zwei Filtereinsätze</p>	<p>4412/_AF (1)</p>	<p>1</p>

(1) sostituire componenti interni con ricambio 9151/R02

(1) replace internal components with spare part 9151 / R02

(1) remplacer les composants internes par la pièce de rechange 9151 / R02

(1) Ersetzen Sie die internen Komponenten durch das Ersatzteil 9151 / R02

**FILTRI A RETE  
STRAINERS  
FILTRES EN TAMIS MÉTALLIQUE  
NETZFILTER**

POLYHEDRA

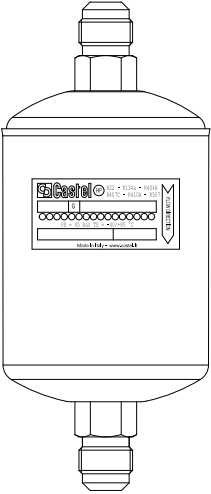
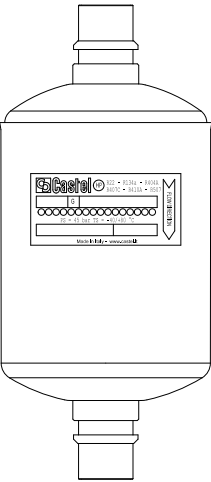
Disegno Drawing Dessin Zeichnung	N° catalogo Part number N° Catalogue Katalog Nr	Attacchi Connections Raccords Anschlüsse					Superficie filtrante Filtering surface Surface filtrante Filterflaeche [cm <sup>2</sup> ]	Kv [m <sup>3</sup> /h]	PS [bar]	TS [°C]		Confezione n° pz Package pcs Emballage Verpackung
		SAE Flare	ODS		ODM					Min	Max	
			Ø [in.]	Ø [mm]	Ø [in.]	Ø [mm]						
	4510/3	3/8"	-	-	-	-	58	2,4	45	-40	+80	34
	4510/4	1/2"	-	-	-	-	142	3,2				28
	4520/2	-	1/4"	-	3/8"	-	58	2,4	45	-40	+80	34
	4520/3	-	3/8"	-	1/2"	-		2,4				34
	4520/M10	-	-	10	-	12		2,4				34
	4520/M12	-	-	12	-	14		3,4				34
	4520/4	-	1/2"	-	5/8"	16		3,4				34
	4520/5	-	5/8"	16	3/4"	-		3,4				34
	4520/M18	-	-	18	-	22	142	8				28

**FILTRI A RETE  
STRAINERS  
FILTRES EN TAMIS MÉTALLIQUE  
NETZFILTER**

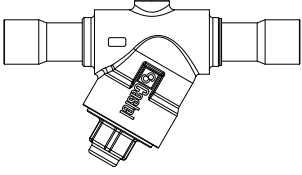
Disegno Drawing Dessin Zeichnung	N° catalogo Part number N° Catalogue Katalog Nr	Attacchi Connections Raccords Anschlüsse		Superficie filtrante Filtering surface Surface filtrante Filterflaeche [cm <sup>2</sup> ]	Luce maglia Mesh-opening Entraxe mailles Maschenweite [mm]	Kv [m <sup>3</sup> /h]	PS [bar]	TS [°C]		Confezione n° pz Package pcs Emballage Verpackung
		ODS						Min	Max	
		Ø [in.]	Ø [mm]							
	4720N/3	3/8"	-	13	0,1	2	50	-40	+150	15
	4720N/M10	-	10			2,5				
	4720N/M12	-	12							
	4720N/4	1/2"	-							
	4720N/5	5/8"	16	18	0,2	3				15
	4720N/M18	-	18			6				
	4720N/6	3/4"	-							
	4720N/7	7/8"	22			7				8
	4720N/M28	-	28							
	4720N/9	1.1/8"	-							
	4720N/11	1.3/8"	35			31				10
	4720N/13	1.5/8"	-	46						
	4720N/M42	-	42							
	4720N/17	2.1/8"	54	60	15	1				

**VALVOLE TARATE PER RISERVA D'OLIO  
OIL RESERVOIR PRESSURE VALVES  
CLAPETS TARÉ POUR RÉSERVOIR D'HUILE  
DRUCKVENTILE FÜR ÖLSAMMELGEFÄSS**

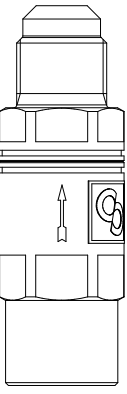
Disegno Drawing Dessin Zeichnung	N° Catalogo Part number N° Catalogue Katalog nr	Attacchi connections Raccords Anschlüsse SAE FLARE		Kv [m <sup>3</sup> /h]	pressione differenziale differential pressure Pression différentielle Differenzial Druck [bar]	PS [bar]	TS [°C]		Confezione n° pezzi Package pcs Emballage Verpackung
		IN	OUT				Min	Max	
	3150W/X01				0,35	50			
	3150W/X02	3/8" - F	3/8" - M	1,6	1,4	80	-40	+150	20
	3150W/X03				3				

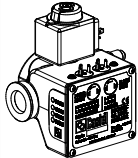
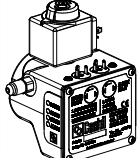

**REGOLATORI ELETTRONICI DI LIVELLO DELL'OLIO**  
**ELECTRONIC OIL LEVEL REGULATORS**  
**RÉGULATEURS DE NIVEAU D'HUILE ÉLECTRONIQUE**  
**ELEKTRONISCHEN ÖLSPIEGELREGULATOREN**

Disegno Drawing Dessin Zeichnung	N° catalogo Part number N° catalogue Katalog Nr	Attacchi Connections Raccords Anschlüsse			Versione Version Modél Ausführung	Tensione Voltage Tension Spannung [V]	Frequenza Frequency Fréquence Frequenz [Hz]	Grado di protezione Degree of protection Degrè de protection Schutzgrad	Kit cavi Cables kit Câbles kit Kabel-Kit (1)	PS [bar]	TS [°C]		Confezione n° pz Package pcs Emballage Verpackung									
		Adattatori carter compressore Compressor crankcase adapters Adaptateurs de carter du compresseur Kompressor-Kurbelgehäuse-Adapter (1)	Spia livello olio Oil level inspection Hublot de contrôle de niveau d'huile Ölschauglas	Ingresso olio Oil inlet Entree d'huile Öleintritt SAE FLARE							Min	Max										
	5650/RA2	5690/X11 5690/X12 5690/X13 5690/X14 5690/X15 5690/X16	1 spia di livello 1 sight glass 1 indicateur 1 Schauglas	3/8"	Destro Right Droit Recht	24 AC	50/60	IP 65	9901/ X26	50	-30	+130	1									
	5650/RA6					220 AC	50/60															
	5650/LA2				5690/X11 5690/X12 5690/X13 5690/X14 5690/X15 5690/X16	1 spia di livello 1 sight glass 1 indicateur 1 Schauglas	3/8"							Sinistro Left Gauche Link	24 AC	50/60	IP 65	9901/ X26	50	-30	+130	1
	5650/LA6														220 AC	50/60						

(1) Da ordinare separatamente

(1) To be ordered separately

(1) Doit être commandé séparément

(1) Sind separat zu bestellen

**KIT CAVI**  
**CABLES KIT**  
**CÂBLES KIT**  
**KABEL-KIT**

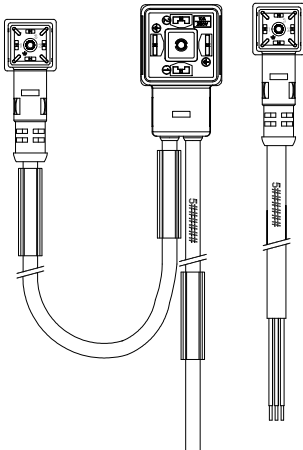
Disegno Drawing Dessin Zeichnung	N° Catalogo Part number N° Catalogue Katalog Nr	Impiego Use Usage Benutzen	Grado di protezione Degree of protection Degrè de protection Schutz - klasse	Lunghezza cavo Cable length Longueur du câble Kabellänge [m]	Confezione n° pz Package pcs Emballage Verpackung
	9901/X26	Cavo alimentazione Power supply cable Câble d'alimentation Stromversorgungskabel	IP 65	3	1
		Cavo allarmi Alarms cable câble alarmes Alarmkabel	IP 65	3	

**ADATTATORI PER REGOLATORI DI LIVELLO DELL'OLIO**  
**OIL LEVEL REGULATORS ADAPTERS**  
**ADAPTATEURS POUR RÉGULATEURS DE NIVEAU D'HUILE**  
**ADAPTER FÜR ÖLSPIEGELREGULATOR-**

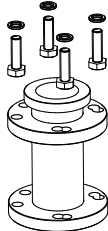
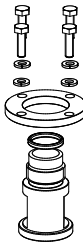
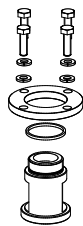
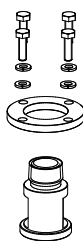
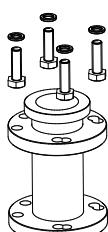
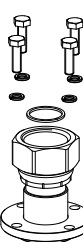
Disegno Drawing Dessin Zeichnung	N° catalogo Part number N° catalogue Katalog Nr	Attacchi carter compressore Compressor crankcase connections Raccords carter du compresseur Verdichter-Kurbelgehäuse Anschlüsse	Confezione n° pz Package pcs Emballage Verpackung
	5690/X11	Flangiato con 3 fori su Ø 1.7/8 e 4 fori su Ø 50 mm Flanged with 3 holes on dia 1.7/8" and 4 holes on dia 50 mm Joint torique avec 3 trous sur Ø 1.7/8 et 4 trous sur Ø 50 mm Flansch mit 3 Löcher vom Ø 1.7/8" und 4 Löcher vom Ø 50 mm L = 83 mm	1
	5690/X12	Filettato 1.1/8" - 12 UNF 1.1/8" - 12 UNF thread Fileté 1.1/8" - 12 UNF Gewinde 1.1/8" - 12 UNF	1
	5690/X13	Filettato 1.1/8" - 18 UNEF 1.1/8" - 18 UNEF thread Fileté 1.1/8" - 18 UNEF Gewinde 1.1/8" - 18 UNEF	1
	5690/X14	Filettato 3/4" NPT 3/4" NPT thread Fileté 3/4" NPT Gewinde 3/4" NPT	1
	5690/X15	Flangiato con 3 fori su Ø 1.7/8 e 4 fori su Ø 50 mm Flanged with 3 holes on dia 1.7/8" and 4 holes on dia 50 mm Joint torique avec 3 trous sur Ø 1.7/8 et 4 trous sur Ø 50 mm Flansch mit 3 Löcher vom Ø 1.7/8" und 4 Löcher vom Ø 50 mm L = 53 mm	1
	5690/X16	Rotalock 1.1/4" - 12 UNF	1

**RUBINETTI PER SISTEMI FRIGORIFERI ERMETICI**  
**VALVES FOR HERMETIC SYSTEMS**  
**VANNES PUOR INSTALLATIONS DE GROUPES HERMÉTIQUES**  
**KLEINVENTILE FÜR HERMETISCHE KÄELTEANLAGEN**

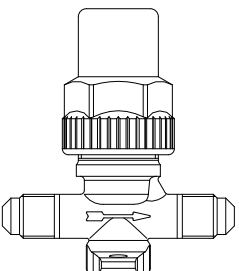
Disegno Drawing Dessin Zeichnung	N° catalogo Part number N° Catalogue Katalog Nr	Att. Carica Access fitting Raccord chargement Fullanschlüss SAE Flare	Attacchi Connections Raccords Anschlüsse				Kv [m <sup>3</sup> /h]	PS [bar]	TS [°C]		Confezione n° pz Package pcs Emballage Verpackung
			SAE Flare		ODS				Min	Max	
			1/4"	1/4"	Ø [in.]	Ø [mm]					
	6010N/2	-	1/4"	1/4"	-	-	0,27	50	-40	+150	45
	6012N/22	-	1/4"	-	1/4"	-					72

**RUBINETTI PER SERBATOIO**  
**RECEIVER VALVES**  
**VANNES DEPART LIQUIDE**  
**SAMMLER VENTILE**

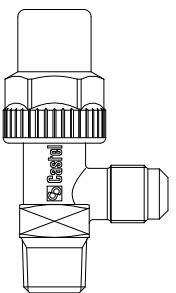
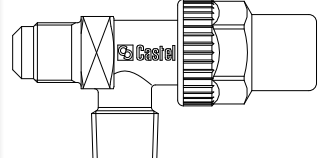
Disegno Drawing Dessin Zeichnung	N° catalogo Part number N° Catalogue Katalog Nr	Att. Carica Access fitting Raccord chargement Fullanschlüss SAE Flare	Attacchi Connections Raccords Anschlüsse		Kv [m <sup>3</sup> /h]	PS [bar]	TS [°C]		Confezione n° pz Package pcs Emballage Verpackung
			SAE Flare	NPT			Min	Max	
			1/4"	1/4"					
	6110N/22	-	1/4"	1/4"	0,44	50	-40	+150	90
	6110N/X15	1/4" f	1/4"	-	0,44				
	6110N/23	-	1/4"	3/8"	0,45				
	6110N/32	-	3/8"	1/4"	1,35				
	6110N/33	-	3/8"	3/8"	1,35				
	6110N/X13	3/8" f	3/8"	-	1,35				
	6110N/43	-	1/2"	3/8"	2,4				
	6110N/44	-	1/2"	1/2"	3,4				
	6120N/22	-	1/4"	1/4"	0,44	50	-40	+150	90
	6120N/23	-	1/4"	3/8"	0,45				
	6120N/32	-	3/8"	1/4"	1,35				
	6120N/33	-	3/8"	3/8"	1,35				
	6120N/43	-	1/2"	3/8"	2,4				
	6120N/44	-	1/2"	1/2"	3,4				

**RUBINETTI A CAPPELLOTTA**  
**CAPPED VALVES**  
**VANNES A CAPOUCHON**  
**KAPPENVENTILE**

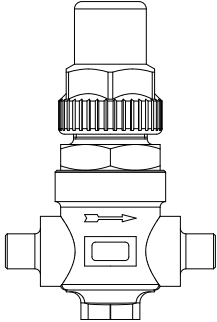
Disegno Drawing Dessin Zeichnung	N° catalogo Part number N° Catalogue Katalog Nr	Attacchi Connections Raccords Anschlüsse			Kv [m³/h]	PS [bar]	TS [°C]		Confezione n° pz Package pcs Emballage Verpackung
		SAE Flare	ODS				Min	Max	
			Ø [in.]	Ø [mm]					
	6420N/2	-	1/4"	-	0,4	50	-40	+130	45
	6420N/3	-	3/8"	-	1				
	6420N/3S3	3/8" - OUT	3/8" - IN	-	1				
	6420N/4	-	1/2"	-	1,45				

**RUBINETTI A SFERA**  
**BALL VALVES**  
**VANNES A BOISSEAU SPHÉRIQUE**  
**KUGELABSPERRVENTILE**

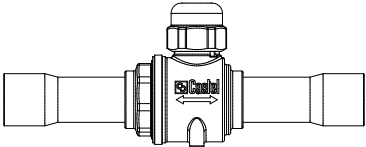
Disegno Drawing Dessin Zeichnung	N° catalogo Part number N° Catalogue Katalog Nr	Attacchi Connections Raccords Anschlüsse		Foro Sfera Ø Ball port Ø Orifice bille Ø Bohrung Ø [mm]	Kv [m³/h]	PS [bar]	TS [°C]		Confezione n° pz Package pcs Emballage Verpackung			
		ODS					min.	max.				
		Ø [in.]	Ø [mm]									
	6570N/M6	-	6	10	0,8	50	-40	+150	25			
	6570N/2	1/4"	-		3							
	6570N/3	3/8"	-									
	6570N/M10	-	10									
	6570N/M12	-	12		5							
	6570N/4	1/2"	-									
	6571N/5	5/8"	16	15					17	16		
	6570N/M15	-	15									
	6570N/5	5/8"	16									
	6570N/M18	-	18		19						29	21
	6570N/6	3/4"	-									
	6571N/7	7/8"	22									
	6570N/7	7/8"	22	25	51				16			
	6571N/M28	-	28									
	6571N/9	1.1/8"	-							40	117	6
	6570N/M28	-	28									
	6570N/9	1.1/8"	-									
	6571N/11	1.3/8"	35	50	214				1			
	6570N/11	1.3/8"	35									
	6570N/13	1.5/8"	-									
6570N/M42	-	42	60	380								
6570N/17	2.1/8"	54										
6570N/M64	-	64										

**RUBINETTI A SFERA CON ATTACCO DI CARICA**  
**BALL VALVES WITH ACCESS FITTING**  
**VANNES A BOISSEAU SPHÉRIQUE AVEC RACCORD DE CHARGE**  
**KUGELABSPERRVENTILE MIT SCHRADER**

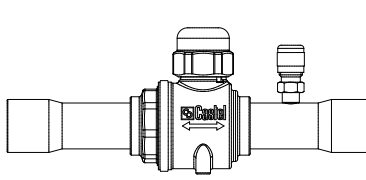
Disegno Drawing Dessin Zeichnung	N° catalogo Part number N° Catalogue Katalog Nr	Attacchi Connections Raccords Anschlüsse		Foro Sfera Ø Ball port Ø Orifice bille Ø Bohrung Ø [mm]	Kv [m³/h]	PS [bar]	TS [°C]		Confezione n° pz Package pcs Emballage Verpackung		
		ODS					min.	max.			
		Ø [in.]	Ø [mm]								
	6570N/M6A	–	6	10	0,8	50	-40	+150	25		
	6570N/2A	1/4"	–		15					3	
	6570N/3A	3/8"	–							5	
	6570N/M10A	–	10							17	29
	6570N/M12A	–	12								
	6570N/4A	1/2"	–								
	6570N/M15A	–	15	21							
	6570N/5A	5/8"	16								
	6570N/M18A	–	18	25	51	16					
	6570N/6A	3/4"	–								
	6570N/7A	7/8"	22	32	86	6					
	6570N/M28A	–	28								
	6570N/9A	1.1/8"	–	40	117	6					
	6570N/11A	1.3/8"	35								
	6570N/13A	1.5/8"	–	50	214	6					
	6570N/M42A	–	42								
	6570N/17A	2.1/8"	54	60	380	1					
	6570N/M64A	–	64								
	6570N/21A	2.5/8"	–	73	550	1					
	6570N/24A	3"	76								
6570N/25A	3.1/8"	80	82	710	35						
6570N/28A	3.1/2"	89									
6570N/29A	3.5/8"	92									

**RUBINETTI A 3-VIE MANUALI**  
**3-WAY MANUAL VALVES**  
**VANNES MANUELLES À 3 VOIES**  
**3-WEGE-HANDVENTILE**

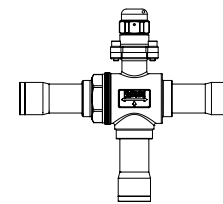
Disegno Drawing Dessin Zeichnung	N° catalogo Part number N° Catalogue Katalog Nr	Attacchi Connections Raccords Anschlüsse		Foro Sfera Ø Ball port Ø Orifice bille Ø Bohrung Ø [mm]	Kv [m³/h]	PS [bar]	TS [°C]		Confezione n° pz Package pcs Emballage Verpackung
		ODS					min.	max.	
		Ø [in.]	Ø [mm]						
	6690N/7	7/8"	22	19	10,7	50	-40	+150	1
	6690N/M28	–	28	24	15,9				
	6690N/9	1.1/8"	–	24	15,9				
	6690N/11	1.3/8"	35	28	20,3				
	6690N/13	1.5/8"	–	37	38,5				
	6690N/M42	–	42	37	38,5				

**RUBINETTI A 3-VIE DA MOTORIZZARE**  
**3-WAY VALVES TO BE MOTORIZED**  
**VANNES À 3 VOIES À MOTORISER**  
**3-WEGE-VENTILE, DIE MOTORISIERT WERDEN**

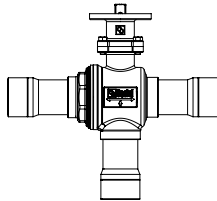
Disegno Drawing Dessin Zeichnung	N° catalogo Part number N° Catalogue Katalog Nr (1)	Attacchi Connections Raccords Anschlüsse		Foro Sfera Ø Ball port Ø Orifice bille Ø Bohrung Ø [mm]	Kv [m³/h]	PS [bar]	TS [°C]		Confezione n° pz Package pcs Emballage Verpackung
		ODS					min.	max.	
		Ø [in.]	Ø [mm]						
	6690NB/7	7/8"	22	19	10,7	50	-40	+150	1
	6690NB/M28	-	28	24	15,9				
	6690NB/9	1.1/8"	-	24	15,9				
	6690NB/11	1.3/8"	35	28	20,3				
	6690NB/13	1.5/8"	-	37	38,5				
	6690NB/M42	-	42	37	38,5				

(1)  
completo di adattatore per servomotore  
BELIMO

(1)  
with adapter for BELIMO actuator

(1)  
avec adaptateur pour servomoteur BELIMO

(1)  
mit Adapter für BELIMO-Antrieb

**RUBINETTI A 3-VIE MOTORIZZATI**  
**3-WAY MOTORIZED VALVES**  
**3-VOIES VANNES MOTORISÉ**  
**3 WEGE MOTORVENTILE**

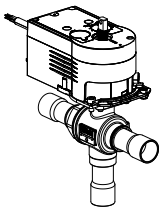
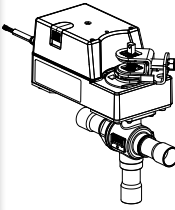

Disegno Drawing Dessin Zeichnung	N° catalogo Part number N° Catalogue Katalog Nr (1)	Attacchi Connections Raccords Anschlüsse		Potenza Power Puissance Leistung [W]	Foro Sfera Ø Ball port Ø Orifice bille Ø Bohrung Ø [mm]	Kv [m³/h]	Coppia Torque Couple Drehmoment [Nm]	Tempo di marcia Running time Durée de course Laufzeit [sec]	TS [°C]		Confezione n° pz Package pcs Emballage Verpackung	
		ODS							min.	max.		
		Ø [in.]	Ø [mm]									
	6690NM/7A2 (2)	7/8"	22	4,8	19	10,7	10	60	50	-40	+150	1
	6690NM/7A6 (3)			2,9								
	6690NM/M28A2 (2)	-	28	4,8	24	15,9						
	6690NM/M28A6 (3)			2,9								
	6690NM/9A2 (2)	1.1/8"	-	4,8	24	15,9						
	6690NM/9A6 (3)			2,9								
	6690NM/11A2 (2)	1.3/8"	35	2,4	28	20,3	30	120	50	-40	+150	1
	6690NM/11A6 (3)			3,7								
	6690NM/13A2 (2)	1.5/8"	-	2,4	37	38,5						
	6690NM/13A6 (3)			3,7								
	6690NM/M42A2 (2)	-	42	2,4	37	38,5						
	6690NM/M42A6 (3)			3,7								

(1)  
completo di attuatore e piastra di montaggio

(1)  
with actuator and mounting plate

(1)  
avec servomoteur et la plaque de montage

(1)  
mit Stellantrieb und Montageplatte

(2)  
- Tensione = 24 V  
- Frequenza = 50/60 Hz  
- Grado di protezione = IP 54  
- Angolo di manovra = 90°  
- Connessioni elettriche : uscita in commutazione a 2 punti (aperto/chiuso) oppure uscita in continua (0 ÷ 10V)

(2)  
- Voltage = 24 V  
- Frequency = 50/60 Hz  
- Degree of protection = IP 54  
- Rotation angle = 90°  
- Wiring connections : switching output 2 points (open/close) or continuous output (0 ÷ 10V)

(2)  
- Tension = 24 v  
- Fréquence = 50/60 Hz  
- Degré de protection = IP 54  
- Angle de rotation = 90°  
- Connexions électriques : sortie à contacts à 2 points (ouvert/fermé) ou sortie progressive (0 ÷ 10V)

(2)  
- Spannung = 24 V  
- Frequenz = 50/60 Hz  
- Schutzgrad = IP 54  
- Drehwinkel = 90°  
- Anschlussplan : Schaltendem Ausgang 2 Punkt (offen/geschlossen) oder Stetigem Ausgang (0 ÷ 10V)

(3)  
- Tensione = 230 V  
- Frequenza = 50/60 Hz  
- Grado di protezione = IP 43  
- Angolo di manovra = 90°  
- Connessioni elettriche : uscita in commutazione a 2 punti (aperto/chiuso)

(3)  
- Voltage = 230 V  
- Frequency = 50/60 Hz  
- Degree of protection = IP 43  
- Rotation angle = 90°  
- Wiring connections : switching output 2 points (open/close)

(3)  
- Tension = 230 V  
- Fréquence = 50/60 Hz  
- Degré de protection = IP 43  
- Angle de rotation = 90°  
- Connexions électriques : sortie à contacts à 2 points (ouvert/fermé)

(3)  
- Spannung = 230 V  
- Frequenz = 50/60 Hz  
- Schutzgrad = IP 43  
- Drehwinkel = 90°  
- Anschlussplan : Schaltendem Ausgang 2 Punkt (offen/geschlossen)

**SERVOMOTORI  
ACTUATORS  
SERVOMOTEUR  
STELLANTRIEB**

POLYHEDRA

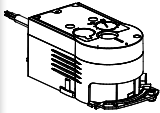
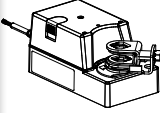
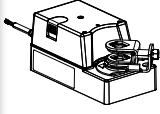
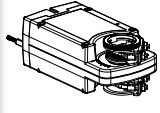
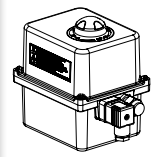
Disegno Drawing Dessin Zeichnung	N° catalogo Part number N° Catalogue Katalog Nr	Tensione Voltage Tension Spannung	Frequenza Frequency Fréquence Frequenz	Potenza Power Puissance Leistung	Grado di protezione Degree of protection Degré de protection Schutzgrad	Adatto per rubinetto Designed for valve Adapté pour vanne Passé für ventil	Angolo di manovra Rotation angle Angle de rotation Drehwinkel	Coppia Torque Couple Drehmoment	Tempo di marcia Running time Durée de course Laufzeit	Temperatura ambiente Ambient temperature Température ambiante Umgebungstemperatur		Confezione n° pz Package Pcs. Emballage Verpackung
		[°C]										
		[V]	[Hz]	[W]	min					Max		
	9700/RA2 (1)	24	50/60	4,8	IP 54	6570N/M6; 6570N/M6A; 6570N/3; 6570N/3A 6570N/M10; 6570N/M10A; 6570N/M12; 6570N/M12A 6570N/4; 6570N/4A, 6570N/M15, 6570N/M15A 6570N/5; 6570N/5A; 6570N/M18, 6570N/M18A 6570N/6; 6570N/6A; 6570N/7; 6570N/7A 6570N/M28; 6570N/M28A; 6570N/9; 6570N/9A 6571N/5; 6571N/7; 6571N/M28; 6571N/9; 6571N/11	90°	10	60	-20	+50	1
	9700/RA6 (2)	230	50/60	2,9	IP 43	6570N/7; 6570N/7A; 6570N/M28; 6570N/M28A 6570N/9; 6570N/9A; 6571N/M28; 6571N/9; 6571N/11						
	9720/RA2 (1)	24	50/60	2,4	IP 54	6570N/11; 6570N/11A 6570N/13; 6570N/13A 6570N/M42; 6570N/M42A	90°	30	120	-20	+50	1
	9720/RA6 (2)	230	50/60	3,7	IP 43							
	9730/RA2 (3)	24	50/60	9	IP 54	6570N/17; 6570N/17A	90°	60	150	-30	+50	1
	9730/RA6 (2)	230	50/60	9	IP 54							
	<b>NEW</b> 9740/RA2 (3)	24	50/60	45	IP 66	6570N/M64; 6570N/M64A 6570N/21A; 6570N/24A; 6570N/25A 6570N/28A; 6570N/29A	90°	100	120	-10	+55	1
	<b>NEW</b> 9740/RA6 (2)	230	50/60	45	IP 66							

(1)  
Connessioni elettriche: uscita in commutazione a 2 punti (aperto/chiuso) oppure uscita in continua (0 ÷ 10V)

(2)  
Connessioni elettriche: uscita in commutazione a 2 punti (aperto/chiuso)

(3)  
Connessioni elettriche: uscita in continua (0 ÷ 10V)

(1)  
Wiring connections: switching output 2 points (open/close) or continuous output (0 ÷ 10V)

(2)  
Wiring connections: switching output 2 points (open/close)

(3)  
Wiring connections: continuous output (0 ÷ 10V)

(1)  
Connexions électriques: sortie à contacts à 2 points (ouvert/fermé) ou sortie progressive (0 ÷ 10V)

(2)  
Connexions électriques: sortie à contacts à 2 points (ouvert/fermé)

(3)  
Connexions électriques: sortie progressive (0 ÷ 10V)

(1)  
Anschlussplan: Schaltendem Ausgang 2 Punkt (offen/geschlossen) oder Stetigem Ausgang (0 ÷ 10V)

(2)  
Anschlussplan: Schaltendem Ausgang 2 Punkt (offen/geschlossen)

(3)  
Anschlussplan: Stetigem Ausgang (0 ÷ 10V)

**CONTATTI AUSILIARI**  
**AUXILIARY SWITCH UNITS**  
**UNITÉ D'INTERRUPTEURS AUXILIAIRES**  
**HILFSSCHALTEREINHEIT**

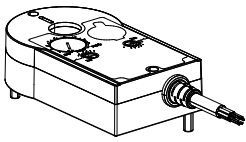
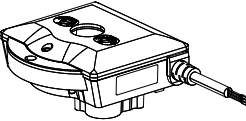
Disegno Drawing Dessin Zeichnung	N° catalogo Part number N° Catalogue Katalog Nr	Adatto per attuatore Designed for actuator Adapté pour servomoteur Passed für stellantrieb	Tipo contatto Contact type Type contact Kontakt Typ	Carico massimo Max loading Charge maximale Belastung [A]	Temperatura ambiente Ambient temperature Température ambiante Umgebungstemperatur [°C]		Grado di protezione Degree of protection Degrè de protection Schutzgrad	Confezione n° pz Package Pcs. Emballage Verpackung
					min	Max		
	9750/X01	9700/RA2	Doppio Double Double Dopplet	5	-20	+55	IP 40	1
	9750/X02	9700/RA6; 9720/RA2; 9720/RA6	Doppio Double Double Dopplet	5	-20	+55	IP 40	1

**ADATTATORI PER ATTUATORE**  
**SERVOMOTOR ADAPTERS**  
**ADAPTEURS POUR SERVOMOTEUR**  
**LOETADAPTERS FÜR STELLANTRIEB**

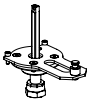
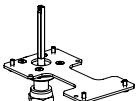
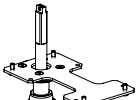
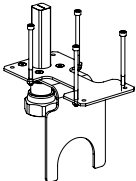
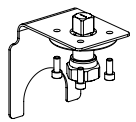
Disegno Drawing Dessin Zeichnung	N° catalogo Part number N° Catalogue Katalog Nr	Adatto per rubinetto Designed for valve Adapté pour vanne Passed für ventil	Adatto per attuatore Designed for actuator Adapté pour servomoteur Passed für stellantrieb	Confezione n° pz Package Pcs. Emballage Verpackung
	NEW 9901/X58	6570N/M6; 6570N/M6A; 6570N/3; 6570N/3A 6570N/M10; 6570N/M10A; 6570N/M12; 6570N/M12A; 6570N/4; 6570N/4A, 6570N/M15, 6570N/M15A; 6570N/5; 6570N/5A; 6570N/M18, 6570N/M18A; 6570N/6; 6570N/6A; 6571N/5; 6571N/7	9700/RA2	1
	NEW 9901/X60	6570N/7; 6570N/7A; 6570N/M28; 6570N/M28A; 6570N/9; 6570N/9A; 6571N/M28; 6571N/9; 6571N/11		
	NEW 9901/X57	6570N/7; 6570N/7A; 6570N/M28; 6570N/M28A 6570N/9; 6570N/9A; 6571N/M28; 6571N/9; 6571N/11	9700/RA6	1
	NEW 9901/X75	6570N/11; 6570N/11A; 6570N/13; 6570N/13A; 6570N/M42; 6570N/M42	9720/RA2 - 9720/RA6	1
	NEW 9901/X76	6570N/17; 6570N/17A	9730/RA2 - 9730/RA6	1
	NEW 9901/X70	6570N/M64; 6570N/M64A; 6570N/21A	9740/RA2 - 9740/RA6	1
	NEW 9901/X71	6570N/24A; 6570N/25A		
	NEW 9901/X72	6570N/28A; 6570N/29A		



**ANTIVIBRANTI, ATTACCHI ACCIAIO INOX**  
**VIBRATION ABSORBERS, STAINLESS STEEL CONNECTIONS**  
**ÉLIMINATEURS DE VIBRATIONS, CONNEXIONS EN ACIER INOXYDABLE**  
**SCHWINGUNGSDÄMPFER, EDELSTAHLVERBINDUNGEN**

Disegno Drawing Dessin Zeichnung	N° catalogo Part number N° Catalogue Katalog Nr		Attacchi Connections Raccords Anschlüsse		PS [bar]			Confezione n° pezzi Package pcs Emballage Verpackung
			ODS		TS [°C] -80 / +100	TS [°C] +120	TS [°C] +140	
			Ø [in.]	Ø [mm]				
	NEW	7690N/3	3/8"	-	50	49	48	100
	NEW	7690N/M10	-	10				
	NEW	7690N/M12	-	12				
	NEW	7690N/4	1/2"	-				
	NEW	7690N/M15	-	15				
	NEW	7690N/5	5/8"	16				
	NEW	7690N/M18	-	18				
	NEW	7690N/6	3/4"	-				
	NEW	7690N/7	7/8"	22				
	NEW	7690N/M28	-	28				
	NEW	7690N/9	1.1/8"	-				
	NEW	7690N/11	1.3/8"	35				
	NEW	7690N/13	1.5/8"	-				
	NEW	7690N/M42	-	42				
	NEW	7690N/17	2.1/8"	54				
								50
								25
								10
								5



(#)

Per applicazioni specifiche con fluidi refrigeranti non elencati sopra, prego contattare l'Ufficio Tecnico della Castel

For specific applications with refrigerant fluids not listed above, please contact Castel Technical Department

Pour des applications spécifiques avec des fluides frigorigènes non énumérés ci-dessus, s'il vous plaît contacter le service technique de la Castel

Für spezielle Anwendungen mit Kältemitteln nicht oben aufgeführt sind, kontaktieren Sie bitte Castel Technische Abteilung

**C L ▲ S S I C**

**REFRIGERANTI A1, ASHRAE STANDARD 34-2019<sup>(#)</sup>  
A1 REFRIGERANTS, ASHRAE STANDARD 34-2019<sup>(#)</sup>  
RÉFRIGÉRANTS A1, ASHRAE STANDARD 34-2019<sup>(#)</sup>  
A1 KALTEMITTEL, ASHRAE STANDARD 34-2019<sup>(#)</sup>**

**HCFC (R22)  
HFC (R134a, R404A, R407C, R410A, R507)  
HFO (R1234ze)  
HFO + HFC (R448A, R449A, R450A, R452A, R513A)**

**Castel<sup>®</sup>**  
Italian technology

**VALVOLE D'ESPANSIONE A SOLENOIDE CON ORIFIZIO INTERCAMBIABILE**  
**SOLENOID EXPANSION VALVES WITH INTERCHANGEABLE ORIFICE**  
**DÉTENDEURS À COMMANDE ÉLECTRIQUES AVEC ENSEMBLE ORICE INTERCHANGEABLE**  
**ELEKTRISCHE EXPANSIONSVENTILE MIT AUSTAUSCHBAREM DÜSENEINSATZ**



Disegno Drawing Dessin Zeichnung	N° catalogo Part number N° Catalogue Katalog Nr	Tipo orificio Orifice type Type d'orifice Düseneinsatz Typ	Attacchi Connections Raccords Anschlüsse				Kv [m³/h]	PS [bar]	TS [°C]		Confezione n° pz Package pcs. Emballage Verpackung
			In		Out				Min	Max	
			Ø [in.]	Ø [mm]	Ø [in.]	Ø [mm]					
	2028/3S01	01	3/8"	-	1/2"	-	0,010	45	-40	+100	17
	2028/M10S01		-	10	-	12					
	2028/3S02	02	3/8"	-	1/2"	-	0,017				
	2028/M10S02		-	10	-	12					
	2028/3S03	03	3/8"	-	1/2"	-	0,023				
	2028/M10S03		-	10	-	12					
	2028/3S04	04	3/8"	-	1/2"	-	0,043				
	2028/M10S04		-	10	-	12					
	2028/3S05	05	3/8"	-	1/2"	-	0,065				
	2028/M10S05		-	10	-	12					
	2028/3S06	06	3/8"	-	1/2"	-	0,113				
	2028/M10S06		-	10	-	12					
	2028/4S07	07	1/2"	-	5/8"	-	0,200				
	2028/M12S07		-	12	-	16					
	2028/4S08	08	1/2"	-	5/8"	-	0,230				
	2028/M12S08		-	12	-	16					
	2028/4S09	09	1/2"	-	5/8"	-	0,250				
	2028/M12S09		-	12	-	16					

per le potenzialità nominali vedere tabella dei gruppi orificio | for rated capacities see table of the orifice assemblies | pour les capacités nominales voir tableau des ensembles d'orifices | für Nennleistungen siehe Tabelle der Austrittsanordnungen

**GRUPPI ORIFICI**  
**ORIFICE ASSEMBLIES**  
**ENSEMBLES ORIFICE**  
**DÜSENEINSATZ**

Disegno Drawing Dessin Zeichnung	N° catalogo Part number N° catalogue Katalog Nr.	Tipo orificio Orifice type Type d'orifice Düseneinsatz Typ	Potenzialità nominali (1) Rated capacity (1) Capacités nominales (1) Nennleistungen (1) [kW]													Confezione n° pz Package pcs. Emballage Verpackung
			R134a	R22	R32	R404A R507	R407C	R410A	R1234ze	R1234yf	R448A	R449A	R450A	R452A	R513A	
	9150/R63	01	0,7	1,0	2,4	0,7	1,2	1,2	0,6	0,6	1,0	1,1	0,6	0,9	0,8	10
	9150/R64	02	1,5	20,8	4,9	1,5	2,4	2,3	1,2	1,1	2,0	2,3	1,3	1,8	1,6	
	9150/R65	03	1,7	2,5	5,7	1,7	2,8	2,7	1,4	1,3	2,4	2,7	1,5	2,1	1,9	
	9150/R66	04	2,8	4,0	9,3	2,8	4,5	4,4	2,2	2,1	3,9	4,3	2,4	3,5	3,1	
	9150/R67	05	4,8	6,8	15,9	4,8	7,7	7,5	3,8	3,7	6,6	7,4	4,1	5,9	5,3	
	9150/R68	06	6,7	9,4	22,1	6,6	10,7	10,5	5,3	5,1	9,2	10,2	5,7	8,2	7,4	
	9150/R69	07	10,5	14,9	34,9	10,5	16,8	16,5	8,4	8,0	14,6	16,2	9,0	13,0	11,7	
	9150/R78	08	12,7	18,0	42,0	12,6	20,3	19,9	10,1	9,6	17,5	19,0	10,8	15,6	14,1	
	9150/R79	09	14,1	19,9	46,5	14,0	22,5	22,1	11,2	10,7	19,4	21,6	12,0	17,3	15,6	

(1)  
 Le potenzialità nominali sono riferite a:  
 - Temperatura d'evaporazione T<sub>evap</sub> = + 5 °C  
 - Temperatura di condensazione T<sub>cond</sub> = + 32 °C  
 - Temperatura del liquido all'ingresso della valvola T<sub>liq</sub> = + 28 °C

(1)  
 Rated capacities are based on:  
 - Evaporating temperature T<sub>evap</sub> = + 5 °C  
 - Condensing temperature T<sub>cond</sub> = + 32 °C  
 - Refrigerant liquid temperature ahead of valve T<sub>liq</sub> = + 28 °C

(1)  
 Les capacités nominales se basent sur :  
 - Température d'évaporation T<sub>evap</sub> = +5 °C  
 - Température de condensation T<sub>cond</sub> = +32 °C  
 - Température du liquide frigorigène en amont du détendeur T<sub>liq</sub> = +28 °C

(1)  
 Nennleistungen basieren auf:  
 - Verdampfungstemperatur T<sub>verd</sub> = +5 °C  
 - Kondensationstemperatur T<sub>cond</sub> = +32 °C  
 - Temperatur des flüssigen Kältemittels vor dem Ventil T<sub>flü</sub> = +28 °C

**VALVOLE D'ESPANSIONE A SOLENOIDE CON ORIFIZIO INTERCAMBIABILE PER BASSISSIMA TEMPERATURA**  
**SOLENOID EXPANSION VALVES WITH INTERCHANGEABLE ORIFICE FOR VERY LOW TEMPERATURE**  
**DÉTENDEURS À COMMANDE ÉLECTRIQUES AVEC ENSEMBLE ORICE INTERCHANGEABLE POUR LES TRÈS BASSES TEMPÉRATURES**  
**ELEKTRISCHE EXPANSIONSVENTILE MIT AUSTAUSCHBAREM DUESENEINSATZ BEI SEHR NIEDRIGEN TEMPERATUREN**

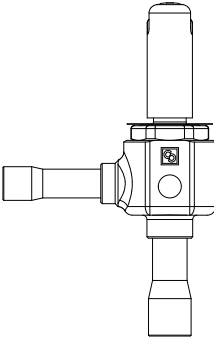

Disegno Drawing Dessin Zeichnung	N° catalogo Part number N° Catalogue Katalog Nr	Tipo orificio Orifice type Type d'orifice Düseneinsatz Typ	Attacchi Connections Raccords Anschlüsse				Kv [m³/h]	Potenzialità nominali Rated capacity Capacités nominales Nennleistungen R23 (1) [kW]	PS [bar]	TS [°C]		Confezione n° pz Package pcs. Emballage Verpackung
			In		Out					Min	Max	
			Ø [in.]	Ø [mm]	Ø [in.]	Ø [mm]						
	2028R/3S01	01	3/8"	-	1/2"	-	0,010	1,5	45	-80	+60	17
	2028R/M10S01		-	10	-	12						
	2028R/3S02	02	3/8"	-	1/2"	-	0,017	3,0				
	2028R/M10S02		-	10	-	12						
	2028R/3S03	03	3/8"	-	1/2"	-	0,023	3,5				
	2028R/M10S03		-	10	-	12						
	2028R/3S04	04	3/8"	-	1/2"	-	0,043	5,7				
	2028R/M10S04		-	10	-	12						
	2028R/3S05	05	3/8"	-	1/2"	-	0,065	9,8				
	2028R/M10S05		-	10	-	12						
	2028R/3S06	06	3/8"	-	1/2"	-	0,113	13,5				
	2028R/M10S06		-	10	-	12						
	2028R/4S07	07	1/2"	-	5/8"	-	0,200	21,4				
	2028R/M12S07		-	12	-	16						
	2028R/4S08	08	1/2"	-	5/8"	-	0,230	25,8				
	2028R/M12S08		-	12	-	16						
	2028R/4S09	09	1/2"	-	5/8"	-	0,250	28,6				
2028R/M12S09	-		12	-	16							

(1)  
Le potenzialità nominali sono riferite a:  
- Temperatura d'evaporazione T<sub>evap</sub> = - 30 °C  
- Temperatura di condensazione T<sub>cond</sub> = - 4 °C  
- Temperatura del liquido all'ingresso della valvola T<sub>liq</sub> = - 8 °C

(1)  
Rated capacities are based on:  
- Evaporating temperature T<sub>evap</sub> = - 30 °C  
- Condensing temperature T<sub>cond</sub> = - 4 °C  
- Refrigerant liquid temperature ahead of valve T<sub>liq</sub> = - 8 °C

(1)  
Les capacités nominales se basent sur :  
- Température d'évaporation T<sub>evap</sub> = - 30 °C  
- Température de condensation T<sub>cond</sub> = - 4 °C  
- Température du liquide frigorigène en amont du détendeur T<sub>liq</sub> = - 8 °C

(1)  
Nennleistungen basieren auf:  
- Verdampfungstemperatur T<sub>verd</sub> = - 30 °C  
- Kondensationstemperatur T<sub>kond</sub> = - 4 °C  
- Temperatur des flüssigen Kältemittels vor dem Ventil T<sub>flü</sub> = - 8 °C

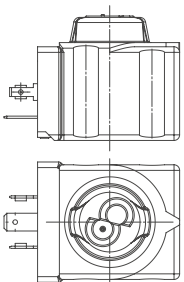
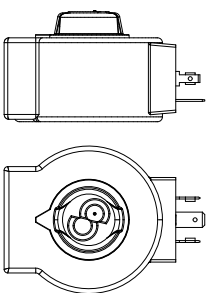
Disegno Drawing Dessin Zeichnung	Tipo Bobina Coil Type Type bobine Spulentyp	N° catalogo Part number N° catalogue Katalog Nr.	Tensione Voltage Tension Spannung [V]	Frequenza Frequency Fréquence Frequenz [Hz]	Potenza Power Puissance Leistung [W]	Connettori Connections Raccordeme Anschlüsse		Confezione n° pz Package pcs Emballage Verpackung
						Grado di protezione Degree of protection Degré de protection Schutz - Klasse		
						IP 65	IP 68	
	HF4	NEW 9360/RA2	24	50/60	8	9150/R02 9900/X66	9155/R01 9155/R02	45
		NEW 9360/RA4	110/120					
		NEW 9360/RA6	220/230					
		NEW 9360/RA7	240					
		NEW 9360/RD1	12 D.C.	-	17			
		NEW 9360/RD2	24 D.C.		15,5			
	HF3	9320/RA6	220/230	50/60	12	9150/R02 9900/X66	-	18
		9320/RD1	12 D.C.	-	20			
		9320/RD2	24 D.C.	-	20			

Bobine 9160/... in esaurimento scorte

Coils 9160/.. running out of stock

Bobines 9160/... en épuisement du stock

Spulen 9160/.. bis zum Ende der Vorräte erhältlich

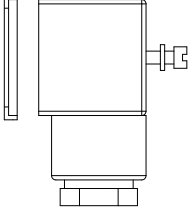
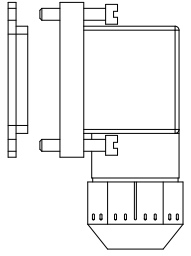
Disegno Drawing Dessin Zeichnung	N° catalogo Part number N° catalogue Katalog Nr.	Grado di protezione Degree of protection Degré de protection Schutz - klasse	Lunghezza cavo Cable length Longueur du câble Kabellänge [m]	Confezione n° pz Package pcs Emballage Verpackung
	9150/R02	IP 65	-	240
	9900/X66		1	100
	9155/R01	IP 65 / IP 68	-	120
	9155/R02		1	1

SISTEMA "SMART CONNECTOR"  
"SMART CONNECTOR" SYSTEM  
SYSTÈME "SMART CONNECTOR"  
"SMART CONNECTOR" SYSTEM

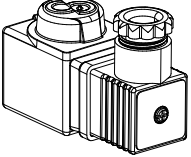
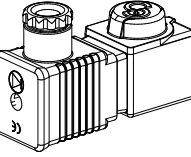
Disegno Drawing Dessin Zeichnung	N° catalogo Part number N° catalogue Katalog Nr.	Tensione Voltage Tension Spannung [V]	Frequenza Frequency Fréquence Frequenz [Hz]	T boost [msec]	Potenza Power Puissance Leistung		Confezione n° pz Package pcs Emballage Verpackung
					esercizio working travail Arbeit [W]	avvio start début Anfang [W]	
	9910/RD1	12 D.C.	-	130	3	50	12
	9910/RD2	24 D.C.	-	130	5	50	12
	9910/RA2	24	50/60	200	7	50	12
	9910/RA6	220	50/60	200	7	50	12
	9910/RA7	240	50/60	200	7	50	12

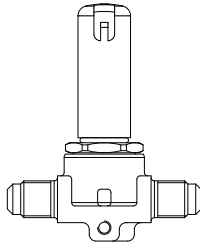
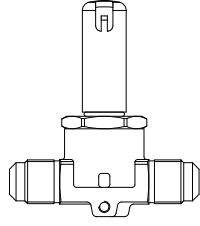
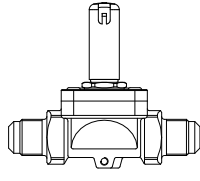
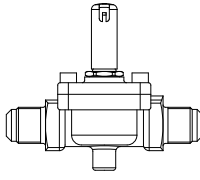
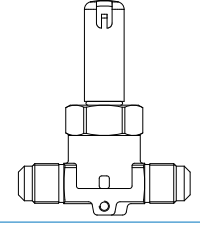
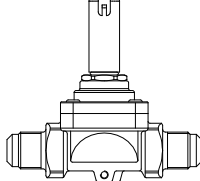
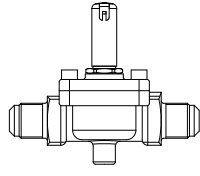

**VALVOLE SOLENOIDI N.C. ATTACCHI SAE FLARE SENZA BOBINA**  
**N.C. SOLENOID VALVES SAE FLARE CONNECTIONS WITHOUT COILS**  
**VANNES ELECTROMAGNETIQUES N.F. SAE FLARE RACCORDS SANS BOBINE**  
**N.G. MAGNETVENTILE MIT BÖRDELANSCHLUSS OHNE SPULE**

Principio di funzionamento Operating principle Principe de fonctionnement Funtionsprinzip	Disegno Drawing Dessin Zeichnung	N° Catalogo Part Number N° Catalogue Katalog Nr	Tipo Bobina Coil Type Type bobine Spulentyp (1)	Attacchi SAE Flare Connections SAE Flare Raccords SAE Flare Anschlüsse SAE Flare	Kv [m³/h]	PS [bar]	TS [°C]		Confezione n° pz Package pcs Emballage Verpackung
							Min	Max	
Azione diretta Direct acting Action directe Direkte Aktion		1020/2S	HF2 HF3 HF4 HM2 HM3 HM4 CM2	1/4"	0,175	45	-35	+110	18
		1020/3S		3/8"	0,23				
Servocomando a membrana Diaphragm pilot operated Servocommande à membrane Membranantrieb		1064/3S	HF2 HF3 HF4 HM2 HM3 HM4 CM2	3/8"	0,8	45	-35	+105	18
		1064/4S		1/2"					
		1070/4S		1/2"	2,2	45	-35	+105	24
		1070/5S		5/8"	2,61				
		1090/5S		5/8"	3,8	45	-35	+105	14
		1090/6S		3/4"	4,8				
Servocomando a pistone Piston pilot operated Servocommande à piston Kolbenantrieb		1034/3S	HF2 HF3 HF4 HM2 HM3 HM4 CM2	3/8"	1,0	45	-35	+110	18
		1034/4S		1/2"					
		1040/4S		1/2"	2,4	45	-35	+110	24
		1040/5S		5/8"	3,0				
		1050/5S		5/8"	3,8	45	-35	+110	14
		1050/6S		3/4"	4,8				

(1)  
bobine che possono essere montate sulle  
valvole

(1)  
coils that can be mounted on the valves

(1)  
bobines qui peuvent être montées sur les  
vannes

(1)  
Spulen, die an den Ventilen montiert werden  
können

**VALVOLE SOLENOIDI N.C. ATTACCHI SAE FLARE CON BOBINE 220/230 VAC (A6)**  
**N.C. SOLENOID VALVES SAE FLARE CONNECTIONS WITH COILS 220/230 VAC (A6)**  
**ELECTROVANNES N.F. SAE FLARE RACCORDS AVEC BOBINE 220/230 VAC (A6)**  
**N.G. MAGNETVENTILE MIT BÖRDELANSCHLUSS UND SPULE 220/230 VAC (A6)**

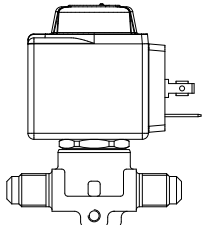
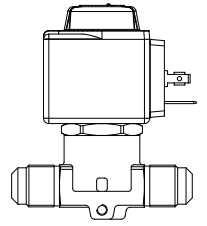
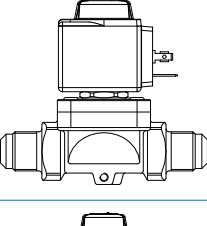
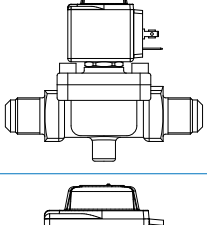
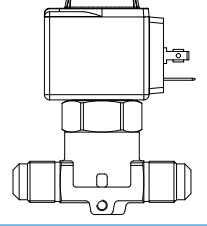
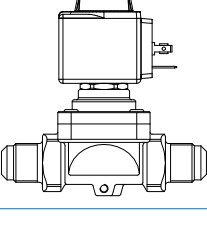
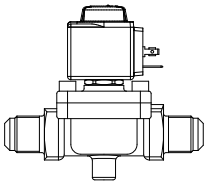
Principio di funzionamento Operating principle Principe de fonctionnement Funtionsprinzip	Disegno Drawing Dessin Zeichnung	N° Catalogo Part Number N° Catalogue Katalog Nr	Tipo Bobina Coil Type Type bobine Spulentyp (1)	Attacchi SAE Flare Connections SAE Flare Raccords SAE Flare Anschlüsse SAE Flare	Kv [m³/h]	PS [bar]	TS [°C]		Confezione n° pz Package pcs Emballage Verpackung
							Min	Max	
Azione diretta Direct acting Action directe Direkte Aktion		1020/2A6	HF2	1/4"	0,175	45	-35	+110	18
		1020/3A6		3/8"	0,23				
Servocomando a membrana Diaphragm pilot operated Servocommande à membrane Membranantrieb		1064/3A6	HF2	3/8"	0,80	45	-35	+105	18
		1064/4A6		1/2"					
		1070/4A6		1/2"	2,20	45	-35	+105	24
		1070/5A6		5/8"	2,61				
		1090/5A6		5/8"	3,80	45	-35	+105	14
		1090/6A6		3/4"	4,8				
Servocomando a pistone Piston pilot operated Servocommande à piston Kolbenantrieb		1034/3A6	HF2	3/8"	1,0	45	-35	+110	18
		1034/4A6		1/2"					
		1040/4A6		1/2"	2,4	45	-35	+110	24
		1040/5A6		5/8"	3,0				
		1050/5A6		5/8"	3,8	45	-35	+110	14
		1050/6A6		3/4"	4,8				

(1)  
bobine montate sulle valvole

(1)  
coils mounted on the valves

(1)  
Bobines montées sur des vannes

(1)  
An den Ventilen montierte Spulen

**VALVOLE SOLENOIDI N.C. ATTACCHI ODS SENZA BOBINA**  
**N.C. SOLENOID VALVES ODS CONNECTIONS WITHOUT COILS**  
**VANNES ELECTROMAGNETIQUES N.F. ODS RACCORDS SANS BOBINE**  
**N.G. MAGNETVENTILE ODS ANSCHLÜSSE OHNE SPULE**

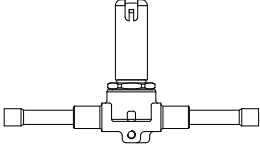
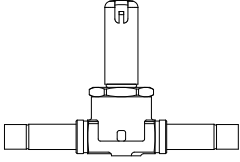
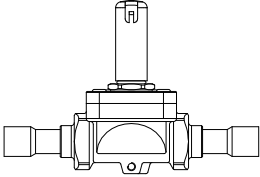
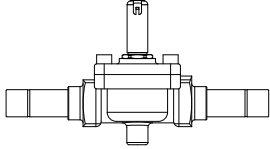
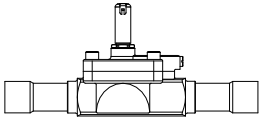
Principio di funzionamento Operating principle Principe de fonctionnement Funtionsprinzip	Disegno Drawing Dessin Zeichnung	N° Catalogo Part Number N° Catalogue Katalog Nr	Tipo Bobina Coil Type Type bobine Spulentyp (1)	Attacchi ODS Ø Connections ODS Ø Raccords ODS Ø Anschlüsse ODS Ø		Kv [m³/h]	PS [bar]	TS [°C]		Confezione n° pz Package Pcs. Emballage Verpackung
				[in.]	[mm]			Min	Max	
Azione diretta Direct acting Action directe Direkte Aktion		1028/2S	HF2 HF3 HF4 HM2 HM3 HM4 CM2	1/4"	-	0,15	45	-35	+110	24
		1028/2S.E		1/4"	-					
		1028/3S		3/8"	-	0,23				
		1028/M10S		-	10					
Servocomando a membrana Diaphragm pilot operated Servocommande à membrane Membranantrieb		1068/3S	HF2 HF3 HF4 HM2 HM3 HM4 CM2	3/8"	-	0,8	45	-35	+105	24
		1068/M10S		-	10					
		1068/M12S		-	12					
		1068/4S		1/2"	-					
		1078/M12S	HF2 HF3 HF4 HM2 HM3 HM4 CM2	-	12	2,2	45	-35	+105	17
		1078/4S		1/2"	-					
		1078/5S		5/8"	16	2,61				
		1079/7S		7/8"	22					
		1098/5S	HF2 HF3 HF4 HM2 HM3 HM4 CM2	5/8"	16	3,8	45	-35	+105	14
		1098/6S		3/4"	-					
		1098/7S		7/8"	22	5,7				
		1099/9S		1.1/8"	-					
		1078/9S	HF2 HF3 HF4 HM2 HM3 HM4 CM2	1.1/8"	-	10	45	-35	+105	1
		1079/11S		1.3/8"	35					

(1) bobine che possono essere montate sulle valvole

(1) coils that can be mounted on the valves

(1) bobines qui peuvent être montées sur les vannes

(1) Spulen, die an den Ventilen montiert werden können

**VALVOLE SOLENOIDI N.C. ATTACCHI ODS SENZA BOBINA**  
**N.C. SOLENOID VALVES ODS CONNECTIONS WITHOUT COILS**  
**VANNES ELECTROMAGNETIQUES N.F. ODS RACCORDS SANS BOBINE**  
**N.G. MAGNETVENTILE ODS ANSCHLÜSSE OHNE SPULE**

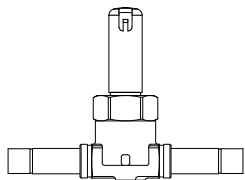
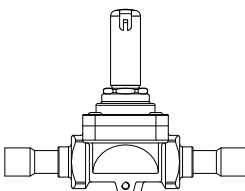
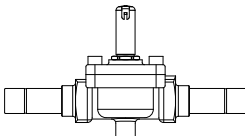
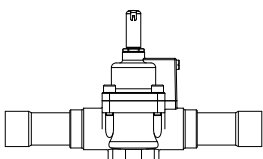
Principio di funzionamento Operating principle Principe de fonctionnement Funtionsprinzip	Disegno Drawing Dessin Zeichnung	N° Catalogo Part Number N° Catalogue Katalog Nr	Tipo Bobina Coil Type Type bobine Spulentyp (1)	Attacchi ODS Ø Connections ODS Ø Raccords ODS Ø Anschlüsse ODS Ø		Kv [m³/h]	PS [bar]	TS [°C]		Confezione n° pz Package Pcs. Emballage Verpackung
				[in.]	[mm]			Min	Max	
Servocomando a pistone Piston pilot operated Servocommande à piston Kolbenantrieb		1038/3S	HF2 HF3 HF4 HM2 HM3 HM4 CM2	3/8"	-	1,00	45	-35	+110	24
		1038/M10S		-	10					
		1038/M12S		-	12					
		1038/4S		1/2"	-					
		1048/M12S		-	12	2,4	45	-35	+110	14
		1048/4S		1/2"	-					
		1048/5S		5/8"	16	3,0				
		1049/7S		7/8"	22					
		1058/5S		5/8"	16	3,8	45	-35	+110	14
		1058/6S		3/4"	-	4,8				
		1058/7S		7/8"	22	5,7				
		1059/9S		1.1/8"	-					
		1098/9S		1.1/8"	-	10	45	-35	+110	1
		1099/11S		1.3/8"	35	16				
		1078/11S		1.3/8"	35					
		1079/13S		1.5/8"	-	25				
		1079/M42S		-	42					
		1078/13S		1.5/8"	-					
		1078/M42S		-	42					
		1079/17S		2.1/8"	54					

(1) bobine che possono essere montate sulle valvole

(1) coils that can be mounted on the valves

(1) bobines qui peuvent être montées sur les vannes

(1) Spulen, die an den Ventilen montiert werden können

**VALVOLE SOLENOIDI N.C. ATTACCHI ODS CON BOBINA 220/230 VAC (A6)**  
**N.C. SOLENOID VALVES ODS CONNECTIONS WITH COILS 220/230 VAC (A6)**  
**VANNES ELECTROMAGNETIQUES N.F. ODS RACCORDS AVEC BOBINE 220/230 VAC (A6)**  
**N.G. MAGNETVENTILE ODS ANSCHLÜSSE MIT SPULE 220/230 VAC (A6)**

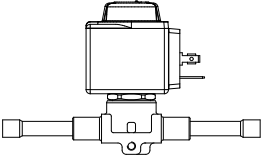
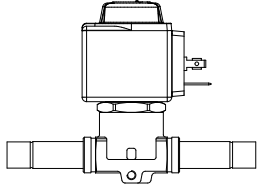
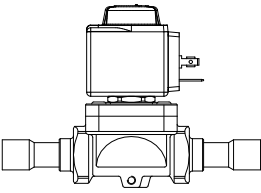
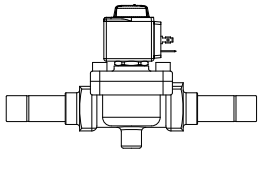
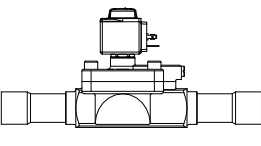
Principio di funzionamento Operating principle Principe de fonctionnement Funtionsprinzip	Disegno Drawing Dessin Zeichnung	N° Catalogo Part Number N° Catalogue Katalog Nr	Tipo Bobina Coil Type Type bobine Spulentyp (1)	Attacchi ODS Ø Connections ODS Ø Raccords ODS Ø Anschlüsse ODS Ø		Kv [m³/h]	PS [bar]	TS [°C]		Confezione n° pz Package pcs Emballage Verpackung
				[in.]	[mm]			Min	Max	
Azione diretta Direct acting Action directe Direkte Aktion		1028/2A6	HF2	1/4"	-	0,15	45	-35	+110	24
		1028/2A6.E		1/4"	-	0,23				
		1028/3A6		3/8"	-					
		1028/M10A6		-	10					
Servocomando a membrana Diaphragm pilot operated Servocommande à membrane Membranantrieb		1068/3A6	HF2	3/8"	-	0,8	45	-35	+105	24
		1068/M10A6		-	10					
		1068/M12A6		-	12					
		1068/4A6		1/2"	-					
		1078/M12A6	HF2	-	12	2,2	45	-35	+105	17
		1078/4A6		1/2"	-					
		1078/5A6		5/8"	16	2,61				
		1079/7A6		7/8"	22					
		1098/5A6	HF2	5/8"	16	3,8	45	-35	+105	14
		1098/6A6		3/4"	-					
		1098/7A6		7/8"	22	5,7				
		1099/9A6		1.1/8"	-					
		1078/9A6	HF2	1.1/8"	-	10	45	-35	+105	1
		1079/11A6		1.3/8"	35					

(1) bobine montate sulle valvole

(1) coils mounted on the valves

(1) Bobines montées sur des vannes

(1) An den Ventilen montierte Spulen

**VALVOLE SOLENOIDI N.C. ATTACCHI ODS CON BOBINA 220/230 VAC (A6)**  
**N.C. SOLENOID VALVES ODS CONNECTIONS WITH COILS 220/230 VAC (A6)**  
**VANNES ELECTROMAGNETIQUES N.F. ODS RACCORDS AVEC BOBINE 220/230 VAC (A6)**  
**N.G. MAGNETVENTILE ODS ANSCHLÜSSE MIT SPULE 220/230 VAC (A6)**

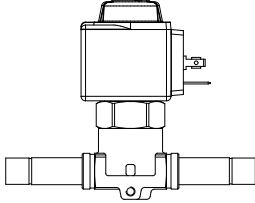
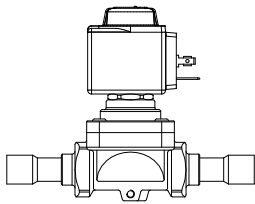
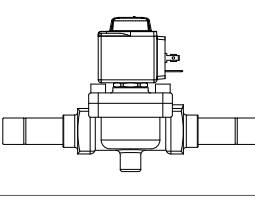
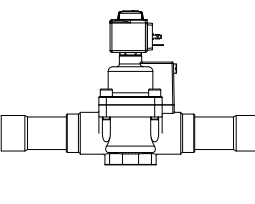
Principio di funzionamento Operating principle Principe de fonctionnement Funtionsprinzip	Disegno Drawing Dessin Zeichnung	N° Catalogo Part Number N° Catalogue Katalog Nr	Tipo Bobina Coil Type Type bobine Spulentyp (1)	Attacchi ODS Ø Connections ODS Ø Raccords ODS Ø Anschlüsse ODS Ø		Kv [m³/h]	PS [bar]	TS [°C]		Confezione n° pz Package pcs Emballage Verpackung
				[in.]	[mm]			Min	Max	
Servocomando a pistone Piston pilot operated Servocommande à piston Kolbenantrieb		1038/3A6	HF2	3/8"	-	1,0	45	-35	+110	24
		1038/M10A6		-	10					
		1038/M12A6		-	12					
		1038/4A6		1/2"	-					
		1048/M12A6		-	12	2,4	45	-35	+110	14
		1048/4A6		1/2"	-					
		1048/5A6		5/8"	16	3,0				
		1049/7A6		7/8"	22					
		1058/5A6		5/8"	16	3,8	45	-35	+110	14
		1058/6A6		3/4"	-	4,8				
		1058/7A6		7/8"	22	5,7				
		1059/9A6		1.1/8"	-					
		1098/9A6		1.1/8"	-	10	45	-35	+110	1
		1099/11A6		1.3/8"	35					
		1078/11A6		1.3/8"	35					
		1079/13A6		1.5/8"	-	16				
		1079/M42A6		-	42					
		1078/13A6		1.5/8"	-	25				
		1078/M42A6		-	42					
		1079/17A6		2.1/8"	54					

(1) bobine montate sulle valvole

(1) coils mounted on the valves

(1) Bobines montées sur des vannes

(1) An den Ventilen montierte Spulen

**VALVOLE SOLENOIDI N.A. ATTACCHI SAE FLARE SENZA BOBINA**  
**N.O. SOLENOID VALVES SAE FLARE CONNECTIONS WITHOUT COILS**  
**VANNES ELECTROMAGNETIQUES N.O. SAE FLARE RACCORDS SANS BOBINE**  
**N.O. MAGNETVENTILE MIT BÖRDELANSCHLUSS OHNE SPULE**

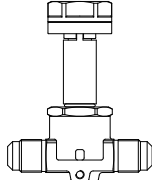
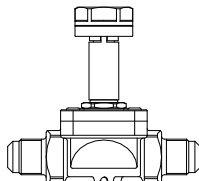
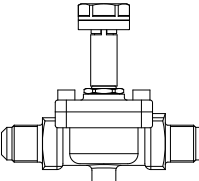
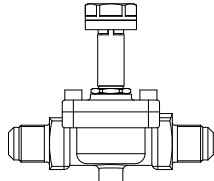
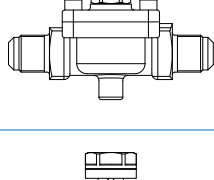
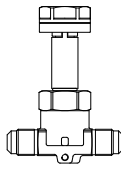
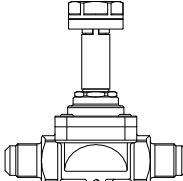
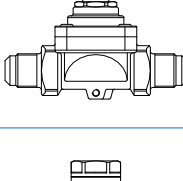
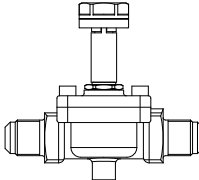
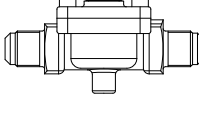
Principio di funzionamento Operating principle Principe de fonctionnement Funktionsprinzip	Disegno Drawing Dessin Zeichnung	N° Catalogo Part Number N° Catalogue Katalog Nr	Tipo Bobina Coil Type Type bobine Spulentyp (1)	Attacchi SAE Flare Connections SAE Flare Raccords SAE Flare Anschlüsse SAE Flare	Kv [m <sup>3</sup> /h]	PS [bar]	TS [°C]		Confezione n° pz Package pcs Emballage Verpackung
							Min	Max	
Servocomando a membrana Diaphragm pilot operated Servocommande à membrane Membranantrieb		1164/3S	HM3	3/8"	0,8	45	-35	+105	24
		1170/4S		1/2"	2,2				
		1170/5S		5/8"	2,61	45	-35	+105	24
		1190/5S		5/8"	3,8	45	-35	+105	14
		1190/6S		3/4"	4,8				
	Servocomando a pistone Piston pilot operated Servocommande à piston Kolbenantrieb			1134/3S	HM3	3/8"	1,0	45	-35
		1140/4S	1/2"	2,4					
		1140/5S	5/8"	3,0		45	-35	+110	24
		1150/5S	5/8"	3,8		45	-35	+110	14
		1150/6S	3/4"	4,8					

Le valvole NA sono state progettate per il funzionamento con bobine in corrente continua.  
 Per applicazioni con alimentazione a 220/230 V AC utilizzare la bobina 9120/RD6 con il connettore 9150/R45

(1)  
 bobine che possono essere montate sulle valvole

The N.O. valves have been designed to work only with direct current coil.  
 To use them with an alternate current supply it's necessary to mate the N.O. valve with the 9120/RD6 coil and the connector 9150/R45

(1)  
 coils that can be mounted on the valves

Les vannes N.O. ont été conçues pour le fonctionnement avec des bobines en courant continu uniquement.  
 Pour les applications avec alimentation en courant alternatif, il faut coupler la vanne N.O. avec la bobine 9120/RD6 et le connecteur 9150/R45.

(1)  
 bobines qui peuvent être montées sur les vannes

Die N.O. Ventile sind ausschließlich für den Betrieb mit Gleichstromspulen vorgesehen.  
 Bei Verwendung mit Wechselstromspeisung ist das N.O. Ventile mit Spule 9120/RD6 und Verbinder 9150/R45

(1)  
 Spulen, die an den Ventilen montiert werden können

**VALVOLE SOLENOIDI N.A. ATTACCHI ODS SENZA BOBINA**  
**N.O. SOLENOID VALVES ODS CONNECTIONS WITHOUT COILS**  
**VANNES ELECTROMAGNETIQUES N.O. ODS RACCORDS SANS BOBINE**  
**N.O. MAGNETVENTILE ODS ANSCHLÜSSE OHNE SPULE**

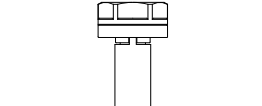
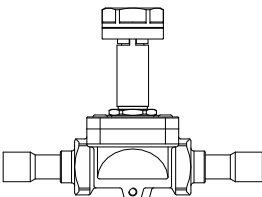
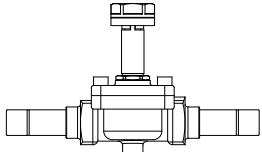
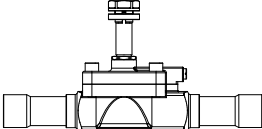
Principio di funzionamento Operating principle Principe de fonctionnement Funtionsprinzip	Disegno Drawing Dessin Zeichnung	N° Catalogo Part Number N° Catalogue Katalog Nr	Tipo Bobina Coil Type Type bobine Spulentyp (1)	Attacchi ODS Ø Connections ODS Ø Raccords ODS Ø Anschlüsse ODS Ø		Kv [m³/h]	PS [bar]	TS [°C]		Confezione n° pz Package pcs Emballage Verpackung
				[in.]	[mm]			Min	Max	
Servocomando a membrana Diaphragm pilot operated Servocommande à membrane Membranantrieb		1168/3S	HM3	3/8"	-	0,8	45	-35	+105	24
		1168/M10S		-	10					
		1178/M12S		-	12	2,2	45	-35	+105	14
		1178/4S		1/2"	-					
		1178/5S		5/8"	16					
		1198/5S		5/8"	16	3,8	45	-35	+105	14
		1198/6S		3/4"	-					
		1198/7S		7/8"	22					
		1178/9S		1.1/8"	-	10	45	-35	+105	1

Le valvole NA sono state progettate per il funzionamento con bobine in corrente continua.  
 Per applicazioni con alimentazione a 220/230 V AC utilizzare la bobina 9120/RD6 con il connettore 9150/R45

(1)  
 bobine che possono essere montate sulle valvole

The N.O. valves have been designed to work only with direct current coil.  
 To use them with an alternate current supply it's necessary to mate the N.O. valve with the 9120/RD6 coil and the connector 9150/R45

(1)  
 coils that can be mounted on the valves

Les vannes N.O. ont été conçues pour le fonctionnement avec des bobines en courant continu uniquement.  
 Pour les applications avec alimentation en courant alternatif, il faut coupler la vanne N.O. avec la bobine 9120/RD6 et le connecteur 9150/R45.







(1)  
 bobines qui peuvent être montées sur les vannes

Die N.O. Ventile sind ausschließlich für den Betrieb mit Gleichstromspulen vorgesehen.  
 Bei Verwendung mit Wechselstromspeisung ist das N.O. Ventile mit Spule 9120/RD6 und Verbinder 9150/R45

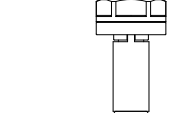
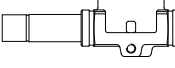
(1)  
 Spulen, die an den Ventilen montiert werden können

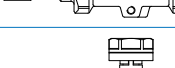
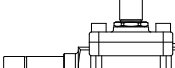
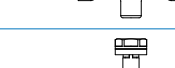

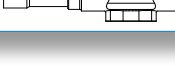
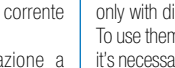
**VALVOLE SOLENOIDI N.A. ATTACCHI ODS SENZA BOBINA**  
**N.O. SOLENOID VALVES ODS CONNECTIONS WITHOUT COILS**  
**VANNES ELECTROMAGNETIQUES N.O. ODS RACCORDS SANS BOBINE**  
**N.O. MAGNETVENTILE ODS ANSCHLÜSSE OHNE SPULE**

Principio di funzionamento Operating principle Principe de fonctionnement Funktionsprinzip	Disegno Drawing Dessin Zeichnung	N° Catalogo Part Number N° Catalogue Katalog Nr	Tipo Bobina Coil Type Type bobine Spulentyp (1)	Attacchi ODS Ø Connections ODS Ø Raccords ODS Ø Anschlüsse ODS Ø		Kv [m³/h]	PS [bar]	TS [°C]		Confezione n° pz Package pcs Emballage Verpackung
				[in.]	[mm]			Min	Max	
Servocomando a pistone Piston pilot operated Servocommandeà piston Kolbenantrieb		1138/3S	HM3	3/8"	-	1,0	45	-35	+110	24
		1138/M10S		-	10					
		1148/M12S		-	12	2,4	45	-35	+110	14
		1148/4S		1/2"	-					
		1148/5S		5/8"	16	3,0	45	-35	+110	14
		1158/5S		5/8"	16					
		1158/6S		3/4"	-	4,8	45	-35	+110	14
		1158/7S		7/8"	22					
		1198/9S		1.1/8"	-	10	45	-35	+110	1
		1178/11S		1.3/8"	35					
		1178/13S		1.5/8"	-	25	45	-35	+110	1
		1178/M42S		-	42					

Le valvole NA sono state progettate per il funzionamento con bobine in corrente continua.  
 Per applicazioni con alimentazione a 220/230 V AC utilizzare la bobina 9120/RD6 con il connettore 9150/R45

(1)  
 bobine che possono essere montate sulle valvole

The N.O. valves have been designed to work only with direct current coil.  
 To use them with an alternate current supply it's necessary to mate the N.O. valve with the 9120/RD6 coil and the connector 9150/R45

(1)  
 coils that can be mounted on the valves

Les vannes N.O. ont été conçues pour le fonctionnement avec des bobines en courant continu uniquement.  
 Pour les applications avec alimentation en courant alternatif, il faut coupler la vanne N.O. avec la bobine 9120/RD6 et le connecteur 9150/R45.

(1)  
 bobines qui peuvent être montées sur les vannes

Die N.O. Ventile sind ausschließlich für den Betrieb mit Gleichstromspulen vorgesehen.  
 Bei Verwendung mit Wechselstromspeisung ist das N.O. Ventile mit Spule 9120/RD6 und Verbinder 9150/R45

(1)  
 Spulen, die an den Ventilen montiert werden können

**BOBINE  
COILS  
BOBINES  
SPULEN**

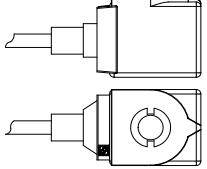
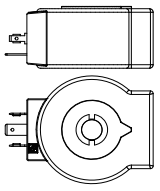
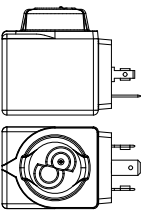
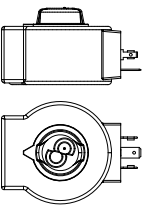
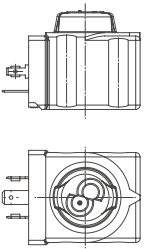
Disegno Drawing Dessin Zeichnung	Tipo Bobina Coil Type Type bobine Spulentyp	N° catalogo Part number N° Catalogue Katalog Nr	Tensione Voltage Tension Spannung [V]	Frequenza Frequency Fréquence Frequenz [Hz]	Potenza Power Puissance Leistung [W]	Lunghezza cavo Cable length Longueur du câble Kabellänge [m]	Confezione n° pz Package pcs Emballage Verpackung
	CM2 (1)	9110/RA2	24	50/60	8	1	8
		9110/RA4	110				
		9110/RA6	220/230				
		9110/RA7	240				
	HM3	9120/RD1	12 D.C.	-	20	-	45
		9120/RD2	24 D.C.				
		9120/RD3	27 D.C.				
		9120/RD4	48 D.C.		22		
		9120/RD6 (2)	220 RAC		18		
	HF2	9300/RA2	24	50/60	8	-	30
		9300/RA4	110				
		9300/RA6	220/230				
		9300/RA7	240				
		9300/RA8	380				
	HF3	9320/RA6	220/230	50/60	12	-	18
		9320/RD1	12 D.C.				
		9320/RD2	24 D.C.				
		9320/RD3	27 D.C.		20		
		9320/RD4	48 D.C.				
	HF4	<b>NEW</b> 9360/RA2	24	50/60	8	-	45
		<b>NEW</b> 9360/RA4	110/120				
		<b>NEW</b> 9360/RA6	220/230				
		<b>NEW</b> 9360/RA7	240				
		<b>NEW</b> 9360/RD1	12 D.C.	-	17		
		<b>NEW</b> 9360/RD2	24 D.C.		15,5		

(1)  
bobina dotata di ricambio G9150/R97

(2)  
Utilizzare esclusivamente con connettore  
raddrizzatore 9150/R45

(1)  
coil with spare part G9150/R97

(2)  
Use only with 9150/R45 connector /  
rectifier

(1)  
Bobine avec remplacement G9150/R97

(2)  
Utiliser exclusivement en association avec le  
connecteur/redresseur 9150/R45

(1)  
Spule mit Ersatz G9150/R97 ausgestattet

(2)  
Bitte nur mit verbinder/gleichrichter 9150/  
R45 benutzen

**CONNETTORI  
CONNECTORS  
CONNECTEURS  
STECKER**

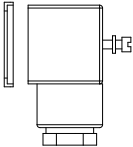
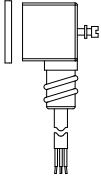
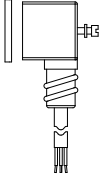
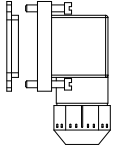
Disegno Drawing Dessin Zeichnung	N° catalogo Part number N° catalogue Katalog Nr.	Grado di protezione Degree of protection Degré de protection Schutz - Klasse	Lunghezza cavo Cable length Longueur du câble Kabellänge [m]	Confezione n° pz Package pcs Emballage Verpackung
	9150/R02	IP 65	-	240
	9150/R45 (1)			1
	9150/R90 (1)	IP 65	2	1
	9900/X66	IP 65	1	50
	9900/X84		1,5	50
	9900/X73		2	30
	9900/X55		3	25
	9900/X54		5	25
	9900/X93		10	15
	9901/X41		15	15
	9155/R01	IP 65 / IP 68	-	120
	9155/R02		1	1

(1)  
Connettore/Raddrizzatore: tensione  
d'alimentazione 220/230V AC

(1)  
Connector/Rectifier: supply voltage  
220/230V AC

(1)  
Connecteur/Redresseur: tension  
d'alimentation 220/230V AC

(1)  
Verbinder/Gleichrichter: Speisespannung  
220/230V AC

**MAGNETE PERMANENTE  
PERMANENT MAGNET  
OUTIL MAGNETIQUE  
DÄERMAGNET**

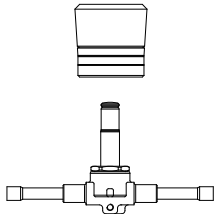
Disegno Drawing Dessin Zeichnung	N° catalogo Part number N° catalogue Katalog Nr.	Confezione n° pz Package pcs Emballage Verpackung
	9900/X91	1

**VALVOLE DI SICUREZZA**  
**SAFETY VALVES**  
**SOUPAPES DE SURETE**  
**SICHERHEITSENTILE**

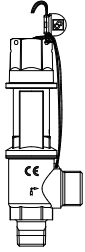
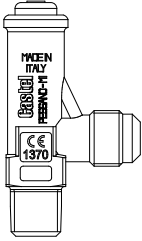
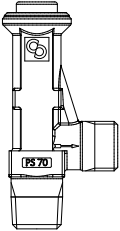
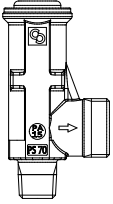
Disegno Drawing Dessin Zeichnung	N° Catalogo Part Number N° Catalogue Katalog Nr	Attacchi Connections Raccords Anschlüsse		Sezione orifizio Orifice section Section orifice Öffnungs- querschnitt [mm <sup>2</sup> ]	Coefficiente di scarico Kd Discharge coefficient Kd Coefficient d'écoulement Kd Ausströmungsfaktor Kd	Campo taratura Set pressure range Champ de tarage Einstellbereich [bar]	PS [bar]	TS [°C]		Confezione n° pz Package pcs Emballage Verpackung
		IN	OUT					Min	Max	
	3030/88C	1" NPT	1.1/4" G	298	0,83	8 → 50	55	-50	+150	8
	3030/66C	3/4" NPT	3/4" G	113	0,9					15
	3030/44C	1/2" NPT	3/4" G	113	0,9					15
	3030/44G (1)	1/2" G	3/4" G	113	0,9	8 → 50				15
	3060/46C	1/2" NPT	3/4" G	78,5	0,93	9 → 50	55	-50	+120	45
	3060/36C	3/8" NPT	3/4" G	78,5	0,92					45
	3060/45C	1/2" NPT	5/8" SAE	70,9	0,45					45
	3060/34C	3/8" NPT	1/2" SAE	38,5	0,69					45
	3060/33C	3/8" NPT	3/8" SAE	38,5	0,63					45
	3060/24C	1/4" NPT	1/2" SAE	38,5	0,69					45
	3060/23C	1/4" NPT	3/8" SAE	38,5	0,63					45
	3061/2C	1/4" NPT	3/8" G	44,2	0,89	11 → 60	70	-50	+150	18
	3061/3C	3/8" NPT	1/2" G							18
	3061/4C	1/2" NPT	1/2" G							18
	3065/4C	1/2" NPT	1" G	132,7	0,87	11 → 60	70	-50	+150	24
	3065/6C	3/4" NPT	1" G							24

(1)  
Prodotto a richiesta.

(1)  
Product on request.

(1)  
Produit sur demande.

(1)  
Produkt auf Anfrage.

**DISPOSITIVI DI SICUREZZA CON DISCO DI ROTTURA**  
**BURSTING DISCSAFETY DEVICES**  
**DISPOSITIF DE SÉCURITÉ AVEC DISQUE DE RUPTURE**  
**SICHERHEITSVORRICHTUNG MIT BERSTPLATTE**

Disegno Drawing Dessin Zeichnung	N° Catalogo Part Number N° Catalogue Katalog Nr	Attacchi Connections Raccords Anschlüsse			Sezione orifizio Orifice section Section orifice Öffnungs- -querschnitt [mm <sup>2</sup> ]	Pressione di rottura Pb Bursting pressure Pb Pression de rupture Pb Brechdruck Pb	Max pressione d'esercizio Max operating pressure Pression d'exercice max. Max. Betriebsdruck	PS [bar]	TS [°C]		Confezione n° pz Package pcs Emballage Verpackung
		IN maschio male IN IN mâle EINGANG mit Außengewinde	OUT femmina female OUT OUT femelle AUSGANG mit Innengewinde	servizio service service Hilfsanschluss					min	max	
	3070/44C140	1/2" NPT	1/2" NPT	2 x 1/8" NPT	113	14,0	75 % Pb	55	-50	+150	20
	3070/44C150					15,0					
	3070/44C160					16,0					
	3070/44C190					19,0					
	3070/44C210					21,0					
	3070/44C230					23,0					
	3070/44C240					24,0					
	3070/44C248					24,8					
	3070/44C250					25,0					
	3070/44C270					27,0					
	3070/44C275					27,5					
	3070/44C280					28,0					
	3070/44C370					37,0					
	3070/44C440					44,0					
	3070/44C470					47,0					
	3070/44C500					50,0					
3070/44C520	52,0										

**RUBINETTI DI SCAMBIO**  
**CHANGEOVER VALVES**  
**VANNE D'ECHANGE**  
**WECHSELHAHN**

Disegno Drawing Dessin Zeichnung	N° Catalogo Part Number N° Catalogue Katalog Nr	Raccordi forniti Supplied connections Raccords fournis Mitgelieferte Anschlüsse	Attacchi Connections Raccords Anschlüsse		Kv [m <sup>3</sup> /h]	PS [bar]	TS [°C]		Confezione n° pz Package pcs Emballage Verpackung
			IN	OUT			Min	Max	
	3032/33	3039/3	3/8" NPT	3/8" NPT	2,5	80	-40	+120	14
	3032/44	3039/4	1/2" NPT	1/2" NPT	3,3				
	3032/64	-	3/4" NPT	1/2" NPT	9	80	-40	+150	15
	3032/66	-	3/4" NPT	3/4" NPT	9				
	3032/88	-	1" NPT	1" NPT	14,5				1
	3032/108	-	1.1/4" NPT	1" NPT	20				

**COPPIE DI ATTACCHI PER RUBINETTI DI SCAMBIO**  
**COUPLE OF CONNECTIONS FOR CHANGEVER VALVES**  
**COUPLE DE CONNECTIONS POUR VANNE D'ECHANGE**  
**LÖTFITTING-PAR FÜR WECHSELHAHN**

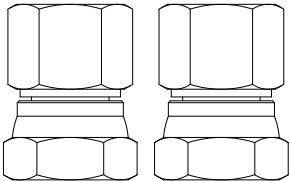
Disegno Drawing Dessin Zeichnung	N° catalogo Part number N° Catalogue Katalog Nr	Attacco Connection Raccord Anschluss	Materiali Materials Matériaux Werkstoffe	Confezione n° pz Package pcs. Emballage Verpackung
	3039/2	1/4" NPT-F	Ferro zincato Zinc plated steel Acier galvanisé Stahl verzinkt	25
	3039/3	3/8" NPT-F		
	3039/4	1/2" NPT-F		
	3039/30T	3/8" NPT-F	acciaio inox/ottone stainless steel/brass inox / laiton	
	3039/40T	1/2" NPT-F	Edelstahl / Messing	

**RUBINETTI DI INTERCETTAZIONE A SFERA**  
**BALL SHUT OFF VALVES**  
**VANNE D'INTERCEPTION A BOISSEAU SPHERIQUE**  
**KUGELABSPERRHAHN**

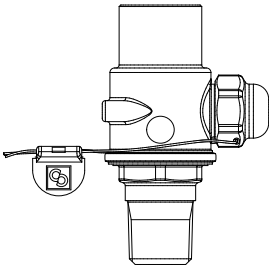
Disegno Drawing Dessin Zeichnung	N° Catalogo Part Number N° Catalogue Katalog Nr	Attacchi Connections Raccords Anschlüsse	Kv [m³/h]	PS [bar]	TS [°C]		Confezione n° pz Package pcs Emballage Verpackung
		NPT			Min	Max	
	3064/22	1/4"	2,5	80	-40	+150	20
	3064/33	3/8"	5				20
	3064/44	1/2"	10				24
	3064/88	1"	20				14

**RACCORDI**  
**UNIONS**  
**RACCORDS**  
**ANSCHLÜSSE**

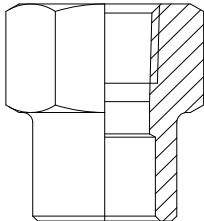
Disegno Drawing Dessin Zeichnung	N° Catalogo Part Number N° Catalogue Katalog Nr	Attacchi Connections Raccords Anschlüsse		PS [bar]	Confezione n° pz Package pcs Emballage Verpackung
		NPT	ODS Ø [mm]		
	3035/2	1/4"	12	150	100
	3035/3	3/8"	18		100
	3035/4	1/2"	22		60
	3035/6	3/4"	28	120	24
	3035/8	1"	35		20
	3035/10	1.1/4"	42		6

**TAPPI FUSIBILI**  
**FUSIBLE PLUGS**  
**BOUCHONS FUSIBLES**  
**SCHMELZVERSCHLÜSSE**

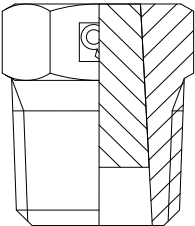
Disegno Drawing Dessin Zeichnung	N° catalogo Part number N° Catalogue Katalog Nr	Attacchi NPT Connections NPT Raccords NPT Anschlüsse NPT	Sezione orifizio Orifice section Section orifice Öffnungs- querschnitt [mm <sup>2</sup> ]	Kd	PS [bar]	Temperatura di fusione Melting point Température de fusion Schmelztemperatur [°C]	Max temperatura d'esercizio Max operating temperature Temperature deservice max Maximale Betriebstemperatur [°C]	Confezione n° pz Package pcs Emballage Verpackung
	3080/1C	1/8"	18,8	0,91	42	79	68	10
	3080/2C	1/4"	25,5					
	3080/3C	3/8"	56,7					
	3080/4C	1/2"	67,9					
	3082/1C	1/8"	18,8	0,91	30	138	127	
	3082/2C	1/4"	25,5					
	3082/3C	3/8"	56,7					
	3082/4C	1/2"	67,9					

**VALVOLE DI RITEGNO ERMETICHE - OMOLOGATE DA UNDERWRITERS LABORATORIES INC.**  
**HERMETIC CHECK VALVES - APPROVED BY UNDERWRITERS LABORATORIES INC.**  
**CLAPETS ANTI-RETOUR HERMÉTIQUES - HOMOLOGUÉS PAR UNDERWRITERS LABORATORIES INC.**  
**HERMETISCHE RÜCKSCHLAGVENTILE - ZUGELASSEN VON UNDERWRITERS LABORATORIES INC.**

Disegno Drawing Dessin Zeichnung	N° catalogo Part number N° catalogue Katalog Nr.	Attacchi Connections Raccords Anschlüsse			Kv [m <sup>3</sup> /h]	Pressione differenziale Differential pressure Pression différentielle Differenzial Druck (1) [bar]	PS [bar]	TS [°C]		Confezione n° pz Package pcs Emballage Verpackung
		SAE Flare	ODS					min	max	
			Ø [in.]	Ø [mm]						

In linea con attacchi SAE FLARE / Straight with SAE FLARE connections / Connexions droites SAE flare / Durchfluss Verbindung SAE Bördel

	3112W/2	1/4"	-	-	0,5	0,04	50 (2)	-40	+150	20
	3112W/3	3/8"	-	-	1,5					
	3112W/4	1/2"	-	-	1,8					
	3112W/5	5/8"	-	-	3,3					
	3112W/6	3/4"	-	-	5					
	3113W/2	1/4"	-	-	0,5					
	3113W/3	3/8"	-	-	1,5					
	3113W/4	1/2"	-	-	1,8					
	3113W/5	5/8"	-	-	3,3					
		3113W/6	3/4"	-	-	5				

In linea con attacchi ODS di rame / Straight with copper ODS connections / Connexions droites ODS cuivre / Durchfluss Verbindung ODS Kupfer

	3132W/2	1/4"	-	-	0,5	0,04	50 (2)	-40	+150	25	
	3132W/3	3/8"	-	-	1,5						
	3132W/M10	-	10	-	1,5						
	3132W/M12	-	12	-	1,8						
	3132W/4	1/2"	-	-	1,8						
	3132W/5	5/8"	16	-	3,3						
		3132W/M18	-	18	-	5	0,3	50 (2)	-40	+150	21
		3132W/6	3/4"	-	-	5					
		3132W/7	7/8"	22	-	5					
		3133W/2	1/4"	-	-	0,5					
		3133W/3	3/8"	-	-	1,5					
		3133W/M10	-	10	-	1,5					
		3133W/M12	-	12	-	1,8					
		3133W/4	1/2"	-	-	1,8					
		3133W/5	5/8"	16	-	3,3					
		3133W/M18	-	18	-	5					
		3133W/6	3/4"	-	-	5					
		3133W/7	7/8"	22	-	5					

(1)  
Minima pressione a cui la valvola è completamente aperta

(2)  
MWP = 600 psi in conformità a omologazione UL

(1)  
Minimum pressure at which the valve is completely open

(2)  
MWP = 600 psi according to UL approval

(1)  
Pression minimale à laquelle la vanne est entièrement ouverte

(2)  
MWP = 600 psi conformément à homologation UL

(1)  
Mindestdruck, bei dem das Ventil vollständig offen ist

(2)  
MWP = 600 psi in Übereinstimmung zur UL-Zulassung



**VALVOLE DI RITEGNO ERMETICHE - OMOLOGATE DA UNDERWRITERS LABORATORIES INC.**  
**HERMETIC CHECK VALVES - APPROVED BY UNDERWRITERS LABORATORIES INC.**  
**CLAPETS ANTI-RETOUR HERMÉTIQUES - HOMOLOGUÉS PAR UNDERWRITERS LABORATORIES INC.**  
**HERMETISCHE RÜCKSCHLAGVENTILE - ZUGELASSEN VON UNDERWRITERS LABORATORIES INC.**

Disegno Drawing Dessin Zeichnung	N° catalogo Part number N° catalogue Katalog Nr.	Attacchi Connections Raccords Anschlüsse			Kv [m <sup>3</sup> /h]	Pressione differenziale Differential pressure Pression différentielle Differenzial Druck (1) [bar]	PS [bar]	TS [°C]		Confezione n° pz Package pcs Emballage Verpackung
		SAE Flare	ODS					min	max	
			Ø [in.]	Ø [mm]						

In linea con attacchi ODS di rame / Straight with copper ODS connections / Connexions droites ODS cuivre / Durchfluss Verbindung ODS Kupfer

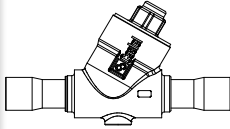
	3144W/7	7/8"	22	8,1	0,04	50 (2)	-40	+150	15	
	3144W/M28	-	28	10,4					8	
	3144W/9	1.1/8"	-	10,4					5	
	3144W/11	1.3/8"	35	15,6					1	
	3144W/13	1.5/8"	-	27						
	3144W/M42	-	42	27						
	3144W/17	2.1/8"	54	39						
	3144W/21 (4)	2.5/8"	-	39						
	3144W/25 (4)	3.1/8"	-	39		0,3			50 (2)	15
	3145W/7	7/8"	22	8,1						8
	3145W/M28	-	28	10,4	5					
	3145W/9	1.1/8"	-	10,4	1					
	3145W/11	1.3/8"	35	15,6						
	3145W/13	1.5/8"	-	27						
	3145W/M42	-	42	27						
	3145W/17	2.1/8"	54	39						
	3145W/21 (4)	2.5/8"	-	39	45		-40	+150	1	
	3145W/25 (4)	3.1/8"	-	39						

A squadra con attacchi ODS di rame / Right angle with copper ODS connections / Angle droit avec connexion cuivre ODS / Winkelanschluss mit Lötanschluss in Kupferausführung

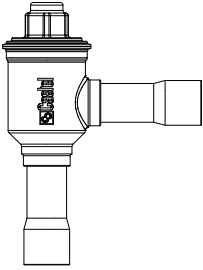
	3184W/7	7/8"	22	9	0,04	50 (3)	-40	+150	14
	3184W/M28	-	28	19					1
	3184W/9	1.1/8"	-	19					
	3184W/11	1.3/8"	35	29	0,3	45 (3)			14
	3185W/7	7/8"	22	9					1
	3185W/M28	-	28	19					
	3185W/9	1.1/8"	-	19					
	3185W/11	1.3/8"	35	29		45 (3)			

(1) Minima pressione a cui la valvola è completamente aperta

(2) MWP = 650 psi in conformità a omologazione UL

(3) MWP = 600 psi in conformità a omologazione UL

(4) non omologato UL

(1) Minimum pressure at which the valve is completely open

(2) MWP = 650 psi according to UL approval

(3) MWP = 600 psi according to UL approval

(4) not UL approved

(1) Pression minimale à laquelle la vanne est entièrement ouverte

(2) MWP = 650 psi conformément à homologation UL

(3) MWP = 600 psi conformément à homologation UL

(4) Pas approuvé UL

(1) Mindestdruck, bei dem das Ventil vollständig offen ist

(2) MWP = 650 psi in Übereinstimmung zur UL-Zulassung

(3) MWP = 600 psi in Übereinstimmung zur UL-Zulassung

(4) Ohne UL-Zertifizierung

**REGOLATORI DI CAPACITÀ - OMOLOGATI DA UNDERWRITERS LABORATORIES INC.**  
**HOT GAS BYPASS CAPACITY REGULATORS - APPROVED BY UNDERWRITERS LABORATORIES INC.**  
**RÉGULATEURS DE CAPACITÉ - HOMOLOGUÉS PAR UNDERWRITERS LABORATORIES INC.**  
**LEISTUNGSREGLER - ZUGELASSEN VON UNDERWRITERS LABORATORIES INC.**

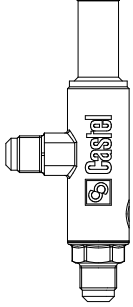
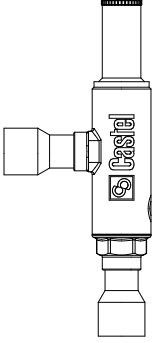
Disegno Drawing Dessin Zeichnung	N° catalogo Part number N° catalogue Katalog Nr.	Attacchi Connections Raccords Anschlüsse			Campo di regolazione Regulation range Plage de régulation Regelbereich [bar]	Kv [m <sup>3</sup> /h]	PS [bar]	TS [°C]		Confezione n° pz Package pcs Emballage Verpackung
		SAE Flare	ODS [in.]	ODS [mm]				min	max	
	3310/4	1/2"	-	-	0,2 - 6	0,70	28 (1)	- 40	+ 110	15
	3310/5	5/8"	-	-		1,26				
	3310/M12S	-	-	12	0,2 - 6	0,70	28 (1)	- 40	+ 110	15
	3310/4S	-	1/2"	-		1,26				
	3310/5S	-	5/8"	16		1,84				
	3310/7S	-	7/8"	22		8				

(1)  
MWP = 405 psi in conformità a  
omologazione UL

(1)  
MWP = 405 psi according to UL approval

(1)  
MWP = 405 psi conformément à  
homologation UL

(1)  
MWP = 405 psi in Übereinstimmung zur  
UL-Zulassung

**REGOLATORI D'AVVIAMENTO - OMOLOGATI DA UNDERWRITERS LABORATORIES INC.**  
**CRANKCASE PRESSURE REGULATORS - APPROVED BY UNDERWRITERS LABORATORIES INC.**  
**RÉGULATEURS DE PRESSION DE DÉMARRAGE - HOMOLOGUÉS PAR UNDERWRITERS LABORATORIES INC.**  
**STARTREGLER - ZUGELASSEN VON UNDERWRITERS LABORATORIES INC.**

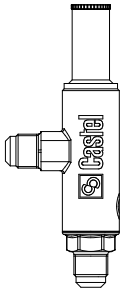
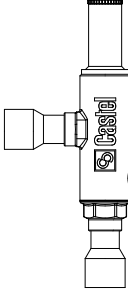
Disegno Drawing Dessin Zeichnung	N° catalogo Part number N° catalogue Katalog Nr.	Attacchi Connections Raccords Anschlüsse			Campo di regolazione Regulation range Plage de régulation Regelbereich [bar]	Kv [m <sup>3</sup> /h]	PS [bar]	TS [°C]		Confezione n° pz Package pcs Emballage Verpackung
		SAE Flare	ODS [in.]	ODS [mm]				min	max	
	3320/4	1/2"	-	-	0,2 - 6	3,3	28 (1)	- 40	+ 110	15
	3320/5	5/8"	-	-						
	3320/M12S	-	-	12	0,2 - 6	3,3	28 (1)	- 40	+ 110	15
	3320/4S	-	1/2"	-						
	3320/5S	-	5/8"	16						
	3320/7S	-	7/8"	22		8				
	3320/9S	-	1.1/8"	-						
	3320/M28S	-	-	28						
	3320/11S	-	1.3/8"	35						

(1) MWP = 405 psi in conformità a omologazione UL

(1) MWP = 405 psi according to UL approval

(1) MWP = 405 psi conformément à homologation UL

(1) MWP = 405 psi in Übereinstimmung zur UL-Zulassung

**REGOLATORI DELLA PRESSIONE D'EVAPORAZIONE - OMOLOGATI DA UNDERWRITERS LABORATORIES INC.**  
**EVAPORATING PRESSURE REGULATORS - APPROVED BY UNDERWRITERS LABORATORIES INC.**  
**RÉGULATEURS DE PRESSION D'ÉVAPORATION - HOMOLOGUÉS PAR UNDERWRITERS LABORATORIES INC.**  
**VERDAMPFUNGSDRUCKREGLER - ZUGELASSEN VON UNDERWRITERS LABORATORIES INC.**

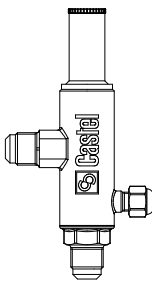
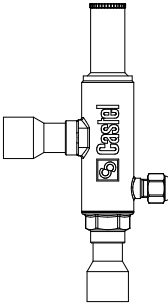
Disegno Drawing Dessin Zeichnung	N° catalogo Part number N° catalogue Katalog Nr.	Attacchi Connections Raccords Anschlüsse			Campo di regolazione Regulation range Plage de régulation Regelbereich [bar]	Kv [m³/h]	PS [bar]	TS [°C]		Confezione n° pz Package pcs Emballage Verpackung
		SAE Flare	ODS [in.]	ODS [mm]				min	max	
	3330/4	1/2"	-	-	0,2 - 5,5	2,7	28 (1)	- 40	+ 110	15
	3330/5	5/8"	-	-						
	3330/M12S	-	-	12	0,2 - 5,5	2,7	28 (1)	- 40	+ 110	15
	3330/4S	-	1/2"	-						
	3330/5S	-	5/8"	16						
	3330/7S	-	7/8"	22		8,4				
	3330/9S	-	1.1/8"	-						
	3330/M28S	-	-	28						
	3330/11S	-	1.3/8"	35						
									8	
										1

(1) MWP = 405 psi in conformità a omologazione UL

(1) MWP = 405 psi according to UL approval

(1) MWP = 405 psi conformément à homologation UL

(1) MWP = 405 psi in Übereinstimmung zur UL-Zulassung

**REGOLATORI DELLA PRESSIONE DI CONDENSAZIONE - OMOLOGATI DA UNDERWRITERS LABORATORIES INC.**  
**CONDENSING PRESSURE REGULATORS - APPROVED BY UNDERWRITERS LABORATORIES INC.**  
**RÉGULATEURS DE PRESSION DE CONDENSATION - HOMOLOGUÉS PAR UNDERWRITERS LABORATORIES INC.**  
**VERFLÜSSIGUNGSDRUCKREGLER - ZUGELASSEN VON UNDERWRITERS LABORATORIES INC.**

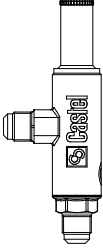
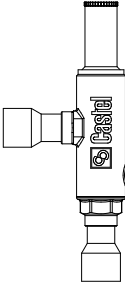
Disegno Drawing Dessin Zeichnung	N° catalogo Part number N° catalogue Katalog Nr.	Attacchi Connections Raccords Anschlüsse			Campo di regolazione Regulation range Plage de régulation Regelbereich [bar]	Kv [m³/h]	PS [bar]	TS [°C]		Confezione n° pz Package pcs Emballage Verpackung
		SAE Flare	ODS [in.]	ODS [mm]				min	max	
	3340/4	1/2"	-	-	3-20	2,7	28 (1)	- 40	+ 110	15
	3340/5	5/8"	-	-						
	3340/M12S	-	-	12	3-20	2,7	28 (1)	- 40	+ 110	15
	3340/4S	-	1/2"	-						
	3340/5S	-	5/8"	16						
	3340/7S	-	7/8"	22						
	3340/9S	-	1.1/8"	-						1
	3340/M28S	-	-	28						
	3340/11S	-	1.3/8"	35						

(1) MWP = 405 psi in conformità a omologazione UL

(1) MWP = 405 psi according to UL approval

(1) MWP = 405 psi conformément à homologation UL

(1) MWP = 405 psi in Übereinstimmung zur UL-Zulassung

**VALVOLE DIFFERENZIALE**  
**DIFFERENTIAL VALVES**  
**VANNES À PRESSION DIFFÉRENTIELLE**  
**DIFFERENZDRUCKVENTILE**

Disegno Drawing Dessin Zeichnung	N° catalogo Part number N° catalogue Katalog Nr.	Attacchi Connections Raccords Anschlüsse			Pressione differenziale d'apertura Opening differential pressure Pression différentielle d'ouverture Öffnungsdifferenzdruck [bar]	Kv [m³/h]	PS [bar]	TS [°C]		Confezione n° pz Package pcs Emballage Verpackung
		SAE Flare	ODS [in.]	OD [mm]				min	max	
	3136W/M12	-	-	12	1,4 - 3	1,5	45	- 40	+ 110	16
	3136W/4	-	1/2"	-						

**REGOLATORI DI PRESSIONE DEL RICEVITORE - OMOLOGATI DA UNDERWRITERS LABORATORIES INC.**  
**RECEIVER PRESSURE REGULATORS - APPROVED BY UNDERWRITERS LABORATORIES INC.**  
**RÉGULATEURS DE PRESSION DE BOUTEILLE - HOMOLOGUÉS PAR UNDERWRITERS LABORATORIES INC.**  
**SAMMLERDRUCKREGLER - ZUGELASSEN VON UNDERWRITERS LABORATORIES INC.**

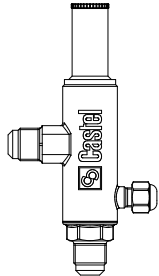
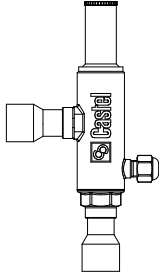
Disegno Drawing Dessin Zeichnung	N° catalogo Part number N° catalogue Katalog Nr.	Attacchi Connections Raccords Anschlüsse			Campo di regolazione Regulation range Plage de régulation Regelbereich [bar]	Kv [m <sup>3</sup> /h]	PS [bar]	TS [°C]		Confezione n° pz Package pcs Emballage Verpackung
		SAE Flare	ODS [in.]	ODS [mm]				min	max	
	3350/4	1/2"	-	-	3 - 20	1,8	28 (1)	- 40	+ 110	15
	3350/5	5/8"	-	-						
	3350/M12S	-	-	12	3 - 20	1,8	28 (1)	- 40	+ 110	15
	3350/4S	-	1/2"	-						
	3350/5S	-	5/8"	16						

(1)  
MWP = 405 psi in conformità a  
omologazione UL

(1)  
MWP = 405 psi according to UL approval

(1)  
MWP = 405 psi conformément à  
homologation UL

(1)  
MWP = 405 psi in Übereinstimmung zur  
UL-Zulassung

**INDICATORI DI LIQUIDO - OMOLOGATI DA UNDERWRITERS LABORATORIES INC.**  
**LIQUID INDICATORS - APPROVED BY UNDERWRITERS LABORATORIES INC.**  
**VOYANTS DE LIQUIDE - HOMOLOGUÉS PAR UNDERWRITERS LABORATORIES INC.**  
**FLUSSIGKEITSSCHAUGLAS - ZUGELASSEN VON UNDERWRITERS LABORATORIES INC.**

Disegno Drawing Dessin Zeichnung	N° catalogo Part number N° catalogue Katalog Nr.	Attacchi Connections Raccords Anschlüsse			PS [bar]	TS [°C]		Confezione n° pz Package pcs Emballage Verpackung
		SAE Flare	Ø ODS [in.]	Ø ODS [mm]		min	max	

**attacchi sae flare maschio - maschio / sae flare male - male connections / raccords sae flare mâle - mâle / bördelanschlüsse aussen - aussen**

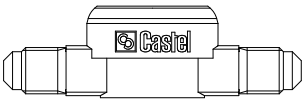
	3810/22	1/4"			50 (1)	-40	+120	20
	3810/33	3/8"						
	3810/44	1/2"	-	-				
	3810/55	5/8"						
	3810/66	3/4"						

**Attacchi sae flare maschio - femmina / sae flare male - female connections / raccords sae flare mâle - femelle / bördelanschlüsse innen - aussen**

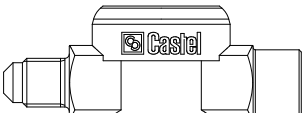
	3850/22	1/4"			50 (1)	-40	+120	20
	3850/33	3/8"						
	3850/44	1/2"	-	-				
	3850/55	5/8"						
	3850/66	3/4"						16

**Attacchi di rame a saldare / copper braze connections / raccords a souder en cuivre / kupfer lötlanschlüsse**

	3840/2		1/4"	-	50 (1)	-40	+120	25
	3840/3		3/8"	-				
	3840/M10		-	10				
	3840/M12		-	12				
	3840/4		1/2"	-				
	3840/5		5/8"	16				16
	3840/M18		-	18				
	3840/6		3/4"	-				
	3840/7		7/8"	22				
	3840/9		1.1/8"	-				

(1)  
MWP = 500 psi in conformità a  
omologazione UL

(1)  
MWP = 500 psi according to UL approval

(1)  
MWP = 500 psi conformément à  
homologation UL

(1)  
MWP = 500 psi in Übereinstimmung zur  
UL-Zulassung

**INDICATORI DI UMIDITÀ - OMOLOGATI DA UNDERWRITERS LABORATORIES INC.**  
**MOISTURE INDICATORS - APPROVED BY UNDERWRITERS LABORATORIES INC.**  
**VOYANT LIQUIDE AVEC INDICATEURS D' HUMIDITE - HOMOLOGUÉS PAR UNDERWRITERS LABORATORIES INC.**  
**FLÜSSIGKEITSINDIKATOREN - ZUGELASSEN VON UNDERWRITERS LABORATORIES INC.**

Disegno Drawing Dessin Zeichnung	N° catalogo Part number N° catalogue Katalog Nr.	Attacchi Connections Raccords Anschlüsse			PS [bar]	TS [°C]		Confezione n° pz Package pcs Emballage Verpackung
		SAE Flare	Ø ODS [in.]	Ø ODS [mm]		min	max	

**attacchi sae flare maschio - maschio / sae flare male - male connections / raccords sae flare mâle - mâle / bördelanschlüsse aussen - aussen**

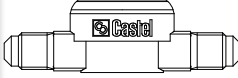
	3910/22	1/4"	-	-	50 (1)	-40	+120	20
	3910/33	3/8"						
	3910/44	1/2"						
	3910/55	5/8"						
	3910/66	3/4"						

**Attacchi sae flare maschio - femmina / sae flare male - female connections / raccords sae flare mâle - femelle / bördelanschlüsse innen - aussen**

	3950/22	1/4"	-	-	50 (1)	-40	+120	20
	3950/33	3/8"						
	3950/44	1/2"						
	3950/55	5/8"						
	3950/66	3/4"						16

**Attacchi di rame a saldare / copper braze connections / raccords a souder en cuivre / kupfer lötanschlüsse**

	3940/2	-	1/4"	-	50 (1)	-40	+120	25
	3940/3		3/8"	-				
	3940/M10		-	10				
	3940/M12		-	12				
	3940/4		1/2"	-				16
	3940/5		5/8"	16				
	3940/M18		-	18				
	3940/6		3/4"	-				
	3940/7		7/8"	22				21
	3940/9		1.1/8"	-				16

(1) MWP = 500 psi in conformità a omologazione UL | (1) MWP = 500 psi according to UL approval | (1) MWP = 500 psi conformément à homologation UL | (1) MWP = 500 psi in Übereinstimmung zur UL-Zulassung



**INDICATORI DI LIQUIDO E INDICATORI D'UMIDITÀ**  
**LIQUID AND MOISTURE INDICATORS**  
**VOYANT LIQUIDE ET INDICATEURS D' HUMIDITE**  
**FLUSSIGKEITSSCHAUGLAS UND FLÜSSIGKEITSINDIKATOREN**

Disegno Drawing Dessin Zeichnung	N° catalogo Part number N° catalogue Katalog Nr.	Attacchi Connections Raccords Anschlüsse							PS [bar]	TS [°C]		Confezione n° pz Package pcs Emballage Verpackung
		ODS		ODM		Per tubo For pipe Pour tuyau Für rohr				min	max	
		Ø [in.]	Ø [mm]	Ø [in.]	Ø [mm]	Ø [in.]	Ø [mm]	Foro Hole Orifice Loch Ø [mm]				

**Attacchi di rame a saldare / copper braze connections / raccords a souder en cuivre / kupfer lötlanschlüsse**

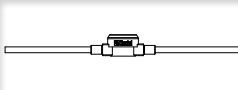
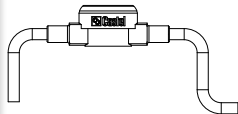
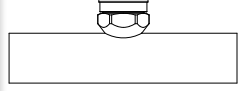
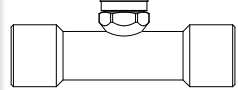
	3940/X01	-	-	-	6	-	-	-	45	-40	+120	120
	3940/X02	-	-	-	6	-	-	-	45	-40	+120	48
	3770/M28	-	-	-	28	-	-	-	-	-	-	21
	3770/11	-	-	1.3/8"	35	-	-	-	45	-30	+110	17
	3770/13	-	-	1.5/8"	-	-	-	-	-	-	-	
	3770/M42	-	-	-	42	-	-	-	-	-	-	
	3771/11	1.3/8"	35	-	-	-	-	-	45	-30	+110	17
	3771/M42	-	42	-	-	-	-	-	45	-30	+110	
	3771/17	2.1/8"	-	-	-	-	-	-	45	-30	+110	15

**A sella / saddle type / embase à braser / sattel typ**

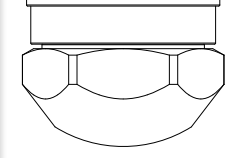
	3780/5	-	-	-	-	5/8"	16	-	-	-	-	225
	3780/M18	-	-	-	-	-	18	-	-	-	-	
	3780/7	-	-	-	-	7/8"	22	-	45	-30	+110	
	3780/9	-	-	-	-	1.1/8"	28	-	-	-	-	
	3780/11	-	-	-	-	1.3/8"	35	-	-	-	-	

**FILTRI DISIDRATATORI A CARTUCCIA SOLIDA 100% SETACCIO MOLECOLARE - ATTACCHI SAE FLARE - OMOLOGATI DA UNDERWRITERS LABORATORIES INC.**

**SOLID CORE FILTER DRIERS 100% MOLECULAR SIEVES - SAE FLARE CONNECTIONS - APPROVED BY UNDERWRITERS LABORATORIES INC.**  
**FILTRES DÉSHYDRATEURS AVEC CARTOUCHE SOLIDE 100% TAMIS MOLECULAIRE - RACCORDS SAE FLARE - HOMOLOGUÉS PAR UNDERWRITERS LABORATORIES INC.**

**FILTERTROCKNER MIT 100% MOLEKULARSIEB - BÖRDELANSCHLÜSSE - ZUGELASSEN VON UNDERWRITERS LABORATORIES INC.**

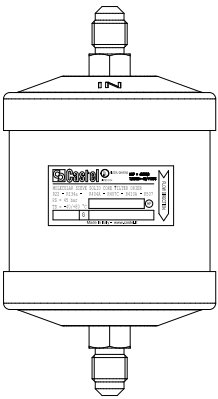
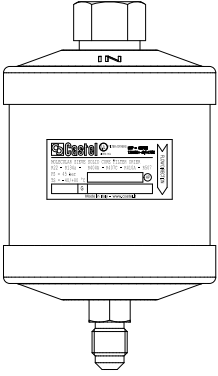
Disegno Drawing Dessin Zeichnung	N° catalogo Part number N° Catalogue Katalog Nr	Codice internazionale International code Code international Internationaler code	Attacchi SAE Flare Connections SAE Flare Raccords SAE Flare Anschlüsse SAE Flare	Cubatura nominale Nominal volume Cubature nominale Nominaler rauminhalt [cm³]	PS [bar]	TS [°C]		Confezione n° pz Package pcs Emballage Verpackung
						min	max	
	DF303/2	032	1/4"	50	50 (1)	-40	+80	25
	DF303/3	033	3/8"					
	DF305/2	052	1/4"	80				25
	DF305/3	053	3/8"					
	DF308/2	082	1/4"	130				25
	DF308/3	083	3/8"					
	DF308/4	084	1/2"					
	DF316/2	162	1/4"	250				15
	DF316/3	163	3/8"					
	DF316/4	164	1/2"					
	DF316/5	165	5/8"	500				10
	DF330/3	303	3/8"					
	DF330/4	304	1/2"					
	DF330/5	305	5/8"					
	DF330/6	306	3/4"	670				6
	DF341/4	414	1/2"					
DF341/5	415	5/8"						
DF341/6	416	3/4"						
	DF303/2F		1/4"	50	50 (1)	-40	+80	25
	DF305/2F		1/4"					
	DF308/2F	-	1/4"	130				25
	DF308/3F		3/8"					
	DF316/3F		3/8"	250				15

(1) MWP = 680 psi in conformità a omologazione UL

(1) MWP = 680 psi according to UL approval

(1) MWP = 680 psi conformément à homologation UL

(1) MWP = 680 psi in Übereinstimmung zur UL-Zulassung

**FILTRI DISIDRATORI A CARTUCCIA SOLIDA 100% SETACCIO MOLECOLARE - ATTACCHI A SALDARE - OMOLOGATI DA UNDERWRITERS LABORATORIES INC.**

**SOLID CORE FILTER DRIERS 100% MOLECULAR SIEVES - SOLDER CONNECTIONS - APPROVED BY UNDERWRITERS LABORATORIES INC.**  
**FILTRES DÉSHYDRATEURS AVEC CARTOUCHE SOLIDE 100% TAMIS MOLECULAIRE - RACCORDE A SOUDER - HOMOLOGUÉS PAR UNDERWRITERS LABORATORIES INC.**

**FILTERTROCKNER MIT 100% MOLEKULARSIEB - LÖTANSCHLÜSSE - ZUGELASSEN VON UNDERWRITERS LABORATORIES INC.**

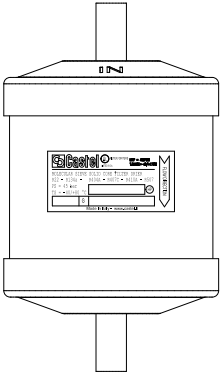
Disegno Dessin Zeichnung	N° catalogo Part number N° catalogue Katalog Nr.	Codice internazionale International code Code international Internationaler Code	Attacchi Connections Raccords Anschlüsse ODS		Cubatura nominale Nominal volume Cubature nominale Nominaler Rauminhalt [cm³]	PS [bar]	TS [°C]		Confezione n° pz Package pcs Emballage Verpackung
			Ø [in.]	Ø [mm]			min	max	
	DF303/2S	032S	1/4"	-	50	50 (1)	-40	+80	25
	DF303/3S	033S	3/8"	-					
	DF305/2S	052S	1/4"	-	80				25
	DF305/3S	053S	3/8"	-					
	DF305/M10S	-	-	10	130				25
	DF308/2S	082S	1/4"	-					
	DF308/3S	083S	3/8"	-					
	DF308/M10S	-	-	10					
	DF308/M12S	-	-	12	250				15
	DF308/4S	084S	1/2"	-					
	DF316/3S	163S	3/8"	-					
	DF316/M10S	-	-	10					
	DF316/M12S	-	-	12	500				10
	DF316/4S	164S	1/2"	-					
	DF316/5S	165S	5/8"	16					
	DF316/7S	167S	7/8"	-					
	DF330/3S	303S	3/8"	-	670				6
	DF330/4S	304S	1/2"	-					
	DF330/5S	305S	5/8"	16					
	DF330/6S	306S	3/4"	-					
	DF330/7S	307S	7/8"	-	1340				1
	DF341/4S	414S	1/2"	-					
	DF341/5S	415S	5/8"	16					
	DF341/6S	416S	3/4"	-					
	DF341/7S	417S	7/8"	-	1340				1
	DF375/4S	754S	1/2"	-					
	DF375/5S	755S	5/8"	16					
	DF375/6S	756S	3/4"	-					
DF375/7S	757S	7/8"	-	1340	1				
DF375/9S	759S	1.1/8"	-						

(1) MWP = 680 psi in conformità a omologazione UL

(1) MWP = 680 psi according to UL approval

(1) MWP = 680 psi conformément à homologation UL

(1) MWP = 680 psi in Übereinstimmung zur UL-Zulassung

**FILTRI DISIDRATORI A CARTUCCIA SOLIDA 80% SETACCIO MOLECOLARE, 20% ALLUMINA - ATTACCHI SAE FLARE - OMOLOGATI DA UNDERWRITERS LABORATORIES INC.**

**DEHYDRATOR FILTERS WITH SOLID CORE 80% MOLECULAR SIEVE, 20% ALUMINA - SAE FLARE CONNECTIONS - APPROVED BY UNDERWRITERS LABORATORIES INC.**

**FILTRES DÉSHYDRATEURS AVEC CARTOUCHE SOLIDE 80% TAMIS MOLECULAIRE, 20% ALUMINE - RACCORDS SAE FLARE - HOMOLOGUÉS PAR UNDERWRITERS LABORATORIES INC.**

**FILTERTROCKNER MIT 80% MOLEKULARSIEB, 20% ALUMINIUMOXID - BÖRDELANSCHLÜSSE - ZUGELASSEN VON UNDERWRITERS LABORATORIES INC.**

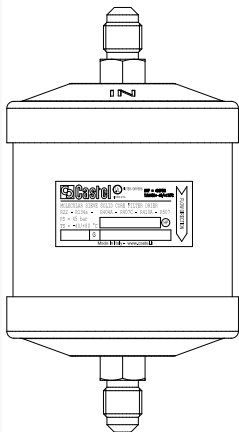
Disegno Drawing Dessin Zeichnung	N° catalogo Part number N° Catalogue Katalog Nr	Codice internazionale International code Code international Internationaler code	Attacchi SAE Flare Connections SAE Flare Raccords SAE Flare Anschlüsse SAE Flare	Cubatura nominale Nominal volume Cubature nominale Nominaler rauminhalt [cm³]	PS [bar]	TS [°C]		Confezione n° pz Package pcs Emballage Verpackung
						min	max	
	DF203/2	032	1/4"	50	50 (1)	-40	+80	25
	DF203/3	033	3/8"					
	DF205/2	052	1/4"	80				25
	DF205/3	053	3/8"					
	DF208/2	082	1/4"	130				25
	DF208/3	083	3/8"					
	DF208/4	084	1/2"					
	DF216/2	162	1/4"	250				15
	DF216/3	163	3/8"					
	DF216/4	164	1/2"					
	DF216/5	165	5/8"					
	DF230/3	303	3/8"	500				10
	DF230/4	304	1/2"					
	DF230/5	305	5/8"					
	DF241/5	415	5/8"	670				6
	DF241/6	416	3/4"					

(1) MWP = 680 psi in conformità a omologazione UL

(1) MWP = 680 psi according to UL approval

(1) MWP = 680 psi conformément à homologation UL

(1) MWP = 680 psi in Übereinstimmung zur UL-Zulassung

**FILTRI DISIDRATATORI A CARTUCCIA SOLIDA 80% SETACCIO MOLECOLARE, 20% ALLUMINA - ATTACCHI A SALDARE - OMOLOGATI DA UNDERWRITERS LABORATORIES INC.**  
**DEHYDRATOR FILTERS WITH SOLID CORE 80% MOLECULAR SIEVE, 20% ALUMINA - SOLDER CONNECTIONS - APPROVED BY UNDERWRITERS LABORATORIES INC.**  
**FILTRES DÉSHYDRATEURS AVEC CARTOUCHE SOLIDE 80% TAMIS MOLECULAIRE, 20% ALUMINE - RACCORDE A SOUDER - HOMOLOGUÉS PAR UNDERWRITERS LABORATORIES INC.**  
**FILTERTROCKNER MIT 80% MOLEKULARSIEB, 20% ALUMINIUMOXID - LÖTANSCHLÜSSE - ZUGELASSEN VON UNDERWRITERS LABORATORIES INC.**

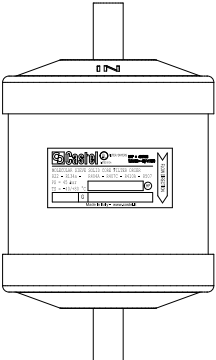
Disegno Drawing Dessin Zeichnung	N° catalogo Part number N° catalogue Katalog Nr.	Codice internazionale International code Code international Internationaler Code	Attacchi Connections Raccords Anschlüsse ODS		Cubatura nominale Nominal volume Cubature nominale Nominaler Rauminhalt [cm³]	PS [bar]	TS [°C]		Confezione n° pz Package pcs Emballage Verpackung
			Ø [in.]	Ø [mm]			min	max	
	DF203/2S	032S	1/4"	-	50	50 (1)	-40	+80	25
	DF203/3S	033S	3/8"	-					
	DF205/2S	052S	1/4"	-	80				25
	DF205/3S	053S	3/8"	-					
	DF205/M10S	-	-	10	130				25
	DF208/2S	082S	1/4"	-					
	DF208/3S	083S	3/8"	-					
	DF208/M10S	-	-	10					
	DF208/M12S	-	-	12	250				15
	DF208/4S	084S	1/2"	-					
	DF216/3S	163S	3/8"	-					
	DF216/M10S	-	-	10					
	DF216/M12S	-	-	12	500				10
	DF216/4S	164S	1/2"	-					
	DF216/5S	165S	5/8"	16					
	DF216/7S	167S	7/8"	-	670				6
	DF230/3S	303S	3/8"	-					
	DF230/4S	304S	1/2"	-					
	DF230/5S	305S	5/8"	16	1340				1
	DF230/7S	307S	7/8"	-					
	DF241/5S	415S	5/8"	16					
	DF241/6S	416S	3/4"	-					
	DF241/7S	417S	7/8"	-					
	DF275/4S	754S	1/2"	-	1340				1
	DF275/5S	755S	5/8"	16					
	DF275/6S	756S	3/4"	-					
	DF275/7S	757S	7/8"	-					
	DF275/9S	759S	1.1/8"	-					

(1) MWP = 680 psi in conformità a omologazione UL | (1) MWP = 680 psi according to UL approval | (1) MWP = 680 psi conformément à homologation UL | (1) MWP = 680 psi in Übereinstimmung zur UL-Zulassung

**FILTRI DISIDRATORI BIFLUSSO A CARTUCCIA SOLIDA 100% SETACCIO MOLECOLARE - ATTACCHI SAE FLARE OMOLOGATI DA UNDERWRITERS LABORATORIES INC.**

**SOLID CORE BI-FLOW FILTER DRIERS 100% MOLECULAR SIEVES - SAE FLARE CONNECTIONS APPROVED BY UNDERWRITERS LABORATORIES INC.**

**FILTRES DÉSHYDRATEURS BIDIRECTIONNELS AVEC CARTOUCHE SOLIDE 100% TAMIS MOLECULAIRE - RACCORDS SAE FLARE HOMOLOGUÉS PAR UNDERWRITERS LABORATORIES INC.**

**BI-FLOW FILTERTROCKNER 100% MOLEKULARSIEB - BÖRDELANSCHLUSS ZUGELASSEN VON UNDERWRITERS LABORATORIES INC.**

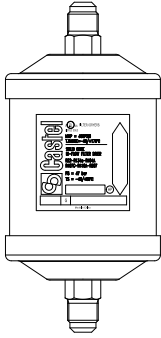
Disegno Drawing Dessin Zeichnung	N° catalogo Part number N° catalogue Katalog Nr.	Codice internazionale International code Code international Internationaler Code	Attacchi Connections Raccords Anschlüsse SAE Flare		Cubatura nominale Nominal volume Cubature nominale Nominaler Rauminhalt [cm³]	PS [bar]	TS [°C]		Confezione n° pz Package pcs Emballage Verpackung
			Ø [in.]				min	max	
	DB305/2	052	1/4"		80	50 (1)	-40	+80	25
	DB308/3	083	3/8"		130				25
	DB308/4	084	1/2"						
	DB316/3	163	3/8"		250				15
	DB316/4	164	1/2"						
	DB316/5	165	5/8"						
	DB330/5	305	5/8"		500				10

(1) MWP = 680 psi in conformità a omologazione UL

(1) MWP = 680 psi according to UL approval

(1) MWP = 680 psi conformément à homologation UL

(1) MWP = 680 psi in Übereinstimmung zur UL-Zulassung

**FILTRI DISIDRATORI BIFLUSSO A CARTUCCIA SOLIDA 100% SETACCIO MOLECOLARE - ATTACCHI A SALDARE OMOLOGATI DA UNDERWRITERS LABORATORIES INC.**

**SOLID CORE BI-FLOW FILTER DRIERS 100% MOLECULAR SIEVES - SOLDER CONNECTIONS APPROVED BY UNDERWRITERS LABORATORIES INC.**

**FILTRES DÉSHYDRATEURS BIDIRECTIONNELS AVEC CARTOUCHE SOLIDE 100% TAMIS MOLECULAIRE - RACCORDS A SOUDER HOMOLOGUÉS PAR UNDERWRITERS LABORATORIES INC.**

**BI-FLOW FILTERTROCKNER 100% MOLEKULARSIEB - LÖTANSCHLUSS ZUGELASSEN VON UNDERWRITERS LABORATORIES INC.**

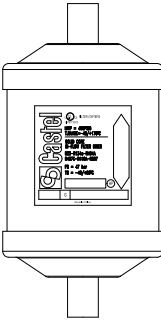
Disegno Drawing Dessin Zeichnung	N° catalogo Part number N° catalogue Katalog Nr.	Codice internazionale International code Code international Internationaler Code	Attacchi Connections Raccords Anschlüsse ODS		Cubatura nominale Nominal volume Cubature nominale Nominaler Rauminhalt [cm³]	PS [bar]	TS [°C]		Confezione n° pz Package pcs Emballage Verpackung
			Ø [in.]	Ø [mm]			min	max	
	DB305/2S	052S	1/4"	-	80	50 (1)	-40	+80	25
	DB308/3S	083S	3/8"	-	130				25
	DB308/4S	084S	1/2"	-					
	DB316/3S	163S	3/8"	-	250				15
	DB316/4S	164S	1/2"	-					
	DB316/5S	165S	5/8"	16					
	DB316/7S	167S	7/8"	-					
	DB330/5S	305S	5/8"	16	500				10
	DB330/7S	307S	7/8"	-					
	DB330/9S	309S	1.1/8"	-					

(1) MWP = 680 psi in conformità a omologazione UL

(1) MWP = 680 psi according to UL approval

(1) MWP = 680 psi conformément à homologation UL

(1) MWP = 680 psi in Übereinstimmung zur UL-Zulassung

**FILTRI DISIDRATATORI A CARTUCCIA SOLIDA RICAMBIABILE - ATTACCHI DI RAME - OMOLOGATI DA UNDERWRITERS LABORATORIES INC.**  
**FILTER DRIERS WITH REPLACEABLE SOLID CORE - COPPER CONNECTIONS - APPROVED BY UNDERWRITERS LABORATORIES INC.**  
**FILTRES DÉSHYDRATEURS AVEC CARTOUCHE SOLIDE REMPLAÇABLE - RACCORDS EN CUIVRE - HOMOLOGUÉS PAR UNDERWRITERS LABORATORIES INC.**  
**FILTERTROCKNER FÜR UNIVERSAL BLOCKEINSATZ - KUPFER-ANSCHLÜSSE - ZUGELASSEN VON UNDERWRITERS LABORATORIES INC.**

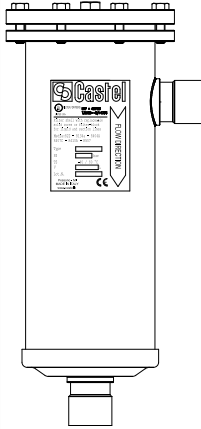
Disegno Drawing Dessin Zeichnung	N° Catalogo Part number N° Catalogue Katalog Nr		Attacchi Connections Raccords Anschlüsse ODS		Tipo cartucce Cores type Type cartouches Patronentyp	N° cartucce N° of cores N° cartouches Patronenanzahl	Cubatura nominale Nominal volume Cubature nominale Nominaler rauminhalt [cm³]	PS [bar]	TS [°C]		Confezione n° pz Package pcs Emballage Verpackung
	Coperchio filettato Threaded cover Couvercle fileté Schraubkappe	Coperchio cieco Blind cover Couvercle borgne Blindkappe	Ø [in.]	Ø [mm]					Min	Max	
	SF411/5A	SF411/5B	5/8"	16	4490/A 4490/B 4490/AA 4490/AB	1	800	47 (1)			1
	SF411/7A	SF411/7B	7/8"	22							
	SF411/M28A	SF411/M28B	-	28							
	SF411/9A	SF411/9B	1.1/8"	-							
	SF411/11A	SF411/11B	1.3/8"	35							
	SF411/13A	SF411/13B	1.5/8"	-							
	SF411/M42A	SF411/M42B	-	42							
	SF411/17A	SF411/17B	2.1/8"	54							
	SF411/21A	SF411/21B	2.5/8"	-							
	SF412/5A	SF412/5B	5/8"	16							
	SF412/7A	SF412/7B	7/8"	22							
	SF412/M28A	SF412/M28B	-	28							
	SF412/9A	SF412/9B	1.1/8"	-							
	SF412/11A	SF412/11B	1.3/8"	35							
	SF412/13A	SF412/13B	1.5/8"	-							
	SF412/M42A	SF412/M42B	-	42							
	SF412/17A	SF412/17B	2.1/8"	54							
	SF412/21A	SF412/21B	2.5/8"	-							
	SF413/7A	SF413/7B	7/8"	22							
	SF413/M28A	SF413/M28B	-	28							
	SF413/9A	SF413/9B	1.1/8"	-							
	SF413/11A	SF413/11B	1.3/8"	35							
	SF413/13A	SF413/13B	1.5/8"	-							
	SF413/M42A	SF413/M42B	-	42							
SF413/17A	SF413/17B	2.1/8"	54								
SF414/11A	SF414/11B	1.3/8"	35								
SF414/13A	SF414/13B	1.5/8"	-								
SF414/M42A	SF414/M42B	-	42								
SF414/17A	SF414/17B	2.1/8"	54								

(1)  
MWP = 600 psi in conformità a omologazione UL

(2)  
MWP = 450 psi in conformità a omologazione UL

(1)  
MWP = 600 psi according to UL approval

(2)  
MWP = 450 psi according to UL approval

(1)  
MWP = 600 psi conformément à homologation UL

(2)  
MWP = 450 psi conformément à homologation UL

(1)  
MWP = 600 psi in Übereinstimmung zur UL-Zulassung

(2)  
MWP = 450 psi in Übereinstimmung zur UL-Zulassung

**FILTRI DISIDRATATORI A CARTUCCIA SOLIDA RICAMBIABILE - ATTACCHI DI RAME - OMOLOGATI DA UNDERWRITERS LABORATORIES INC.**  
**FILTER DRIERS WITH REPLACEABLE SOLID CORE - COPPER CONNECTIONS - APPROVED BY UNDERWRITERS LABORATORIES INC.**  
**FILTRES DÉSHYDRATEURS AVEC CARTOUCHE SOLIDE REMPLAÇABLE - RACCORDS EN CUIVRE - HOMOLOGUÉS PAR UNDERWRITERS LABORATORIES INC.**  
**FILTERTROCKNER FÜR UNIVERSAL BLOCKEINSATZ - KUPFER-ANSCHLÜSSE - ZUGELASSEN VON UNDERWRITERS LABORATORIES INC.**

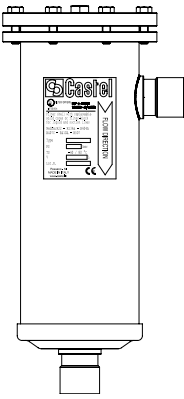
Disegno Drawing Dessin Zeichnung	N° Catalogo Part number N° Catalogue Katalog Nr		Attacchi Connections Raccords Anschlüsse		Tipo cartucce Cores type Type cartouches Patronentyp	N° cartucce N° of cores N° cartouches Patronenanzahl	Cubatura nominale Nominal volume Cubature nominale Nominaler rauminhalt [cm³]	PS [bar]	TS [°C]		Confezione n° pz Package pcs Emballage Verpackung
	Coperchio filettato Threaded cover Couvercle fileté Schraubkappe	Coperchio cieco Blind cover Couvercle borgne Blindkappe	ODS						Min	Max	
			Ø [in.]	Ø [mm]							
	4411/5A	4411/5B	5/8"	16	4490/A 4490/B 4490/AA 4490/AB	1	800	45 (1)			1
	4411/7A	4411/7B	7/8"	22							
	4411/M28A	4411/M28B	-	28							
	4411/9A	4411/9B	1.1/8"	-							
	4411/11A	4411/11B	1.3/8"	35							
	4411/13A	4411/13B	1.5/8"	-							
	4411/M42A	4411/M42B	-	42							
	4411/17A	4411/17B	2.1/8"	54							
	4411/21A	4411/21B	2.5/8"	-	3	2400					
	4412/7A	4412/7B	7/8"	22							
	4412/M28A	4412/M28B	-	28							
	4412/9A	4412/9B	1.1/8"	-							
	4412/11A	4412/11B	1.3/8"	35							
	4412/13A	4412/13B	1.5/8"	-							
	4412/M42A	4412/M42B	-	42							
	4412/17A	4412/17B	2.1/8"	54							4
	4413/7A	4413/7B	7/8"	22							
	4413/9A	4413/9B	1.1/8"	-							
	4413/11A	4413/11B	1.3/8"	35							
	4413/13A	4413/13B	1.5/8"	-							
	4413/M42A	4413/M42B	-	42							
	4414/11A	4414/11B	1.3/8"	35							
	4414/13A	4414/13B	1.5/8"	-							
	4414/M42A	4414/M42B	-	42							
4414/17A	4414/17B	2.1/8"	54								

(1) MWP = 470 psi in conformità a omologazione UL

(1) MWP = 470 psi according to UL approval

(1) MWP = 470 psi conformément à homologation UL

(1) MWP = 470 psi in Übereinstimmung zur UL-Zulassung

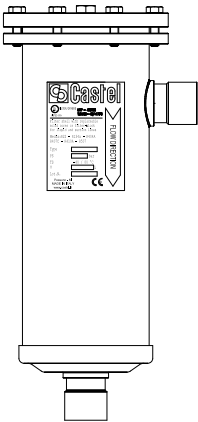

**FILTRI DISIDRATATORI A CARTUCCIA SOLIDA RICAMBIABILE- ATTACCHI D'ACCIAIO - OMOLOGATI DA UNDERWRITERS LABORATORIES INC.**  
**FILTER DRIERS WITH REPLACEABLE SOLID CORE - STEEL CONNECTIONS - APPROVED BY UNDERWRITERS LABORATORIES INC.**  
**FILTRES DÉSHYDRATEURS AVEC CARTOUCHE SOLIDE REMPLAÇABLE - RACCORDS EN ACIER - HOMOLOGUÉS PAR UNDERWRITERS LABORATORIES INC.**  
**FILTERTROCKNER FÜR UNIVERSAL BLOCKEINSATZ - STAHL-ANSCHLÜSSE - ZUGELASSEN VON UNDERWRITERS LABORATORIES INC.**

Disegno Drawing Dessin Zeichnung	N° Catalogo Part number N° Catalogue Katalog Nr	Attacchi Connections Raccords Anschlüsse			Tipo cartucce Cores type Type cartouches Patronentyp	N° cartucce N° of cores N° cartouches Patronenanzahl	Cubatura nominale Nominal volume Cubature nominale Nominaler Rauminhalt [cm <sup>3</sup> ]	PS [bar]		TS [°C]		Confezione n° pz Package pcs Emballage Verpackung
		Coperchio filettato Threaded cover Couvercle fileté Schraubkappe	ODS					W	Min	Max		
			Ø [in.]	Ø [mm]				Ø [mm]				
	4411/5AF	5/8"	16	21,3	4490/A 4490/B 4490/AA 4490/AB	800	50 (1)	-40	+80	1		
	4411/7AF	7/8"	22	26,9								
	4411/9AF	1.1/8"	-	33,7								
	4411/11AF	1.3/8"	35	42,4								
	4411/13AF	1.5/8"	-	48,3								
	4411/M42AF	-	42	48,3								
	4411/17AF	2.1/8"	54	60,3								
	4412/7AF	7/8"	22	26,9		1600	50 (1)					
	4412/9AF	1.1/8"	-	33,7								
	4412/11AF	1.3/8"	35	42,4								
	4412/13AF	1.5/8"	-	48,3								
	4412/M42AF	-	42	48,3								
	4412/17AF	2.1/8"	54	60,3								
	4413/7AF	7/8"	22	26,9							2400	45 (1)
	4413/9AF	1.1/8"	-	33,7								
	4413/11AF	1.3/8"	35	42,4								
	4413/13AF	1.5/8"	-	48,3								
	4413/M42AF	-	42	48,3								
	4414/11AF	1.3/8"	35	42,4		3200	35 (1)					
	4414/13AF	1.5/8"	-	48,3								
	4414/M42AF	-	42	48,3								
	4414/17AF	2.1/8"	54	60,3								
	4423/17A	2.1/8"	54	60,3	4491/A 4491/AA	4800	32 (1)					
	4423/21A	2.5/8"	67	76,1								
	4423/25A	3.1/8"	80	88,9								
4424/25A	3.1/8"	80	88,9									
4424/34A	4.1/4"	108	114,3									

(1) MWP = 470 psi in conformità a omologazione UL | (1) MWP = 470 psi according to UL approval | (1) MWP = 470 psi conformément à homologation UL | (1) MWP = 470 psi in Übereinstimmung zur UL-Zulassung

**ACCESSORI PER FILTRI 44 E SF4**  
**ACCESSORIES FOR 44 AND SF4 FILTER DRIES**  
**ACCESSOIRES POUR FILTRES 44 ET SF4**  
**ZUBEHÖR FÜR FILTERTROCKNER 44 UND SF4**

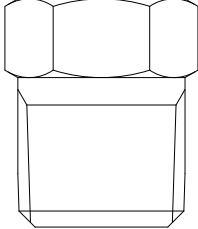
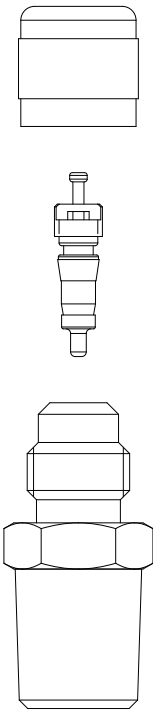
Disegno Drawing Dessin Zeichnung	N° catalogo Part number N° catalogue Katalog Nr.	Componenti Parts Composant Komponenten	Confezione n° pz Package pcs Emballage Verpackung
	7520/2	<p>Tappo NPT NPT plug Bouchons NPT NPT Verschluss</p>	25
	G9150/R05	<p>Attacco di carica + meccanismo + cappuccio Access fitting + valve core + cap Raccords de charge + mécanismes+ capuchons Schraderventil + Ventileinsatz + Kappen</p>	1

**CARTUCCE PER FILTRI DISIDRATATORI**  
**CARTRIDGES**  
**CARTOUCHE SOLIDE**  
**BLOCKEINSÄTZE**

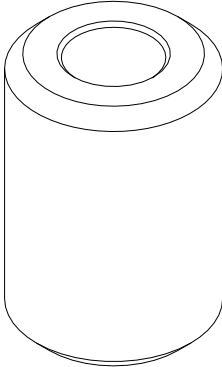
Disegno Drawing Dessin Zeichnung	N° catalogo Part number N° Catalogue Katalog Nr	Carica disidratante Dehydrating charge Charge déshydratant Bindemittel	Cubatura nominale Nominal volume Cubature nominale Nominaler Rauminhalt [cm³]	Adatta per filtri Suitable for filter Adapté pour filtre Passend für Filter	Confezione n° pz Package pcs Emballage Verpackung
	4490/A (1)	100 % Setaccio molecolare 100% Molecular sieve 100% Tamis moleculaire 100% Molekularsieb	800	4411/A-/B-/AF 4412/A-/B-/AF 4413/A-/B-/AF 4414/A-/B-/AF	15
	4490/B (2)	100 % Setaccio molecolare 100% Molecular sieve 100% Tamis moleculaire 100% Molekularsieb	800	4411/A-/B-/AF 4412/A-/B-/AF 4413/A-/B-/AF 4414/A-/B-/AF	15
	4490/AA (1)	80% Setaccio molecolare + 20% allumina attivata 80% Molecular sieve + 20% activated alumina 80% Tamis moleculaire + 20% alumine activee 80% molekularsieb + 20% aktivem Aluminium	800	4411/A-/B-/AF 4412/A-/B-/AF 4413/A-/B-/AF 4414/A-/B-/AF	15
	4490/AB (2)	80% Setaccio molecolare + 20% allumina attivata 80% Molecular sieve +20% activated alumina 80% Tamis moleculaire +20% alumine activee 80% molekularsieb +20% aktivem Aluminium	800	4411/A-/B-/AF 4412/A-/B-/AF 4413/A-/B-/AF 4414/A-/B-/AF	15
	4491/A (3)	100 % Setaccio molecolare 100% Molecular sieve 100% Tamis moleculaire 100% Molekularsieb	1600	4423/A 4424/A	8
	4491/AA (3)	80% Setaccio molecolare + 20% allumina attivata 80% Molecular sieve +20% activated alumina 80% Tamis moleculaire +20% alumine activee 80% molekularsieb +20% aktivem Aluminium	1600	4423/A 4424/A	8

(1)  
Fornita con guarnizioni di ricambio del coperchio, sia per filtri Castel sia per filtri della concorrenza

(2)  
Fornita senza guarnizione di ricambio della controflangia del filtro

(3)  
Fornita con guarnizione di ricambio del coperchio del filtro Castel

(1)  
Supplied with cover gasket as spare part, either for Castel filters or for competitors ones

(2)  
Supplied without cover gasket as spare part

(3)  
Supplied with cover gasket as spare part for Castel filter

(1)  
Fournie avec joints de rechange du couvercle aussi bien pour les filtres Castel que pour les filtres de la concurrence

(2)  
Fournie sans joint de rechange du couvercle du filtre

(3)  
Fournie avec joint de rechange du couvercle du filtre Castel

(1)  
Geliefert mit Ersatzdichtungen für den Deckel sowohl für Filter von Castel als auch Filter der Konkurrenz.

(2)  
Ohne Ersatzdichtung für Filtergegenflansch geliefert

(3)  
Geliefert mit Ersatzdichtung für den Deckel des Filters von Castel

**FILTRI A CARTUCCIA MECCANICA RICAMBIABILE - ATTACCHI DI RAME E COPERCHIO FILETTATO - OMOLOGATI DA UNDERWRITERS LABORATORIES INC.**

**MECHANICAL FILTERS WITH REPLACEABLE FILTERING BLOCK - COPPER CONNECTIONS AND THREADED COVER - APPROVED BY UNDERWRITERS LABORATORIES INC.**

**FILTRES A CARTOUCHE MÉCANIQUE REMPLAÇABLES - RACCORDS EN CUIVRE ET COUVERCLE FILETÉ - HOMOLOGUÉS PAR UNDERWRITERS LABORATORIES INC.**

**MECHANISCHE SAUGLEITUNGSFILTER - KUPFERANSCHLÜSSE UND SCHRAUBKAPPE - ZUGELASSEN VON UNDERWRITERS LABORATORIES INC.**

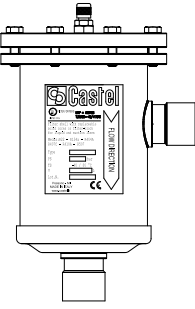
Disegno Drawing Dessin Zeichnung	N° catalogo Part number N° catalogue Katalog Nr	Attacchi Connections Raccords Anschlüsse ODS		Tipo cartuccia Cartridge type Type cartouches Patrontyp	Superficie filtrante Filtering surface Surface filtrante Filterflaeche [cm²]	PS [bar]	TS [°C]		Confezione n° pz Package pcs Emballage Verpackung
		Ø [in.]	Ø [mm]				Min	Max	
	SF411/5C	5/8"	16	4495/C	820	47 (1)	-40	+80	1
	SF411/7C	7/8"	22						
	SF411/M28C	-	28						
	SF411/9C	1.1/8"	-						
	SF411/11C	1.3/8"	35						
	SF411/13C	1.5/8"	-						
	SF411/M42C	-	42						
	SF411/17C	2.1/8"	54						
	SF411/21C	2.5/8"	-						

(1)  
MWP = 600 psi in conformità a omologazione UL

(1)  
MWP = 600 psi according to UL approval

(1)  
MWP = 600 psi conformément à homologation UL

(1)  
MWP = 600 psi in Übereinstimmung zur UL-Zulassung

**FILTRI A CARTUCCIA MECCANICA RICAMBIABILE - ATTACCHI DI RAME E COPERCHIO FILETTATO - OMOLOGATI DA UNDERWRITERS LABORATORIES INC.**

**MECHANICAL FILTERS WITH REPLACEABLE FILTERING BLOCK - COPPER CONNECTIONS AND THREADED COVER - APPROVED BY UNDERWRITERS LABORATORIES INC.**

**FILTRES A CARTOUCHE MÉCANIQUE REMPLAÇABLES - RACCORDS EN CUIVRE ET COUVERCLE FILETÉ - HOMOLOGUÉS PAR UNDERWRITERS LABORATORIES INC.**

**MECHANISCHE SAUGLEITUNGSFILTER - KUPFERANSCHLÜSSE UND SCHRAUBKAPPE - ZUGELASSEN VON UNDERWRITERS LABORATORIES INC.**

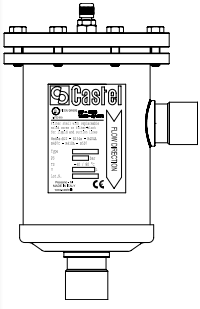
Disegno Drawing Dessin Zeichnung	N° catalogo Part number N° catalogue Katalog Nr	Attacchi Connections Raccords Anschlüsse		Tipo cartuccia Cartridge type Type cartouches Patrontyp	Superficie filtrante Filtering surface Surface filtrante Filterflaeche [cm²]	PS [bar]	TS [°C]		Confezione n° pz Package pcs Emballage Verpackung
		ODS					Min	Max	
		Ø [in.]	Ø [mm]						
	4411/5C	5/8"	16	4495/C	820	45 (1)	-40	+80	1
	4411/7C	7/8"	22						
	4411/M28C	-	28						
	4411/9C	1.1/8"	-						
	4411/11C	1.3/8"	35						
	4411/13C	1.5/8"	-						
	4411/M42C	-	42						
	4411/17C	2.1/8"	54						
	4411/21C	2.5/8"	-						

(1)  
MWP = 470 psi in conformità a omologazione UL

(1)  
MWP = 470 psi according to UL approval

(1)  
MWP = 470 psi conformément à homologation UL

(1)  
MWP = 470 psi in Übereinstimmung zur UL-Zulassung

FILTRI A CARTUCCIA MECCANICA RICAMBIABILE - ATTACCHI D'ACCIAIO E COPERCHIO FILETTATO - OMOLOGATI DA UNDERWRITERS LABORATORIES INC.

MECHANICAL FILTERS WITH REPLACEABLE FILTERING BLOCK - STEEL CONNECTIONS AND THREADED COVER - APPROVED BY UNDERWRITERS LABORATORIES INC.

FILTRES A CARTOUCHE MÉCANIQUE REMPLAÇABLES - RACCORDS EN ACIER ET COUVERCLE FILETÉ - HOMOLOGUÉS PAR UNDERWRITERS LABORATORIES INC.

MECHANISCHE SAUGLEITUNGSFILTER - STAHLANSCHLÜSSE UND SCHRAUBKAPPE - ZUGELASSEN VON UNDERWRITERS LABORATORIES INC.

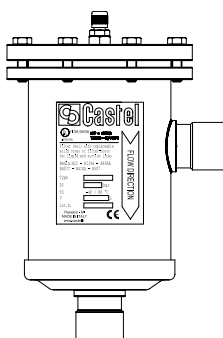
Disegno Drawing Dessin Zeichnung	N° catalogo Part number N° catalogue Katalog Nr.	Attacchi Connections Raccords Anschlüsse			Tipo cartuccia Cartridge type Type cartouches Patrontyp	Superficie filtrante Filtering surface Surface filtrante Filterfläche [cm <sup>2</sup> ]	PS [bar]	TS [°C]		Confezione n° pz Package pcs Emballage Verpackung
		ODS		W				min	max	
		Ø [in.]	Ø [mm]	Ø [mm]						
	4411/5CF	5/8"	16	21,3	4495/C	820	50 (1)	-40	+80	1
	4411/7CF	7/8"	22	26,9						
	4411/9CF	1.1/8"	-	33,7						
	4411/11CF	1.3/8"	35	42,4						
	4411/13CF	1.5/8"	-	48,3						
	4411/M42CF	-	42	48,3						
	4411/17CF	2.1/8"	54	60,3						
	4411/21CF	2.5/8"	-	76,1						
	4411/25CF	3.1/8"	80	88,9						
	4421/21C	2.5/8"	67	76,1						
	4421/25C	3.1/8"	80	88,9						
	4421/34C	4.1/4"	108	114,3						

(1) MWP = 470 psi in conformità a omologazione UL

(1) MWP = 470 psi according to UL approval

(1) MWP = 470 psi conformément à homologation UL

(1) MWP = 470 psi in Übereinstimmung zur UL-Zulassung

**CARTUCCE PER FILTRI MECCANICI**  
**BLOCKS**  
**CARTOUCHE PUOR FILTRES MÉCANIQUE**  
**FILTREINSATZ FÜR MECHANISCHE FILTER**

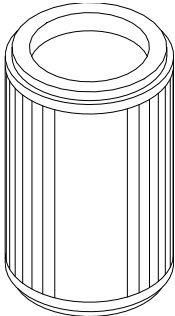
Disegno Drawing Dessin Zeichnung	N° catalogo Part number N° Catalogue Katalog Nr	Superficie filtrante Filtering surface Surface filtrante Filterfläche [cm²]	Per filtri Suitable for filter Pour filtre Für Filter	Confezione n° pz Package pcs Emballage Verpackung
	4495/C	820	4411 /C	15
	4496/C	1850	4421 /C	8

**ACCESSORI**  
**ACCESSORIES**  
**ACCESSOIRES**  
**ZUBEHÖR**

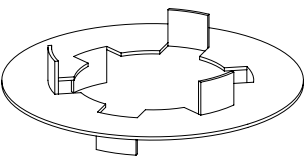
Disegno Drawing Dessin Zeichnung	N° catalogo Part number N° catalogue Katalog Nr	Componenti Parts Composant Komponenten	Per filtri Suitable for filter Pour filtre Für filter	Confezione n° pz Package pcs. Emballage Verpackung
	9900/X74	Disco centratore per due cartucce meccaniche Centering disc for two blocks Disque de centrage pour deux cartouches Zentrierscheibe für zwei Filtereinsätze	4412 /_AF SF412/_A (1)	1



(1)  
sostituire componenti interni con ricambio  
9151/R02

(1)  
replace internal components with spare part  
9151 / R02

(1)  
remplacer les composants internes par la  
pièce de rechange 9151 / R02

(1)  
Ersetzen Sie die internen Komponenten  
durch das Ersatzteil 9151 / R02

**SEPARATORI D'OLIO**  
**OIL SEPARATORS**  
**SÉPARATEURS D'HUILE**  
**ÖLABSCHEIDER**

Disegno Drawing Dessin Zeichnung	N° catalogo Part number N° catalogue Katalog Nr.		Attacchi Connections Raccords Anschlüsse				N° catalogo coppia attacchi saldare (1) Part number couple of solder connections (1) N° Catalogue couple de raccords à souder (1) Katalog Nr. Schweissanschluss-Paar (1)	PS [bar]	TS [°C]		Confezione n° pz Package pcs Emballage Verpackung
			ODS		ODM				min	max	
			Ø [in.]	Ø [mm]	Ø [in.]	Ø [mm]					
	NEW	OS540/4R	1/2"	-	5/8"	16	45	-10	+130	1	
	NEW	OS540/4	1/2"	-	5/8"	16					
	NEW	OS540/5	5/8"	16	3/4"	-					
	NEW	OS540/7	7/8"	-	1"	-					
	NEW	OS540/9	1.1/8"	-	1.3/8"	35					
	NEW	OS540/11	1.3/8"	35	1.5/8"	-					
		5540/13	1.5/8"	-	-	-	32				
		5540/M42	-	42	-	-					
		5540/17	2.1/8"	54	-	-					
		5520/C	-				5590/5 - 5590/7	45	-10	+130	1
		5520/D	-				5590/9 - 5590/11				
		5520/E	-				5590/13 - 5590/M42				

(1)  
Da ordinare separatamente

(1)  
To be ordered separately

(1)  
Doit être commandé séparément

(1)  
Sind separat zu bestellen

**COPPIE DI ATTACCHI PER SEPARATORI D'OLIO 5520**  
**COUPLE OF CONNECTIONS FOR OIL SEPARATORS 5520**  
**COUPLE DE CONNECTIONS POUR SÉPARATEURS D'HUILE 5520**  
**LÖTFITTING-PAAR FÜR ÖLABSCHEIDER 5520**

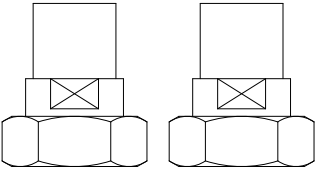
Disegno Drawing Dessin Zeichnung	N° catalogo Part number N° catalogue Katalog Nr.	Attacchi saldare Solder connections Raccords à souder Schweiss-anschlüsse ODS		Guarnizione Gasket Dichtung Joint (1)	PS [bar]	TS [°C]		Confezione n° pz Package pcs Emballage Verpackung
		Ø [in.]	Ø [mm]			min	max	
	5590/5	5/8"	16	003879	45	-10	+130	1
	5590/7	7/8"	-					
	5590/9	1.1/8"	-					
	5590/11	1.3/8"	35	003870				
	5590/13	1.5/8"	-	003965				
	5590/M42	-	42					

(1)  
Da ordinare separatamente

(1)  
To be ordered separately

(1)  
Doit être commandé séparément

(1)  
Sind separat zu bestellen

**RUBINETTI PER SISTEMI FRIGORIFERI ERMETICI**  
**VALVES FOR HERMETIC SYSTEMS**  
**VANNES POUR INSTALLATIONS DE GROUPES HERMÉTIQUES**  
**KLEINVENTILE FÜR HERMETISCHE KÄLTEANLAGEN**

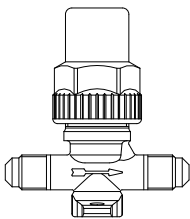
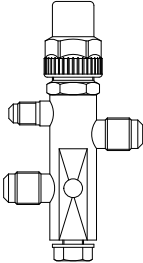
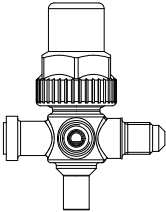
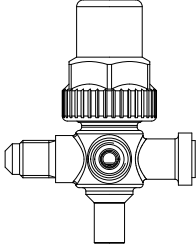
Disegno Drawing Dessin Zeichnung	N° catalogo Part number N° catalogue Katalog Nr.	Att. Carica Access fitting Raccord chargement Füllanschluss SAE Flare	Attacchi Connections Raccords Anschlüsse				Kv [m³/h]	PS [bar]	TS [°C]		Confezione n° pz Package pcs Emballage Verpackung	
			SAE Flare		ODS				min	max		
					Ø [in.]	Ø [mm]						
	6010/2	-	1/4"	1/4"	-	-	0,27	45	-40	+130	45	
	6012/22		1/4"	-	1/4"	-					72	
	6020/222	1/4"	1/4"	1/4"	-	-	0,39	45	-40	+110	40	
	6020/233		3/8"	3/8"	-	-						1,2
	6020/244		1/2"	1/2"	-	-						2,2
	6020/255		5/8"	5/8"	-	-						2,8
	6062/22M6	1/4"	1/4"	-	-	6	0,46	45	-40	+110	48	
	6062/23M10		3/8"	-	-	10						1,38
	6072/22M6	1/4"	1/4"	-	-	6	0,46	45	-40	+110	48	
	6072/23M8		3/8"	-	-	8						1,29
	6072/23M10		3/8"	-	-	10						1,38
	6072/24M12		1/2"	-	-	12						2,55
	6072/25M16		5/8"	-	-	16					3,4	36

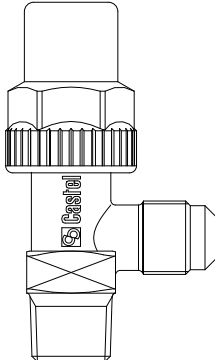
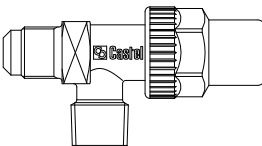
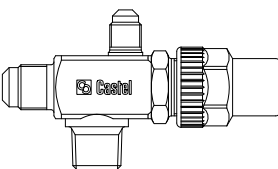
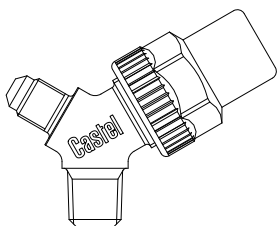

**RUBINETTI PER SERBATOIO**  
**RECEIVER VALVES**  
**VANNES POUR RÉSERVOIR**  
**SAMMLER VENTILE**

Disegno Drawing Dessin Zeichnung	N° catalogo Part number N° catalogue Katalog Nr.	Att. Carica Acces fitting Raccord chargement Füllanschluss SAE Flare	Attacchi Connections Raccords Anschlüsse		Kv [m³/h]	PS [bar]	TS [°C]		Confezione n° pz Package pcs Emballage Verpackung
			SAE Flare	NPT			min	max	
	6110/21	-	1/4"	1/8"	0,44	45	-40	+130	90
	6110/22		1/4"	1/4"	0,44				
	6110/X11		-	1/4" M/F	0,44				
	6110/X15	1/4" f	1/4"	-	0,44				
	6110/23	-	1/4"	3/8"	0,45				
	6110/32		3/8"	1/4"	1,35				
	6110/33		3/8"	3/8"	1,35				
	6110/X13	3/8" f	3/8"	-	1,35				
	6110/43	-	1/2"	3/8"	2,4				
	6110/44		1/2"	1/2"	3,4				
	6110/54		5/8"	1/2"	3,4				
	6110/66		3/4"	3/4"	6				24
	6120/22	-	1/4"	1/4"	0,44	45	-40	+130	90
	6120/23		1/4"	3/8"	0,45				
	6120/32		3/8"	1/4"	1,35				
	6120/33		3/8"	3/8"	1,35				
	6120/43		1/2"	3/8"	2,4				
	6120/44		1/2"	1/2"	3,4				
	6120/54		5/8"	1/2"	3,4				
	6120/66		3/4"	3/4"	6				24
	6132/22	1/4"	1/4"	1/4"	0,45	45	-40	+110	90
	6132/33		3/8"	3/8"	1,2				40
	6132/44		1/2"	1/2"	2,2				
	6132/54		5/8"	1/2"	3,85				
	6140/22	-	1/4"	1/4"	0,36	45	-40	+130	90
	6140/23		1/4"	3/8"					

**RUBINETTI PER CONDIZIONATORI SPLIT**  
**STOP VALVES FOR SPLIT CONDITIONING SYSTEMS**  
**VANNES POUR CLIMATISEURS SPLIT**  
**KLEINVENTILE FÜR SPLIT - KLIMAANLAGEN**

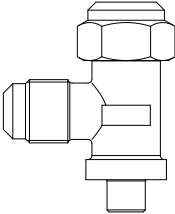
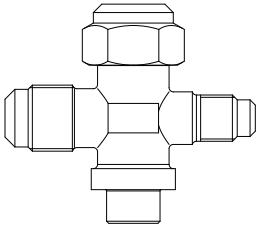
Disegno Drawing Dessin Zeichnung	N° catalogo Part number N° catalogue Katalog Nr.	Att. Carica Acces fitting Raccord chargement Füllanschluss SAE Flare	Attacchi Connections Raccords Anschlüsse			Kv [m³/h]	PS [bar]	TS [°C]		Confezione n° pz Package pcs Emballage Verpackung
			SAE Flare	ODS				min	max	
				Ø [in.]	Ø [mm]					
	6165/22	-	1/4"	1/4"	-	0,68	45	-20	+110	24
	6165/33		3/8"	3/8"	-	1,7				
	6175/33	1/4"	3/8"	3/8"	-	1,7	45	-20	+110	18
	6175/44		1/2"	1/2"	-	3,4				
	6175/55		5/8"	5/8"	16	4,6				
	6170/66		3/4"	3/4"	-	9				
	6170/77		7/8"	7/8"	-	10,8				
	6176/44	1/2"	1/2"	-	3,4	45	-20	+110	14	
	6176/55	5/8"	5/8"	16	4,6					
	6176/66	3/4"	3/4"	-	7,5					

**RUBINETTI A MEMBRANA**  
**DIAPHRAGM VALVES**  
**VANNES A MEMBRANE**  
**MEMBRANVENTILE**

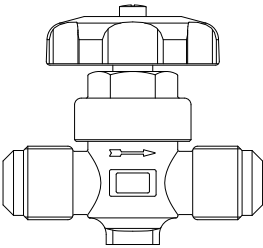
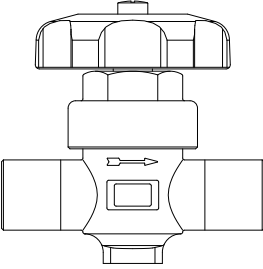
Disegno Drawing Dessin Zeichnung	N° catalogo Part number N° catalogue Katalog Nr.	Attacchi Connections Raccords Anschlüsse			Kv [m³/h]	PS [bar]	TS [°C]		Confezione n° pz Package pcs Emballage Verpackung
		SAE Flare	ODS				min	max	
			Ø [in.]	Ø [mm]					
	6210/2	1/4"	-	-	0,28	28	-35	+90	45
	6210/3	3/8"			1				
	6210/4	1/2"			1,3				
	6210/5	5/8"			1,8				
	6210/6	3/4"			3,65				
	6210/6	3/4"			14				
	6220/M6	-	6	0,28	28	-35	+90	45	
	6220/2	1/4"	-	0,28					
	6220/3	3/8"	-	1					
	6220/M10	-	10	1					
	6220/4	1/2"	-	1,3					
	6220/5	5/8"	16	1,8					
	6220/6	3/4"	-	3,65					
	6220/7	7/8"	-	3,65					
6220/7	7/8"	14							

**RUBINETTI A CAPPELLOTTA**  
**CAPPED VALVES**  
**VANNES A CAPUCHON**  
**KAPPENVENTILE**

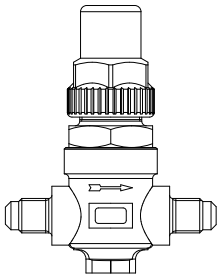
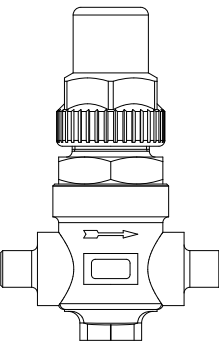
Disegno Drawing Dessin Zeichnung	N° catalogo Part number N° catalogue Katalog Nr.	Attacchi Connections Raccords Anschlüsse			Kv [m³/h]	PS [bar]	TS [°C]		Confezione n° pz Package pcs Emballage Verpackung
		SAE Flare	ODS				min	max	
			Ø [in.]	Ø [mm]					
	6410/2	1/4"			0,4	45	-40	+110	45
	6410/3	3/8"			1				
	6410/4	1/2"	-	-	1,45				
	6410/5	5/8"			1,7				
	6410/6	3/4"			3,5				14
	6420/2	-	1/4"	-	0,4	45	-40	+110	45
	6420/3	-	3/8"	-	1				
	6420/3S3	3/8" - OUT	3/8" - IN	-	1				
	6420/M10	-	-	10	1				
	6420/M12	-	-	12	1,45				
	6420/4	-	1/2"	-	1,45				
	6420/5	-	5/8"	16	1,7				
	6420/M18	-	-	18	3,5				
	6420/6	-	3/4"	-	3,5				14
	6420/M22	-	-	22	3,5				
	6420/7	-	7/8"	-	3,5				

**RUBINETTI A SFERA - OMOLOGATI DA UNDERWRITERS LABORATORIES INC.**  
**BALL VALVES - APPROVED BY UNDERWRITERS LABORATORIES INC.**  
**VANNES A BOISSEAU SPHÉRIQUE - HOMOLOGUÉS PAR UNDERWRITERS LABORATORIES INC.**  
**KUGELABSPERRVENTILE - ZUGELASSEN VON UNDERWRITERS LABORATORIES INC.**

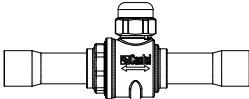
Disegno Drawing Dessin Zeichnung	N° catalogo Part number N° catalogue Katalog Nr.	Attacchi Connections Raccords Anschlüsse		Foro Sfera Ø Ball port Ø Orifice bille Ø Bohrung Ø [mm]	Kv [m³/h]	PS [bar]	TS [°C]		Confezione n° pz Package pcs Emballage Verpackung			
		ODS					min	max				
		Ø [in.]	Ø [mm]									
	6570/M6	-	6	10	0,8	45 (1)	-40	+150	25			
	6570/2	1/4"	-		3							
	6570/3	3/8"	-							5		
	6570/M10	-	10		15						17	16
	6570/M12	-	12									
	6570/4	1/2"	-									
	6571/5	5/8"	16									
	6570/M15	-	15	19					29	21		
	6570/5	5/8"	16									
	6570/M18	-	18									
	6570/6	3/4"	-		25						51	16
	6571/7	7/8"	22									
	6570/7	7/8"	22	32					86	6		
	6571/M28	-	28									
	6571/9	1.1/8"	-		40						117	6
	6570/M28	-	28									
	6570/9	1.1/8"	-	50					217	1		
	6571/11	1.3/8"	35									
	6570/11	1.3/8"	35		60						380	45
	6571/13	1.5/8"	-									
	6571/M42	-	42	64	64				64	64	64	64
	6570/13	1.5/8"	-									
	6570/M42	-	42	64	64				64	64	64	64
	6571/17	2.1/8"	54									
	6570/17	2.1/8"	54	64	64				64	64	64	64
6571/M64	-	64										
6571/21	2.5/8"	-	64	64	64	64	64	64				
6570/M64 (2)	-	64										

(1)  
MWP = 500 psi per 6570/.. e 6590/..  
- MWP = 435 psi per 6571/.. e 6591/..  
in conformità a omologazione UL

(2)  
non omologato UL

Rubinetti 6590/..; 6591/.. in esaurimento  
scorte

(1)  
MWP = 500 psi for 6570/.. and 6590/..  
- MWP = 435 psi for 6571/.. and 6591/..  
according to UL approval

(2)  
not UL approved

Valves 6590/..; 6591/.. running out of  
stock

(1)  
MWP = 500 psi pour 6570/.. et 6590/..  
- MWP = 435 psi pour 6571/.. et 6591/..  
conformément à homologation UL

(2)  
Pas approuvé UL

Vannes 6590/..; 6591/.. en épuisement  
du stock

(1)  
MWP = 500 psi für 6570/.. und 6590/..  
- MWP = 435 psi für 6571/.. und 6591/..  
in Übereinstimmung zur UL-Zulassung

(2)  
Ohne UL-Zertifizierung

Ventile 6590/..; 6591/.. bis zum Ende der  
Vorräte erhältlich

**RUBINETTI A SFERA CON ATTACCO DI CARICA - OMOLOGATI DA UNDERWRITERS LABORATORIES INC.**  
**BALL VALVES WITH ACCESS FITTING - APPROVED BY UNDERWRITERS LABORATORIES INC.**  
**VANNES A BOISSEAU SPHÉRIQUE AVEC RACCORD DE CHARGE - HOMOLOGUÉS PAR UNDERWRITERS LABORATORIES INC.**  
**KUGELABSPERRVENTILE MIT SCHRADER - ZUGELASSEN VON UNDERWRITERS LABORATORIES INC.**

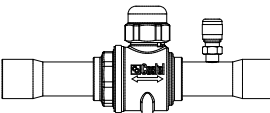
Disegno Drawing Dessin Zeichnung	N° catalogo Part number N° catalogue Katalog Nr.	Attacchi Connections Raccords Anschlüsse		Foro Sfera Ø Ball port Ø Orifice bille Ø Bohrung Ø [mm]	Kv [m <sup>3</sup> /h]	PS [bar]	TS [°C]		Confezione n° pz Package pcs Emballage Verpackung
		ODS					min	max	
		Ø [in.]	Ø [mm]						
	6570/M6A	-	6	10	0,8	45 (1)	-40	+150	25
	6570/2A	1/4"	-		3				
	6570/3A	3/8"	-						
	6570/M10A	-	10		5				
	6570/M12A	-	12						
	6570/4A	1/2"	-		15				
	6570/M15A	-	15						
	6570/5A	5/8"	16						
	6570/M18A	-	18	19	29				
	6570/6A	3/4"	-						
	6570/7A	7/8"	22	25	51				
	6570/M28A	-	28						
	6570/9A	1.1/8"	-	32	86				
	6570/11A	1.3/8"	35						
	6570/13A	1.5/8"	-	40	117				
	6570/M42A	-	42						
	6570/17A	2.1/8"	54	50	214				
	6571/M64A	-	64						
	6571/21A	2.5/8"	-	60	380				
	6570/M64A (2)	-	64						
	6570/21A (2)	2.5/8"	-						
	6571/24A (2)	3"	76	73	550				
	6571/25A (2)	3.1/8"	80						
	6570/24A (2)	3"	76	82	710				
	6570/25A (2)	3.1/8"	80						
	6571/28A (2)	3.1/2"	89	82	660				
	6571/29A (2)	3.5/8"	92						
	6570/28A (2)	3.1/2"	89	82	660				
	6570/29A (2)	3.5/8"	92						
	6571/33A (2)	4.1/8"	105	82	660				
6571/34A (2)	4.1/4"	108							

(1)  
MWP = 500 psi per 6570/.. e 6590/..  
- MWP = 435 psi per 6571/.. e 6591/..  
in conformità a omologazione UL

(2)  
non omologato UL

Rubinetti 6590/.. in esaurimento scorte

(1)  
MWP = 500 psi per 6570/.. and 6590/..  
- MWP = 435 psi for 6571/.. and 6591/..  
according to UL approval

(2)  
not UL approved

Valves 6590/.. running out of stock

(1)  
MWP = 500 psi pour 6570/.. et 6590/..  
- MWP = 435 psi pour 6571/.. et 6591/..  
conformément à homologation UL

(2)  
Pas approuvé UL

Vannes 6590/.. en épuisement du stock

(1)  
MWP = 500 psi für 6570/.. und 6590/..  
- MWP = 435 psi für 6571/.. und 6591/..  
in Übereinstimmung zur UL-Zulassung

(2)  
Ohne UL-Zertifizierung

Ventile 6590/.. bis zum Ende der Vorräte erhältlich

**RUBINETTI A 3-VIE MANUALI**  
**3-WAY MANUAL VALVES**  
**VANNES MANUELLES À 3 VOIES**  
**3-WEGE-HANDVENTILE**

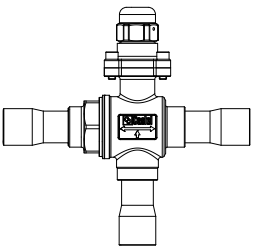
Disegno Drawing Dessin Zeichnung	N° catalogo Part number N° Catalogue Katalog Nr	Attacchi Connections Raccords Anschlüsse		Foro Sfera Ø Ball port Ø Orifice bille Ø Bohrung Ø [mm]	Kv [m³/h]	PS [bar]	TS [°C]		Confezione n° pz Package pcs Emballage Verpackung
		ODS					min.	max.	
		Ø [in.]	Ø [mm]						
	6690/7	7/8"	22	19	10,7	45	-40	+150	1
	6690/M28	–	28	24	15,9				
	6690/9	1.1/8"	–	24	15,9				
	6690/11	1.3/8"	35	28	20,3				
	6690/13	1.5/8"	–	37	38,5				
	6690/M42	–	42	37	38,5				

**RUBINETTI A 3-VIE DA MOTORIZZARE**  
**3-WAY VALVES TO BE MOTORIZED**  
**VANNES À 3 VOIES À MOTORISER**  
**3-WEGE-VENTILE, DIE MOTORISIERT WERDEN**

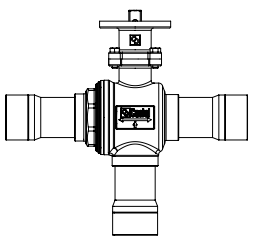
Disegno Drawing Dessin Zeichnung	N° catalogo Part number N° Catalogue Katalog Nr (1)	Attacchi Connections Raccords Anschlüsse		Foro Sfera Ø Ball port Ø Orifice bille Ø Bohrung Ø [mm]	Kv [m³/h]	PS [bar]	TS [°C]		Confezione n° pz Package pcs Emballage Verpackung
		ODS					min.	max.	
		Ø [in.]	Ø [mm]						
	6690B/7	7/8"	22	19	10,7	45	-40	+150	1
	6690B/M28	–	28	24	15,9				
	6690B/9	1.1/8"	–	24	15,9				
	6690B/11	1.3/8"	35	28	20,3				
	6690B/13	1.5/8"	–	37	38,5				
	6690B/M42	–	42	37	38,5				

(1) completo di adattatore per servomotore BELIMO

(1) with adapter for BELIMO actuator

(1) avec adaptateur pour servomoteur BELIMO

(1) mit Adapter für BELIMO-Antrieb

**RUBINETTI A 3-VIE MOTORIZZATI**  
**3-WAY MOTORIZED VALVES**  
**3-VOIES VANNES MOTORISÉ**  
**3 WEGE MOTORVENTILE**

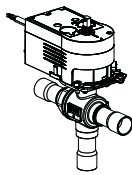
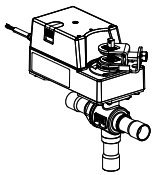

Disegno Drawing Dessin Zeichnung	N° catalogo Part number N° Catalogue Katalog Nr (1)	Attacchi Connections Raccords Anschlüsse		Coppia Torque Couple Drehmoment [Nm]	Tempo di marcia Running time Durée de course Laufzeit [sec]	Potenza Power Puissance Leistung [W]	Foro Sfera Ø Ball port Ø Orifice bille Ø Bohrung Ø [mm]	Kv [m³/h]	PS [bar]	TS [°C]		Confezione n° pz Package pcs Emballage Verpackung
		ODS								min.	max.	
		Ø [in.]	Ø [mm]									
	6690M/7A2 (2)	7/8"	22	10	60	4,8	19	10,7	45	-40	+150	1
	6690M/7A6 (3)					2,9						
	6690M/M28A2 (2)	-	28	10	60	4,8	24	15,9				
	6690M/M28A6 (3)					2,9						
	6690M/9A2 (2)	1.1/8"	-	10	60	4,8	24	15,9				
	6690M/9A6 (3)					2,9						
	6690M/11A2 (2)	1.3/8"	35	30	120	2,4	28	20,3	45	-40	+150	1
	6690M/11A6 (3)					3,7						
	6690M/13A2 (2)	1.5/8"	-	30	120	2,4	37	38,5				
	6690M/13A6 (3)					3,7						
	6690M/M42A2 (2)	-	42	30	120	2,4	37	38,5				
	6690M/M42A6 (3)					3,7						

(1) completo di attuatore e piastra di montaggio

(2)  
 - Tensione = 24 V  
 - Frequenza = 50/60 Hz  
 - Grado di protezione = IP 54  
 - Angolo di manovra = 90 °  
 - Connessioni elettriche: uscita in commutazione a 2 punti (aperto/chiuso) oppure uscita in continua (0 ÷ 10V)

(3)  
 - Tensione = 230 V  
 - Frequenza = 50/60 Hz  
 - Grado di protezione = IP 43  
 - Angolo di manovra = 90 °  
 - Connessioni elettriche: uscita in commutazione a 2 punti (aperto/chiuso)

(1) with actuator and mounting plate

(2)  
 - Voltage = 24 V  
 - Frequency = 50/60 Hz  
 - Degree of protection = IP 54  
 - Rotation angle = 90°  
 - Wiring connections : switching output 2 points (open/close) or continuous output (0 ÷ 10V)

(3)  
 - Voltage = 230 V  
 - Frequency = 50/60 Hz  
 - Degree of protection = IP 43  
 - Rotation angle = 90°  
 - Wiring connections : switching output 2 points (open/close)

(1) avec servomoteur et la plaque de montage

(2)  
 - Tension = 24 v  
 - Fréquence = 50/60 Hz  
 - Degré de protection = IP 54  
 - Angle de rotation = 90°  
 - Connexions électriques : sortie à contacts à 2 points (ouvert/fermé) ou sortie progressive (0 ÷ 10V)

(3)  
 - Tension = 230 V  
 - Fréquence = 50/60 Hz  
 - Degré de protection = IP 43  
 - Angle de rotation = 90°  
 - Connexions électriques : sortie à contacts à 2 points (ouvert/fermé)

(1) mit Stellantrieb und Montageplatte

(2)  
 - Spannung = 24 V  
 - Frequenz = 50/60 Hz  
 - Schutzgrad = IP 54  
 - Drehwinkel = 90°  
 - Anschlussplan : Schaltendem Ausgang 2 Punkt (offen/geschlossen) oder Stetigem Ausgang (0 ÷ 10V)

(3)  
 - Spannung = 230 V  
 - Frequenz = 50/60 Hz  
 - Schutzgrad = IP 43  
 - Drehwinkel = 90°  
 - Anschlussplan : Schaltendem Ausgang 2 Punkt (offen/geschlossen)

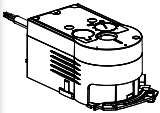
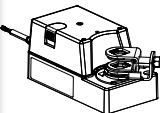
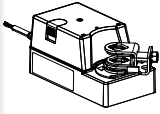
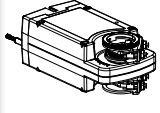
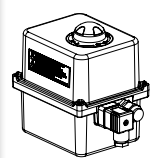
Disegno Drawing Dessin Zeichnung	N° catalogo Part number N° Catalogue Katalog Nr	Tensione Voltage Tension Spannung	Frequenza Frequency Fréquence Frequenz	Potenza Power Puissance Leistung	Grado di protezione Degree of protection Degrè de protection Schutzgrad	Adatto per rubinetto Designed for valve Adapté pour vanne Passed für ventil	Angolo di manovra Rotation angle Angle de rotation Drehwinkel	Coppia Torque Couple Drehmoment	Tempo di marcia Running time Durée de course Laufzeit	Temperatura ambiente Ambient temperature Température Umgebung- stemperatur		Confezione n° pz Package Pcs. Emballage Verpackung
		[°C]										
		[V]	[Hz]	[W]						min	Max	
	9700/RA2 (1)	24	50/60	4,8	IP 54	6570/M6; 6570/M6A; 6570/2; 6570/2A; 6570/3 6570/3A; 6570/M10; 6570/M10A; 6570/M12; 6570/M12A; 6570/4; 6570/4A; 6570/M15; 6570/M15A; 6570/5; 6570/5A; 6570/M18; 6570/M18A; 6570/6; 6570/6A; 6570/7; 6570/7A; 6570/M28; 6570/M28A; 6570/9; 6570/9A; 6571/5; 6571/7; 6571/M28; 6571/9; 6571/11	90°	10	60	-20	+50	1
	9700/RA6 (2)	230	50/60	2,9	IP 43	6570/7; 6570/7A; 6570/M28; 6570/M28A; 6570/9; 6570/9A; 6571/M28; 6571/9; 6571/11						
	9720/RA2 (1)	24	50/60	2,4	IP 54	6570/11; 6570/11A; 6570/13; 6570/13A; 6570/M42; 6570/M42A; 6571/13; 6571/M42; 6571/17	90°	30	120	-20	+50	1
	9720/RA6 (2)	230	50/60	3,7	IP 43							
	9730/RA2 (3)	24	50/60	9	IP 54	6570/17; 6570/17A; 6571/M64; 6571/M64A; 6571/21; 6571/21A	90°	60	150	-30	+50	1
	9730/RA6 (2)	230	50/60	9	IP 54							
	<b>NEW</b> 9740/RA2 (3)	24	50/60	45	IP 66	6570/M64; 6570/M64A; 6570/21A; 6570/24A; 6570/25A; 6570/28A; 6570/29A; 6571/24A; 6571/25A; 6571/28A; 6571/29A; 6571/33A; 6571/34A	90°	100	120	-10	+55	1
	<b>NEW</b> 9740/RA6 (2)	230	50/60	45	IP 66							

(1)  
Connessioni elettriche: uscita in commutazione a 2 punti (aperto/chiuso) oppure uscita in continua (0 ÷ 10V)

(2)  
Connessioni elettriche: uscita in commutazione a 2 punti (aperto/chiuso)

(3)  
Connessioni elettriche: uscita in continua (0 ÷ 10V)

(1)  
Wiring connections : switching output 2 points (open/close) or continuous output (0 ÷ 10V)

(2)  
Wiring connections : switching output 2 points (open/close)

(3)  
Wiring connections : continuous output (0 ÷ 10V)

(1)  
Connexions électriques : sortie à contacts à 2 points (ouvert/fermé) ou sortie progressive (0 ÷ 10V)

(2)  
Connexions électriques : sortie à contacts à 2 points (ouvert/fermé)

(3)  
Connexions électriques : sortie progressive (0 ÷ 10V)

(1)  
Anschlussplan : Schaltendem Ausgang 2 Punkt (offen/geschlossen) oder Stetigem Ausgang (0 ÷ 10V)

(2)  
Anschlussplan : Schaltendem Ausgang 2 Punkt (offen/geschlossen)

(3)  
Anschlussplan : Stetigem Ausgang (0 ÷ 10V)



**CONTATTI AUSILIARI  
AUXILIARY SWITCH UNITS  
UNITÉ D'INTERRUPTEURS AUXILIAIRES  
HILFSSCHALTEREINHEIT**

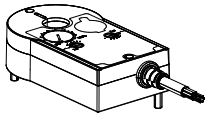
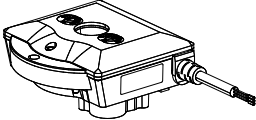

Disegno Drawing Dessin Zeichnung	N° catalogo Part number N° Catalogue Katalog Nr	Adatto per attuatore Designed for actuator Adaptéé pour servomoteur Passed für stellantrieb	Tipo contatto Contact type Type contact Kontakt Typ	Carico massimo Max loading Charge maximale Belastung [A]	Temperatura ambiente Ambient temperature Température ambiante Umgebungstemperatur [°C]		Grado di protezione Degree of protection Degrè de protection Schutzgrad	Confezione n° pz Package Pcs. Emballage Verpackung
					min	Max		
	9750/X01	9700/RA2	Doppio Double Double Dopplet	5	-20	+55	IP 40	1
	9750/X02	9700/RA6; 9720/RA2; 9720/RA6	Doppio Double Double Dopplet	5	-20	+55	IP 40	1

**ADATTATORI PER ATTUATORE  
SERVOMOTOR ADAPTERS  
ADAPTEURS POUR SERVOMOTEUR  
LOETADAPTERS FÜR STELLANTRIEB**

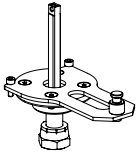
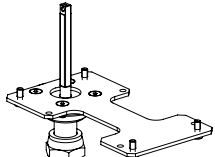
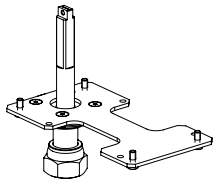
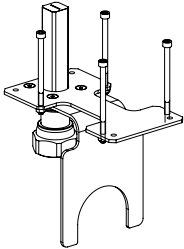
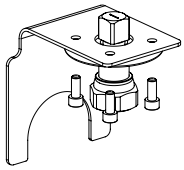
Disegno Drawing Dessin Zeichnung	N° catalogo Part number N° Catalogue Katalog Nr		Adatto per rubinetto Designed for valve Adapté pour vanne Passé für ventil	Adatto per attuatore Designed for actuator Adapté pour servomoteur Passé für stellantrieb	Confezione n° pz Package Pcs. Emballage Verpackung
	NEW	9901/X58	6570/M6; 6570/M6A; 6570/2; 6570/2A; 6570/3; 6570/3A; 6570/M10; 6570/M10A; 6570/M12; 6570/M12A; 6570/4; 6570/4A; 6570/M15; 6570/M15A; 6570/5; 6570/5A; 6570/M18; 6570/M18A; 6570/6; 6570/6A; 6571/5; 6571/7	9700/RA2	1
	NEW	9901/X60	6570/7; 6570/7A; 6570/M28; 6570/M28A; 6570/9; 6570/9A; 6571/M28; 6571/9; 6571/11		
	NEW	9901/X57	6570/7; 6570/7A; 6570/M28; 6570/M28A; 6570/9; 6570/9A; 6571/M28; 6571/9; 6571/11	9700/RA6	1
	NEW	9901/X75	6570/11; 6570/11A; 6570/13; 6570/13A; 6570/M42; 6570/M42A; 6571/13; 6571/M42; 6571/17	9720/RA2 - 9720/RA6	1
	NEW	9901/X76	6570/17; 6570/17A; 6571/M64; 6571/M64A; 6571/21; 6571/21A	9730/RA2 - 9730/RA6	1
	NEW	9901/X70	6570/M64; 6570/M64A; 6570/21A; 6571/24A; 6571/25A	9740/RA2 - 9740/RA6	1
	NEW	9901/X71	6570/24A; 6570/25A; 6571/28A; 6571/29A		
	NEW	9901/X72	6570/28A; 6570/29A; 6571/33A; 6571/34A		

**ANTIVIBRANTI, ATTACCHI DI RAME**  
**VIBRATION ABSORBERS, COPPER CONNECTIONS**  
**ÉLIMINATEURS DE VIBRATIONS, CONNEXIONS DE CUIVRE**  
**SCHWINGUNGSDÄMPFER, KUPFERANSCHLÜSSE**

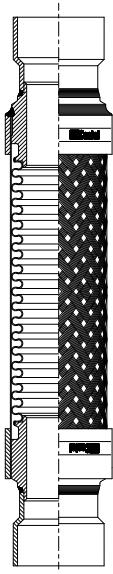
Disegno Drawing Dessin Zeichnung	N° catalogo Part number N° Catalogue Katalog Nr	Attacchi Connections Raccords Anschlüsse		PS [bar]			Confezione n° pezzi Package pcs Emballage Verpackung
		ODS		TS [°C] -80 / +100	TS [°C] +120	TS [°C] +140	
		Ø [in.]	Ø [mm]				
	7690/3	3/8"	-	45	44	43,5	100
	7690/M10	-	10				
	7690/M12	-	12				
	7690/4	1/2"	-	45	44	43,5	50
	7690/M15	-	15				
	7690/5	5/8"	16				
	7690/M18	-	18	45	44	43,5	25
	7690/6	3/4"	-				
	7690/7	7/8"	22				
	7690/M28	-	28	45	44	43,5	10
	7690/9	1.1/8"	-				
	7690/11	1.3/8"	35				
	7690/13	1.5/8"	-	45	44	43,5	5
	7690/M42	-	42				
	7690/17	2.1/8"	54				
	7690/M64	-	-	35	34,5	34	1
	7690/21	2.5/8"	67				
	7690/24	3"	76				
	7690/25	3.1/8"	80	25	24,5	24	
	7690/28	3.1/2"	89				
7690/34	4.1/4"	108					



(#)

Per applicazioni specifiche con fluidi refrigeranti non elencati sopra, prego contattare l'Ufficio Tecnico della Castel

For specific applications with refrigerant fluids not listed above, please contact Castel Technical Department

Pour des applications spécifiques avec des fluides frigorigènes non énumérés ci-dessus, s'il vous plaît contacter le service technique de la Castel

Für spezielle Anwendungen mit Kältemitteln nicht oben aufgeführt sind, kontaktieren Sie bitte Castel Technische Abteilung

# FITTINGS



REFRIGERANTI A1 - A2L - A3, ASHRAE STANDARD 34-2019<sup>(#)</sup>  
A1 - A2L - A3 REFRIGERANTS, ASHRAE STANDARD 34-2019<sup>(#)</sup>  
RÉFRIGÉRANTS A1 - A2L - A3, ASHRAE STANDARD 34-2019<sup>(#)</sup>  
A1 - A2L - A3 KALTEMITTEL, ASHRAE STANDARD 34-2019<sup>(#)</sup>

HCFC (R22)

HFC (R134a, R32, R404A, R407C, R410A, R507)

HFO (R1234yf, R1234ze)

HFO + HFC (R448A, R449A, R450A, R452A, R452B, R454A, R454B,  
R454C, R455A, R513A)

HC (R290, R600 , R600a, R1270)

R744

**GIUNTI A FLANGIA  
FLANGE JOINTS  
JOINTS À BRIDE  
FLANSCHVERBINDUNG**

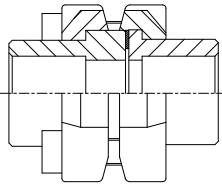
Disegno Drawing Dessin Zeichnung	N° catalogo Part number N° catalogue Katalog Nr.	Attacchi Connections Raccords Anschlüsse		PS [bar]	Confezione n° pz Package pcs Emballage Verpackung
		ODS			
		Ø [in.]	Ø [mm]		
	7630/7	7/8"	-	45	18
	7630/9	1.1/8"	-		
	7630/11	1.3/8"	35		14
	7630/13	1.5/8"	-		
	7630/M42	-	42		
	7630/17	2.1/8"	54		

**GUARNIZIONI PER GIUNTI A FLANGIA  
GASKETS FOR FLANGE JOINTS  
JOINTS POUR BRIDES D'ACCOUPEMENT  
DICHTUNG FÜR FLANSCHVERBINDUNG**

Disegno Drawing Dessin Zeichnung	N° catalogo Part number N° catalogue Katalog Nr.	x Giunto a flangia x Flange joint x Bride d'accouplement x Flanschverbindung	Confezione n° pz Package pcs Emballage Verpackung
	000581	7630/7; 7630/9	10
	000618	7630/11	
	000624	7630/13; 7630/M42	
	000630	7630/17	

**RACCORDI D'OTTONE FILETTATI**  
**THREADED BRASS FITTINGS**  
**RACCORDS FILETES EN LAITON**  
**MESSINGFITTINGE**

Disegno Drawing Dessin Zeichnung	N° catalogo Part number N° catalogue Katalog Nr.	Codice internazionale International code Code international Internationaler Code	SAE Flare	Tubo di rame Copper Pipe Tuyau en cuivre Kupferrohr		PS [bar]	Confezione n° pz Package pcs Emballage Verpackung
				Ø [in.]	Ø [mm]		

Bocchettoni sae flare per tubi in pollici / sae flare nuts for inch tubing / raccords sae flare pour tuyaux en pouces / bördelmutter für zollrohr

	7010/22	NS4-4	1/4"	1/4"	6	50	100
	7010/33	NS4-6	3/8"	3/8"	-		50
	7010/44	NS4-8	1/2"	1/2"	-		25
	7010/55	NS4-10	5/8"	5/8"	16		10
	7010/66	NS4-12	3/4"	3/4"	-		1
	7010/77	NS4-14	7/8"	7/8"	22		
	7010/88	NS4-16	1"	1"	-		

Bocchettoni sae flare ciechi / sae flare cap nuts / raccords sae flare borgne / blindhutmutter

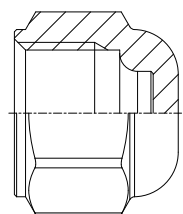
	7020/20	N5-4 CAP NUT	1/4"	-	-	140	100
	7020/X02	N5-5 CAP NUT	5/16"	-	-		50
	7020/30	N5-6 CAP NUT	3/8"	-	-		
	7020/40	N5-8 CAP NUT	1/2"	-	-		



**RACCORDI D'OTTONE FILETTATI**  
**THREADED BRASS FITTINGS**  
**RACCORDS FILETES EN LAITON**  
**MESSINGFITTINGE**

Disegno Drawing Dessin Zeichnung	N° catalogo Part number N° catalogue Katalog Nr.	Codice internazionale International code Code international Internationaler Code	SAE Flare	Tubo di rame Copper Pipe Tuyau en cuivre Kupferrohr		PS [bar]	Confezione n° pz Package pcs Emballage Verpackung
				Ø [in.]	Ø [mm]		

Bocchettoni sae flare ridotti per tubi in pollici / sae flare reducing nuts for inch tubing / raccords sae flare réduits pour tuyaux en pouces / Reduzierbördelmutter für Zollrohr

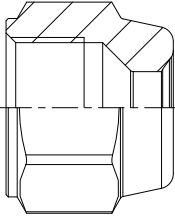
	7020/32	NRS4-64	3/8"	1/4"	6	50	50
	7020/43	NRS4-86	1/2"	3/8"	-		
	7020/54	NRS4-108	5/8"	1/2"	-		25
	7020/65	NRS4-1210	3/4"	5/8"	16		
	7020/87	NRS4-1614	1"	7/8"	22		

Bocchettoni sae flare per tubi in millimetri / sae flare nuts for metric tubing / raccords sae flare pour tuyaux en millimètres / Bördelmutter für Rohre in millimeter

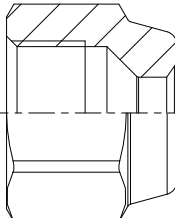
	7030/2M5	-	1/4"	-	5	50	100
	7030/3M8	-	3/8"	-	8		
	7030/3M10	-	3/8"	-	10		
	7030/4M10	-	1/2"	-	10		
	7030/4M12	-	1/2"	-	12		
	7030/X04 (1)	-	1/2"	-	12		25
	7030/4M14	-	1/2"	-	14		
	7030/5M12	-	5/8"	-	12		
	7030/5M14	-	5/8"	-	14		
	7030/6M14	-	3/4"	-	14		
	7030/6M18	-	3/4"	-	18		

(1)  
ribassato

(1)  
shortened length

(1)  
réduit

(1)  
Reduzierung

Manicotti girevoli / sae flare twin nuts / manchons pivotants / doppelmutter

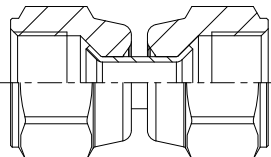
	7050/2	US4-4	1/4"	-	-	50	50
	7050/3	US4-6	3/8"	-	-		
	7050/4	US4-8	1/2"	-	-		25
	7050/5	US4-10	5/8"	-	-		

**RACCORDI D'OTTONE FILETTATI**  
**THREADED BRASS FITTINGS**  
**RACCORDS FILETES EN LAITON**  
**MESSINGFITTINGE**

Disegno Drawing Dessin Zeichnung	N° catalogo Part number N° catalogue Katalog Nr.	Codice internazionale International code Code international Internationaler Code	Attacchi Connections Raccords Anschlüsse		PS [bar]	Confezione n° pz Package pcs Emballage Verpackung
			SAE Flare	NPT		

**Giunti sae flare / sae flare unions / joints sae flare / doppelnippel**

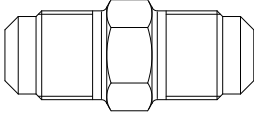
	7110/2	U2-4	1/4"	-	140	100
	7110/3	U2-6	3/8"	-		
	7110/4	U2-8	1/2"	-		50
	7110/5	U2-10	5/8"	-		
	7110/6	U2-12	3/4"	-		10
	7110/8	U2-16	1"	-		

**Giunti sae flare ridotti / reducing sae flare unions / joints sae flare réduits / reduziernippel**

	7120/23	UR2-64	1/4" x 3/8"	-	140	25
	7120/24	UR2-84	1/4" x 1/2"	-		
	7120/34	UR2-86	3/8" x 1/2"	-		
	7120/35	UR2-106	3/8" x 5/8"	-		
	7120/45	UR2-108	1/2" x 5/8"	-		
	7120/46	UR2-128	1/2" x 3/4"	-		10
	7120/56	UR2-1210	5/8" x 3/4"	-		

**Giunti sae flare - NPT / sae flare - NPT unions / joints sae flare - NPT / sae bördel - NPT nippel**

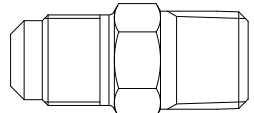
	7130/2	U1-4B	1/4"	1/4"	120	100
	7130/3	U1-6C	3/8"	3/8"		
	7130/4	U1-8D	1/2"	1/2"		50
	7130/6	U1-12F	3/4"	3/4"		
	7130/8	U1-16H	1"	1"		10

**Giunti sae flare - NPT ridotto / sae flare - NPT reducing unions / joints sae flare - NPT réduit / sae bördel - NPT reduziernippel**

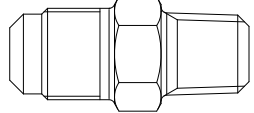
	7140/21	U1-4A	1/4"	1/8"	120	100
	7140/32	U1-6B	3/8"	1/4"		
	7140/34	U1-6D	3/8"	1/2"		50
	7140/43	U1-8C	1/2"	3/8"		
	7140/54	U1-10D	5/8"	1/2"		25

**RACCORDI D'OTTONE FILETTATI**  
**THREADED BRASS FITTINGS**  
**RACCORDS FILETES EN LAITON**  
**MESSINGFITTINGE**

Disegno Drawing Dessin Zeichnung	N° catalogo Part number N° catalogue Katalog Nr.	Codice internazionale International code Code international Internationaler Code	Attacchi Connections Raccords Anschlüsse						PS [bar]	Confezione n° pz Package pcs Emballage Verpackung
			SAE Flare		NPT	GAS	ODS			
			M	F			Ø [in.]	Ø [mm]		

Riduzione maschio - femmina (femmina ridotta) / male - female reducing unions (reduced female) / réduction mâle - femelle (femelle réduite) /  
 Reduziernippel innen-aussen (innengewinde reduziert)

	7150/21	U3-4A	1/4"	-	1/8" f	-	-	-	140	50
	7150/32	UR3-46	3/8"	1/4"	-	-	-	-		25
	7150/42	UR3-48	1/2"	1/4"	-	-	-	-		50
	7150/43	UR3-68	1/2"	3/8"	-	-	-	-		25
	7150/54	UR3-810	5/8"	1/2"	-	-	-	-		10
	7150/64	UR3-812	3/4"	1/2"	-	-	-	-		
	7150/65	UR3-1012	3/4"	5/8"	-	-	-	-		

Riduzione maschio - femmina (maschio ridotto) / male - female reducing unions (reduced male) / réduction mâle - femelle (male réduite) /  
 Reduziernippel innen-aussen (aussengewinde reduziert)

	7150/X29	-	-	1/4"	1/8"	-	-	-	140	25
	7150/X27	-	-	1/4"	1/4"	-	-	-		
	7150/23	UR3-64	1/4"	3/8"	-	-	-	-		
	7150/24	UR3-84	1/4"	1/2"	-	-	-	-		
	7150/34	UR3-86	3/8"	1/2"	-	-	-	-		
	7150/45	UR3-108	1/2"	5/8"	-	-	-	-		
	7150/46	UR3-128	1/2"	3/4"	-	-	-	-		
	7150/56	UR3-1210	5/8"	3/4"	-	-	-	-		10

Riduzione per bombole freon / cylinder adaptors / réductions pour bouteilles de fréon / kaeltemittel flaschenanschlussstück

	7154/2	-	1/4"	20-14 filetti sx. femmina 20-14 left thread, female 20-14 filets gauche femelle 20-14 Innengewinde LI				140	25
	7156/2	-	1/4"	W 21,8 - 14 filetti dx. femmina W 21,8-14 right thread, female W 21,8-14 filets droite femelle W 21,8-14 Innengewinde RE				140	

Prolunghe maschio - femmina / male - female unions / rallonges mâle - femelle / verlängerungsstücke aussengewinde - innengewinde

	7160/2	-	1/4"	1/4"	-	-	-	-	140	10
	7160/3	-	3/8"	3/8"	-	-	-	-		
	7160/4	-	1/2"	1/2"	-	-	-	-		

Prolunghe di conversione / unions sae flare to bsp / rallonges de conversion / umkehrverlängerungsstücke

	7164/2	-	1/4"	-	-	G1/4" f	-	-	140	100
	7166/2	-	-	1/4"	-	G1/4"m	-	-		25

**RACCORDI D'OTTONE FILETTATI**  
**THREADED BRASS FITTINGS**  
**RACCORDS FILETES EN LAITON**  
**MESSINGFITTINGE**

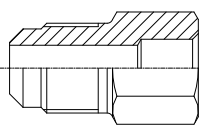

Disegno Drawing Dessin Zeichnung	N° catalogo Part number N° catalogue Katalog Nr.	Codice internazionale International code Code international Internationaler Code	Attacchi Connections Raccords Anschlüsse						PS [bar]	Confezione n° pz Package pcs Emballage Verpackung
			SAE Flare		NPT	GAS	ODS			
			M	F			Ø [in.]	Ø [mm]		

**Giunti a saldare / male sae flare - solder unions / joints à souder / schweisverbindungen**

	7170/22	US3-44	1/4"	-	-	-	1/4"	-	140	250
	7170/2M8	-	1/4"	-	-	-	-	8		
	7170/33	US3-66	3/8"	-	-	-	3/8"	-		
	7170/3M8	-	3/8"	-	-	-	-	8		25
	7170/3M10	-	3/8"	-	-	-	-	10		
	7170/34	-	3/8"	-	-	-	1/2"	-		100
	7170/44	US3-88	1/2"	-	-	-	1/2"	-		
	7170/4M12	-	1/2"	-	-	-	-	12		50
	7170/55	US3-1010	5/8"	-	-	-	5/8"	16		
	7170/6M18	-	3/4"	-	-	-	-	18		10
	7170/65	-	3/4"	-	-	-	5/8"	16		
	7170/87	-	1"	-	-	-	7/8"	22		

Disegno Drawing Dessin Zeichnung	N° catalogo Part number N° catalogue Katalog Nr.	Posizione componente Item position Position composant Position Komponente	Attacchi Connections Raccords Anschlüsse			PS [bar]	Confezione n° pz Package pcs Emballage Verpackung
			SAE Flare	ODS			
				Ø [in.]	Ø [mm]		

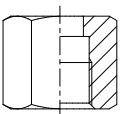
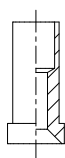
**Adattatori flare - ods / flare - ods adapters / adapteurs flare - ods / lötdapter bördel - ods**

	9901/X11	1 + 2 + 3	1/4"	-	6	140	10 + 10 + 10
	9901/X12	1 + 2 + 3	3/8"	-	10		
	9901/X13	1 + 2 + 3	1/2"	-	12		
	9901/X14	1 + 2 + 3	5/8"	5/8"	16		5 + 5 + 5
	9901/X15	1 + 2 + 3	3/4"	-	18		
	9901/X16	1 + 2 + 3	1/4"	1/4"	-	140	10 + 10 + 10
	9901/X17	1 + 2 + 3	3/8"	3/8"	-		
	9901/X18	1 + 2 + 3	1/2"	1/2"	-		
	9901/X19	1 + 2 + 3	3/4"	3/4"	-		5 + 5 + 5
	9900/X58	1	1/4"	-	-		
	9900/X59	1	3/8"	-	-	140	100
	9900/X60	1	1/2"	-	-		
	9900/X61	1	5/8"	-	-		50
	9900/X68	1	3/4"	-	-		

**RACCORDI D'OTTONE FILETTATI**  
**THREADED BRASS FITTINGS**  
**RACCORDS FILETES EN LAITON**  
**MESSINGFITTINGE**

Disegno Drawing Dessin Zeichnung	N° catalogo Part number N° catalogue Katalog Nr.	Codice internazionale International code Code international Internationaler Code	Attacchi Connections Raccords Anschlüsse			PS [bar]	Confezione n° pz Package pcs Emballage Verpackung
			SAE Flare		NPT		
			M	F			

Angoli sae flare / sae flare elbows / angles sae flare / winkelstücke sae bördel

	7210/2	E2-4	1/4"	-	-	140	100
	7210/3	E2-6	3/8"	-	-		50
	7210/4	E2-8	1/2"	-	-		25
	7210/5	E2-10	5/8"	-	-		10
	7210/6	E2-12	3/4"	-	-		

Angoli sae flare - NPT / sae flare - NPT elbows / angles sae flare - NPT / winkelstücke sae bördel - NPT

	7220/2	E1-4B	1/4"	-	1/4"	120	100
	7220/3	E1-6C	3/8"	-	3/8"		50
	7220/4	E1-8D	1/2"	-	1/2"		25
	7220/6	E1-12F	3/4"	-	3/4"		10

Angoli sae flare - NPT ridotto / sae flare - reduced NPT elbows / angles sae flare - NPT réduit / winkelstücke sae bördel - NPT reduziert

	7230/21	E1-4A	1/4"	-	1/8"	120	100
	7230/32	E1-6B	3/8"	-	1/4"		50
	7230/43	E1-8C	1/2"	-	3/8"		25
	7230/54	E1-10D	5/8"	-	1/2"		

Angoli sae flare maschio - femmina / male - female sae flare elbows / angles sae flare mâle - femelle / Winkelstücke sae bördel aussengewinde - innengewinde

	7240/2	-	1/4"	1/4"	-	140	50
	7240/3	-	3/8"	3/8"	-		25
	7240/4	-	1/2"	1/2"	-		10

**RACCORDI D'OTTONE FILETTATI**  
**THREADED BRASS FITTINGS**  
**RACCORDS FILETES EN LAITON**  
**MESSINGFITTINGE**

Disegno Drawing Dessin Zeichnung	N° catalogo Part number N° catalogue Katalog Nr.	Codice internazionale International code Code International Internationaler Code	Attacchi Connections Raccords Anschlüsse					PS [bar]	Confezione n° pz Package pcs Emballage Verpackung
			SAE Flare				NPT		
			(1)	(2)	(3)	(4)			

**Tee sae flare / sae flare tee / tee sae flare / t-stück bördel**

	7310/2	T2-4	1/4"	1/4"	1/4"	-	-	140	50
	7310/3	T2-6	3/8"	3/8"	3/8"	-	-		
	7310/4	T2-8	1/2"	1/2"	1/2"	-	-		25
	7310/5	T2-10	5/8"	5/8"	5/8"	-	-		
	7310/6	T2-12	3/4"	3/4"	3/4"	-	-		10

**Tee sae flare ridotti (attacchi laterali ridotti) / sae flare reducing tee (reduced side connections) / tee sae flare réduits (embouts latéraux réduits) / Reduzierte t-stück bördel (reduzierte seitenanschlüsse)**

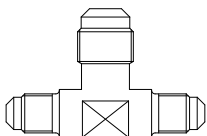
	7320/223	TR2-46	1/4"	1/4"	3/8"	-	-	140	25
	7320/334	TR2-68	3/8"	3/8"	1/2"	-	-		
	7320/445	TR2-810	1/2"	1/2"	5/8"	-	-		10
	7320/556	TR2-1012	5/8"	5/8"	3/4"	-	-		

**Tee sae flare ridotti (attacco centrale ridotto) / sae flare reducing tee (reduced central connection) / tee sae flare réduits (embouts central réduits) / Reduziertes t-stück bördel (reduzierter mittelanschluss)**

	7320/332	TR2-64	3/8"	3/8"	1/4"	-	-	140	25
	7320/443	TR2-86	1/2"	1/2"	3/8"	-	-		
	7320/554	TR2-108	5/8"	5/8"	1/2"	-	-		10
	7320/665	TR2-1210	3/4"	3/4"	5/8"	-	-		

**Tee sae flare /NPT (attacco centrale conico) / sae flare - NPT tee (taper central connection) / tee sae flare - NPT (embout central conique) / T-stück bördel - NPT (konischer mittelanschluss)**

	7330/221	T1-4A	1/4"	1/4"	-	-	1/8"	120	50
	7330/222	T1-4B	1/4"	1/4"	-	-	1/4"		
	7330/332	T1-6B	3/8"	3/8"	-	-	1/4"		25

**Tee sae flare maschio / femmina (attacco centrale femmina) / male - female sae flare tee (female central connection) / Tee sae flare mâle - femelle (embout central femelle) / bördel t-stück innen-aussengewinde (mittelanschluss mit innengewinde)**

	7340/222	T6-4	1/4"	1/4"	1/4"	-	-	140	50
---	----------	------	------	------	------	---	---	-----	----

**Croce sae flare / sae flare cross / croix sae flare / kreuzstück bördel**

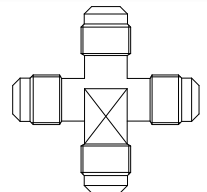
	7410/2	C1-4	1/4"	1/4"	1/4"	1/4"	-	140	50
---	--------	------	------	------	------	------	---	-----	----

**RACCORDI D'OTTONE FILETTATI**  
**THREADED BRASS FITTINGS**  
**RACCORDS FILETES EN LAITON**  
**MESSINGFITTINGE**

Disegno Drawing Dessin Zeichnung	N° catalogo Part number N° catalogue Katalog Nr.	Codice internazionale International code Code international Internationaler Code	Attacchi Connections Raccords Anschlüsse				PS [bar]	Confezione n° pz Package pcs Emballage Verpackung
			SAE Flare	NPT	ODS			
					Ø [in.]	Ø [mm]		

**Tappi sae flare / sae flare plugs / bouchon sae flare / sae flare verschlüsse**

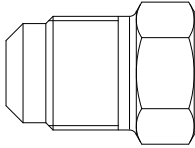
	7510/2	P2-4	1/4"	-	-	-	140	25
	7510/3	P2-6	3/8"	-	-	-		
	7510/4	P2-8	1/2"	-	-	-		10

**Tappi NPT / NPT plugs / bouchons NPT / NPT verschlüsse**

	7520/1	121-B-02	-	1/8"	-	-	120	50
	7520/2	121-B-04	-	1/4"	-	-		25
	7520/3	121-B-06	-	3/8"	-	-		10
	7520/4	121-B-08	-	1/2"	-	-		5
	7520/6	121-B-12	-	3/4"	-	-		
	7520/8	121-B-16	-	1"	-	-		

**Cappucci in rame / copper seal caps / cauchons en cuivre / kupferkappen**

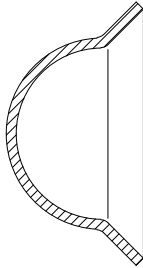
	7560/2	B1-4	1/4"	-	-	-	45	100
	7560/3	B1-6	3/8"	-	-	-		
	7560/4	B1-8	1/2"	-	-	-		
	7560/5	B1-10	5/8"	-	-	-		
	7560/6	B1-12	3/4"	-	-	-		50
	7560/7	B1-14	7/8"	-	-	-		

**Guarnizioni troncoconiche in rame / copper gaskets / garnitures troncoconiques en cuivre / kupferdichtung**

	7580/2 (1)	B2-4	1/4"	-	-	-	140	100
	7580/3 (1)	B2-6	3/8"	-	-	-		
	7580/4 (1)	B2-8	1/2"	-	-	-		
	7580/5 (1)	B2-10	5/8"	-	-	-		
	7580/6 (1)	B2-12	3/4"	-	-	-		
	7581/2 (2)	B2-4	1/4"	-	-	-		
	7581/3 (2)	B2-6	3/8"	-	-	-		
	7581/4 (2)	B2-8	1/2"	-	-	-		
	7581/5 (2)	B2-10	5/8"	-	-	-		
	7581/6 (2)	B2-12	3/4"	-	-	-		

(1) spessore nominale 1 mm

(1) nominal thickness 1 mm

(1) épaisseur nominale 1 mm

(1) Nenndicke 1 mm

(2) spessore nominale 0,5 mm

(2) nominal thickness 0,5 mm

(2) épaisseur nominale 0,5 mm

(2) Nenndicke 0,5 mm

**ATTACCHI DI CARICA**  
**ACCESS FITTINGS**  
**RACCORD D'INTERVENTION**  
**SCHRADERVENTILE**

Disegno Drawing Dessin Zeichnung	N° catalogo Part number N° catalogue Katalog Nr.	Attacchi Connections Raccords Anschlüsse									PS [bar]	Confezione n° pz Package pcs Emballage Verpackung
		SAE Flare			NPT	ODS		IDS				
		Meccanismo Valve core Mécanisme Ventileinsatz	M	F		Ø [in.]	Ø [mm]	Ø [in.]	Ø [mm]	L [mm]		

**Attacchi di carica dritti / straight access fittings / raccords de charge droits / lötschrader**

	8350/22	1/4"	-	-	-	1/4"	-	3/8"	-	-	140	100
	8350/X10	1/4"	-	-	-	1/4"	-	-	10	-		
	8350/X01	1/4"	-	-	-	-	6	-	-	-	140	100
	8350/X03	1/4"	-	-	-	-	-	-	6	90	120	100
	8350/X06	1/4"	-	-	-	-	-	1/4"	-	126		
	8350/X07	1/4"	-	-	-	-	-	1/4"	-	326		
	8530/X11	1/4"	-	-	-	-	-	-	6	130		
	8350/X12	1/4"	-	-	-	-	-	-	6	180		
	8350/X09	5/16"	-	-	-	1/4"	-	-	-	-	45	100
	8351/2	1/4"	-	-	-	-	6	-	8 10	-	140	100
	8351/X04	1/4"	-	-	-	-	-	-	6	-		
	8351/X05	5/16"	-	-	-	-	-	3/8"	7	-	140	100
	8351/X07	5/16"	-	-	-	-	-	3/8"	6	-		
	8351/X01	1/4"	-	-	-	-	1/8"	-	6	-	140	100
	8351/X02	1/4"	-	-	-	-	5	1/4" 5/16" 3/8"	-	-		
	8351/X06	1/4"	-	-	-	-	-	-	6 8 10	-		
	8352/22	1/4"	1/4"	-	-	-	-	-	-	-	140	100
	8354/21	1/4"	-	-	1/8"	-	-	-	-	-	120	100
	8354/22	1/4"	-	-	1/4"	-	-	-	-	-		
	8354/23	1/4"	-	-	3/8"	-	-	-	-	-		
	8362/22	1/4"	-	1/4"	-	-	-	-	-	-	140	10



**ATTACCHI DI CARICA**  
**ACCESS FITTINGS**  
**RACCORD D'INTERVENTION**  
**SCHRADERVENTILE**

Disegno Drawing Dessin Zeichnung	N° catalogo Part number N° catalogue Katalog Nr.	Attacchi Connections Raccords Anschlüsse					PS [bar]	Confezione n° pz Package pcs Emballage Verpackung
		SAE Flare		NPT	IDS			
		Meccanismo Valve core Mécanisme Ventileinsatz	F		Ø [in.]	Ø [mm]		

Attacchi di carica a tee / tee access fittings / raccords de chargement en tee / bördel t-stück

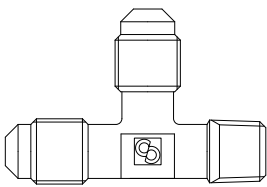
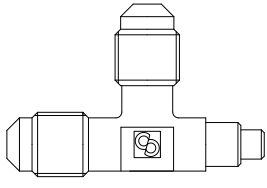
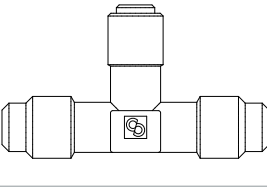
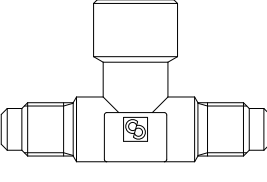
	8380/122	1/4"	-	1/8"	-	-	120	100
	8380/222	1/4"	-	1/4"	-	-		
	8380/X01	1/4"	-	-	-	6	140	100
	8380/X02	1/4"	-	-	-	7	140	100
	8380/X09	1/4"	1/4"	-	-	-	140	25

Attacchi di carica a tee con bocchettone girevole / tee access fittings with swivel nuts / raccords de charge en tee avec raccord pivotant / Bördel t-stück mit einseitiger bördelmutter

	8380/X06	1/4"	1/4"	-	-	-	45	180
	8380/X08	1/4"	1/4"	-	-	-		

**ATTACCHI DI CARICA**  
**ACCESS FITTINGS**  
**RACCORD D'INTERVENTION**  
**SCHRADERVENTILE**

Disegno Drawing Dessin Zeichnung	N° catalogo Part number N° catalogue Katalog Nr.	Attacchi Connections Raccords Anschlüsse					PS [bar]	Confezione n° pz Package pcs Emballage Verpackung
		SAE Flare		NPT	IDS			
		Meccanismo Valve core Mécanisme Ventileinsatz	F		Ø [in.]	Ø [mm]		

**Attacchi di carica a croce / cross access fittings / raccords de charge en croix / kreuzfüllanschluss**

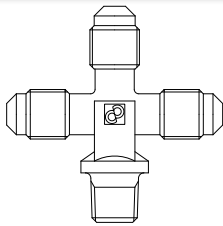
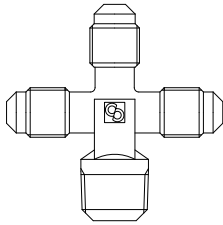
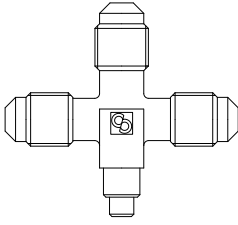
	8382/1222	1/4"	-	1/8"	-	-	120	50
	8382/X02	1/4"	-	1/4"	-	-	120	50
	8382/X01	1/4"	-	-	-	7-10	140	100
	8382/X03	1/4"	-	-	-	6		

**Attacchi di carica a croce con bocchettone girevole / cross access fittings with swivel nut / raccords de charge en croix avec raccord pivotant / kreuzfüllanschluss mit drehbarem stutzen**

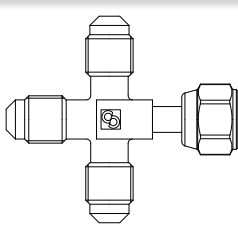
	8382/X04	1/4"	1/4"	-	-	-	45	180
---	----------	------	------	---	---	---	----	-----

**Guarnizioni di rame con codolo / copper gaskets with neck / joints en cuivre avec col / kupferdichtungen mit nacken**

	8580/2	1/4"	-	-	-	-	140	100
---	--------	------	---	---	---	---	-----	-----

**ATTACCHI DI CARICA  
ACCESS FITTINGS  
RACCORD D'INTERVENTION  
SCHRADERVENTILE**

Disegno Drawing Dessin Zeichnung	N° catalogo Part number N° catalogue Katalog Nr.	Attacchi Connections Raccords Anschlüsse		Pressione statica Static pressure Pression statique Statischer Druck [bar]	Pressione operativa Working pressure Pression fonctionnement Betriebsdruck [bar]	PS [bar]	TS [°C]		Utilizzo Use Usage Nutzung	Confezione n° pz Package pcs Emballage Verpackung
		SAE Flare					min	max		
		M	F							

Chiave montaggio meccanismo valvola / core remover (for all types) / clé montage mécanisme appareil de robinetterie / Schlüssel f. Schraderventil-montage

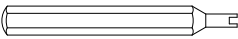
	8390/A	-	-	-	-	-	-	-	-	10
---	--------	---	---	---	---	---	---	---	---	----

Cappucci / caps with gasket / capuchons / kappen

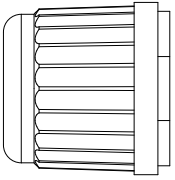
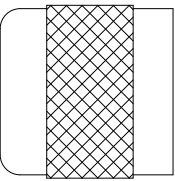
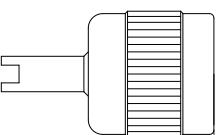
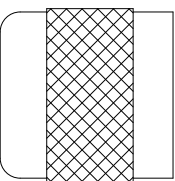
	8391/A	-	1/4"	-	-	35	-20	+100	-	100
	8392/A	-	1/4"	-	-	80	-20	+100	-	100
	8392/B (1)	-	1/4"	-	-	80	-20	+100	-	100
	8393/A	-	5/16"	-	-	80	-20	+100	-	100

(1) La chiave serve per il montaggio del meccanismo.

(1) The key needs to remove the valve core

(1) La clé sert pour le montage du mécanisme

(1) Der schlüssel dient zur montage des ventileinsatz

**ATTACCHI DI CARICA**  
**ACCESS FITTINGS**  
**RACCORD D'INTERVENTION**  
**SCHRADERVENTILE**

Disegno Drawing Dessin Zeichnung	N° catalogo Part number N° catalogue Katalog Nr.	Attacchi Connections Raccords Anschlüsse		Pressione statica Static pressure Pression statique Statischer Druck [bar]	Pressione operativa Working pressure Pression fonctionnement Betriebsdruck [bar]	PS [bar]	TS [°C]		Utilizzo Use Usage Nutzung	Confezione n° pz Package pcs Emballage Verpackung
		SAE Flare					min	max		
		M	F							

**Meccanismi valvola / spare valve cores / mécanismes / ventileinsatz**

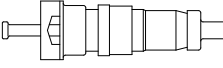
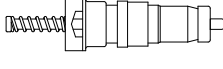
		8394/B (1)	-	-	35	30	-	-35	+100	R22 HFC	100
	<b>NEW</b>	8394/B1 (1)	-	-	60	55	-	-25	+150	HFC HFO HC	
		8395/A1 (2)	-	-	90	50	-	-32	+100	R22 HFC	100
		8395/A3 (2) (3)	-	-	90	50	-	-25	+130	HFC HFO HC	
		8395/A4 (2)	-	-	140	80	-	-35	+120	R744	
	<b>NEW</b>	8395/A5 (2) (3)	-	-	140	60	-	-45	+130	HFC HFO HC	

(1)  
Molla interna

(1)  
Inside spring

(1)  
Ressort intérieur

(1)  
Innenfeder

(2)  
Molla esterna

(2)  
Outside spring

(2)  
Ressort extérieur

(2)  
Aussenfeder

(3)  
NB: Non impiegare con R22

(3)  
NB: No use with R22

(3)  
NB: Incompatible avec R22

(3)  
NB: Nicht mit R22 verwendbar

**Collettori con attacchi di carica / manifolds with access fittings / collecteurs avec raccords de charge / verteiler mit füllanschlüssen**

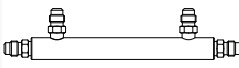
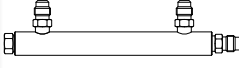
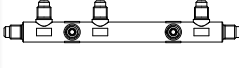
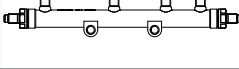
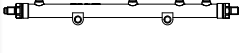
	9900/X47	1/4"	-	-	-	45	-	-	-	1
	9900/X87	1/4"	-	-	-	45	-	-	-	1
	9900/X81	1/4"	-	-	-	45	-	-	-	1
	9901/X43	1/4"	-	-	-	140	-	-	-	1
	9901/X44	1/4"	-	-	-	140	-	-	-	1







Lined writing area with horizontal blue lines.





Lined area for notes, consisting of 30 horizontal blue lines.





Lined writing area consisting of 30 horizontal blue lines.























GE-ED 01/2021-IT/EN/FR/DE



Castel can accept no responsibility for any errors or changes in the catalogues, handbooks, brochures and other printed material. Castel reserves the right to make changes and improvements to its products without notice. All trademarks mentioned are the property of their respective owners.  
The name and Castel logotype are registered trademarks of Castel Srl.  
All rights reserved.

Via Provinciale, 2-4  
20042 Pessano con Bornago (MI)

Tel. +39 02.957021  
Fax +39 02.95741317

info@castel.it  
castel.it